

DOCUMENT RESUME

ED 480 396

CE 085 405

TITLE Addressing Lead-Based Paint Hazards During Renovation, Remodeling, and Rehabilitation in Federally Owned and Assisted Housing. Student Manual for Use in HUD-Sponsored Lead-Safe Work Practices Training.

INSTITUTION Department of Housing and Urban Development, Washington, DC.; Environmental Protection Agency, Washington, DC. Office of Pollution Prevention and Toxics.

PUB DATE 2001-02-23

NOTE 299p.; Produced in conjunction with the Office of Healthy Homes and Lead Hazard Control. For the Instructor's Manual, see CE 084 923.

AVAILABLE FROM For full text: http://www.hud.gov/offices/lead/training/3r/3r_course.cfm.

PUB TYPE Guides - Classroom - Learner (051)

EDRS PRICE EDRS Price MF01/PC12 Plus Postage.

DESCRIPTORS Building Conversion; *Building Trades; *Environmental Standards; Facility Improvement; *Hazardous Materials; Instructional Materials; Labor Standards; *Lead Poisoning; Learning Modules; *Occupational Safety and Health; Painting (Industrial Arts); Pollution; Postsecondary Education; Public Health; *Safety Education; Secondary Education; Skilled Occupations; Vocational Education; Wastes; Work Environment

IDENTIFIERS Airborne Lead

ABSTRACT

This student manual comprises the United States Environmental Protection Agency's model renovation training course designed for renovation, remodeling, and painting contractors. It provides information regarding the containment, minimization, and cleanup of lead hazards during activities that disturb lead painted surfaces. Introductory material includes the agenda for this one-day course; course objectives; and training manual overview. This course has these five modules: why should I be concerned about lead-contaminated dust; talking to clients and planning work; set up your work space to contain lead dust; safe work practices; and clean up and check your work. Module components are an overview; informative material; activities and exercises; and module summary. Over one-half of the manual consists of these appendixes: Lead-Based Paint Safety Field Guide with illustrations of suggested methods for reducing, containing, and cleaning up dust in work areas; information about key Housing and Urban Development requirements regarding lead-based paint and responsibilities of key federal agencies; Protect Your Family from Lead in Your Home pamphlet; information about lead-based paint pre-renovation education rule (flyer; pamphlet; questions and answers; fact sheet; handbook; interpretive guidance); liability insurance summary fact sheet; Occupational Safety and Health materials; and supervisory and business issues. (YLB)

Reproductions supplied by EDRS are the best that can be made
from the original document.



U.S. Department of Housing and Urban Development

Addressing Lead-Based Paint Hazards During Renovation, Remodeling, and Rehabilitation in Federally Owned and Assisted Housing

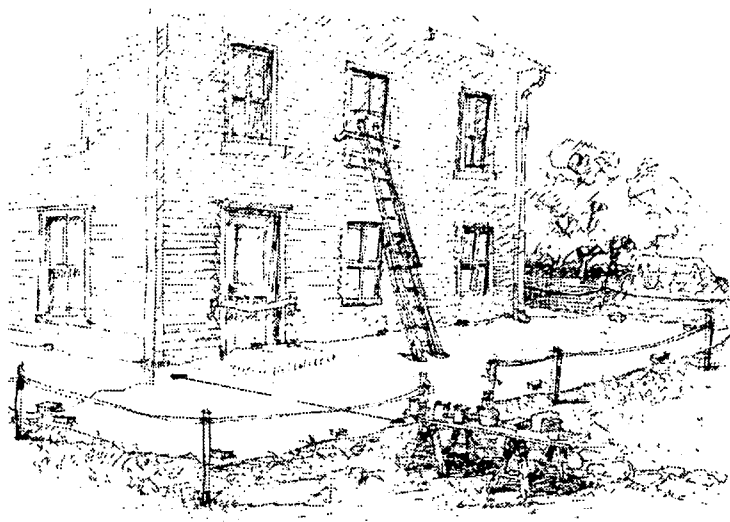
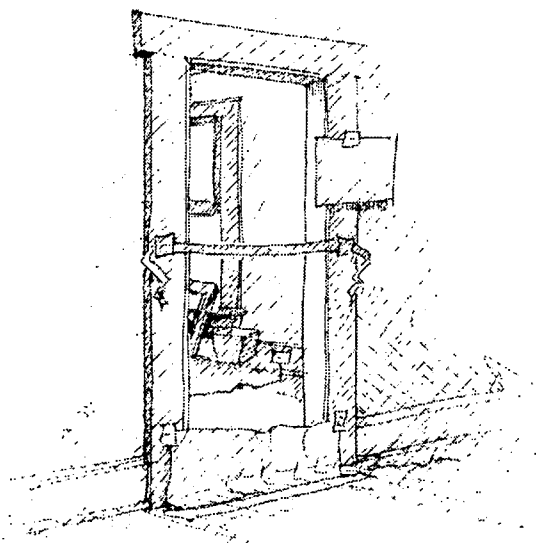

U.S. DEPARTMENT OF EDUCATION
Office of Educational Research and Improvement
EDUCATIONAL RESOURCES INFORMATION
CENTER (ERIC)

This document has been reproduced as received from the person or organization originating it.

Minor changes have been made to improve reproduction quality.

Points of view or opinions stated in this document do not necessarily represent official OERI position or policy.

FEBRUARY 23, 2001

STUDENT MANUAL

For Use in HUD-Sponsored Lead-Safe Work Practices Training

085 405





U. S. ENVIRONMENTAL
PROTECTION AGENCY
WASHINGTON, D. C. 20640

U. S. DEPARTMENT OF HOUSING
AND URBAN DEVELOPMENT
WASHINGTON, D. C. 20410-3000



Dear Trainee:

The U.S. Environmental Protection Agency (EPA) and the U.S. Department of Housing and Urban Development (HUD) thank you for enrolling in this training course, "Addressing Lead-Based Paint Hazards During Renovation, Remodeling, and Rehabilitation in Federally-Owned and Assisted Housing." This course is a part of HUD's efforts to implement its "Lead Safe Housing Rule," and applies to work conducted in federally-owned and assisted housing. The course is based on EPA's model training course, "Minimizing Lead-Based Paint Hazards During Renovation, Remodeling, and Repainting," which was modified to serve the training needs of this audience and includes the requirements of HUD's Lead Safe Housing Rule. EPA encourages the adaptation of its model curricula to address varying federal, state, and local requirements and supports HUD's adaptation of its model curriculum.

EPA's model renovation training course was developed for renovation, remodeling and painting contractors to provide important information regarding the containment, minimization, and cleanup of lead hazards during activities that disturb lead painted surfaces. The model training is part of EPA's effort to ensure that contractors and the public have the information they need to prevent lead poisoning.

Concurrent with the development of its model course, EPA is developing a regulation which may introduce training, certification, and work practice requirements for renovation and remodeling activities. This regulation will not be effective for several years and the specific requirements are not yet known. EPA will update the model course as necessary to reflect the regulation's specific requirements.

Thank you for helping to protect America's children from lead poisoning.

William H. Sanders, III
Office of Pollution Prevention and Toxics
U.S. Environmental Protection Agency

David E. Jacobs
Office of Healthy Homes and Lead Hazard Control
U.S. Department of Housing and Urban Development

COURSE AGENDA - LEAD SAFE WORK PRACTICES FOR RENOVATORS AND REMODELERS

7:30 - 8:00	Registration
8:00 - 8:15	Introduction and Welcome
8:15 - 8:30	Video "Moving Toward A Lead-Safe America"
8:30 - 9:45	Module 1: Why Should I Be Concerned About Lead-Contaminated Dust?
9:45 - 10:00	Break
10:00 - 11:00	Module 2: Talking to Clients & Planning Work
11:00 - 12:00	Module 3: Set-up Your Work Space to Contain Lead-Dust
12:00 - 1:00	Lunch-On your own
1:00 - 2:30	Module 4: Safe Work Practices
2:30 - 3:30	Module 5: Clean-up and Check Your Work
3:30 - 3:45	Break
3:45 - 4:15	Review
4:15 - 5:00	Exam and Evaluation

Addressing Lead-Based Paint Hazards During Renovation, Remodeling, and Rehabilitation in Federally Owned and Assisted Housing

TABLE OF CONTENTS

Module Title	Page Number
Introduction and Welcome	Page 1
Module 1: Why Should I Be Concerned About Lead-Contaminated Dust?	Page 1-1
Module 2: Talking to Clients & Planning Work	Page 2-1
Module 3: Set-up Your Work Space to Contain Lead-Dust	Page 3-1
Module 4: Safe Work Practices	Page 4-1
Module 5: Clean-up and Check Your Work	Page 5-1
Appendix 1: Lead Paint Safety: A Field Guide for Painting, Home Maintenance, and Renovation Work	A1-1
Appendix 2: Information About Key HUD Requirements Regarding Lead-Based Paint and the Responsibilities of Key Federal Agencies	A2-1
Summary of U.S. Department of Housing and Urban Development (HUD) Requirements for Safe Work Practices	
Responsibilities of Key Federal Agencies Regarding Lead-Based Paint	
Appendix 3: Protect Your Family from Lead in Your Home Pamphlet	A3-1

Addressing Lead-Based Paint Hazards During Renovation, Remodeling, and Rehabilitation in Federally Owned and Assisted Housing

Appendix 4: Information About Lead-Based Paint Pre-Renovation Education Rule	A4-1
Lead Pre-Renovation Education Rule Flyer	
Lead-Based Paint Pre-Renovation Regulation Trifold Pamphlet	
Pre-Renovation Lead Information Rule: Questions and Answers	
Pre-Renovation Lead Information Rule: Fact Sheet	
Lead-Based Paint Pre-Renovation Education Rule: Handbook	
Lead-Based Paint Pre-Renovation Education Rule: Interpretative Guidance Part 1	
Lead-Based Paint Pre-Renovation Education Rule: Interpretative Guidance Correction to Part 1	
Lead-Based Paint Pre-Renovation Education Rule: Interpretative Guidance Part 2	
Appendix 5: Liability Insurance Summary Fact Sheet	A5-1
Appendix 6: OSHA Respiratory Protection Standard Overview	A6-1
Appendix 7: OSHA Lead in Construction Standard Summary	A7-1
Appendix 8: OSHA Substance Data Sheet for Occupational Exposure to Lead	A8-1
Appendix 9: Overview of EPA and State Requirements	A9-1
Certification and Interim Controls	
Waste	
Appendix 10: Supervisory and Business Issues	A10-1

Addressing Lead-Based Paint Hazards During Renovation, Remodeling, and Rehabilitation in Federally Owned and Assisted Housing

02/23/2001



1

Introduction and Welcome

02/23/2001



2

Introduction Overview

- ◆ **Introductions**
- ◆ **Meeting facility and logistics**
- ◆ **Course objective**
- ◆ **Course manual**
- ◆ **Course agenda**

02/23/2001



3

Course Objectives

- ◆ **Minimize creation and dispersal of lead-contaminated dust and debris during**
 - Renovation and Remodeling
 - Rehabilitation
 - Maintenance
- ◆ **Protect residents, especially children, from exposure to lead-contaminated dust and debris**
 - Set-up and Containment
 - Safe Work Practices
 - Clean-up and Clearance

02/23/2001



4

Objective

- Upon completion of this course, participants will be able to perform renovation, remodeling, and rehabilitation in a manner that minimizes creation and dispersal of lead-contaminated dust and protects residents, especially children, from possible lead exposure.

Minimize dust and protect children

- This course will show contractors how to perform their work in a manner that creates the least amount of dust possible, and how to contain and clean up the dust that they do create so that it does not spread throughout the house or to neighboring properties.

Who can use this course

- The techniques discussed in this course apply to work performed by a variety of contractors and employees, including plumbers, electricians, residential renovators, remodelers, and painters.

This Course...

- ◆ **Is one of several courses that will enable you to perform R&R work in federally-funded housing**
- ◆ **Is not an abatement course**
- ◆ **Satisfies general lead training requirements of HUD**
 - Provides an introduction to the OSHA lead in construction standard
 - Comprehensive treatment of OSHA requirements requires additional training
- ◆ **May not satisfy state and local training requirements**



02/23/2001

5

Working in federally-funded housing

- If you perform R&R work on homes or residential buildings that receive federal funding and were constructed before 1978, such as public housing or rehabilitation funded by HUD, you must take a course on working with lead-based paint. A list of courses approved by HUD that meet this requirement can be found on the HUD Website at: <http://www.hud.gov/lea/lbptraining.html>. For more information on HUD requirements for working on residential properties with lead-based paint, see the appendix on HUD requirements.

Lead abatement training

- EPA defines abatement to mean measures intended to permanently eliminate lead-based paint hazards. This type of work requires special training, not provided by this course, and certification. Many states have defined the term abatement differently and have specific training and certification requirements, therefore, check with your state to obtain information about any state specific requirements. This training does not meet the training requirements of the OSHA Respiratory Protection Standard or project-specific training requirements found in OSHA.

Training Manual Overview

- ◆ Five modules
- ◆ Interactive exercises
- ◆ Appendices
- ◆ Lead Paint Safety Field Guide

02/23/2001



6

Modules

In addition to this Introduction and Welcome, there are five modules in this course:

- Module 1 Why Should I Be Concerned About Lead-Contaminated Dust?
- Module 2 Talking to Clients and Planning Work
- Module 3 Set-up Your Work Space to Contain Lead-Dust
- Module 4 Safe Work Practices
- Module 5 Clean-up and Check Your Work (Clearance)

Activities and Exercises

- The course includes activities and exercises to help you identify methods of reducing the amount of dust you create, and containing and cleaning up the dust you created. Many of the exercises and activities take place in small groups, so you will have an opportunity to share your experiences and ideas with others in the class.

Appendices

- As indicated in the table of contents, this manual has several appendices that provide extra information that will help contractors.

Field Guide

- This manual also provides you with a copy of the *Lead-Based Paint Safety Field Guide*. This handy Field Guide is easy to use and has illustrations of suggested methods for reducing, containing, and cleaning up dust in work areas. Take it with you to work.

Module 1

Why Should I Be Concerned About Lead-Contaminated Dust?

02/23/2001



U.S. Department of Housing
and Urban Development

1-1

Module 1 Overview

- ◆ Exercise
- ◆ Why is lead-contaminated dust a problem?
- ◆ Health risks and effects of lead?
- ◆ What is lead-based paint?
- ◆ How many homes contain lead-based paint?
- ◆ What is the government doing about lead-based paint?
- ◆ Summary

02/23/2001



Upon completion of this module, you will be able to explain

- Why we are concerned with lead-contaminated dust
- The health risks of lead to children and adults
- The federal regulations that affect lead-based paint

You will be viewing a video presentation, "Moving Toward a Lead-Safe America" at this time.

Why Are Dust and Debris a Problem?

- ◆ **Dust and debris can contain lead**
- ◆ **Lead-contaminated dust and debris are poisonous**
- ◆ **Small amounts of lead-contaminated dust can poison children and adults**
 - Children swallow it during ordinary play activities
 - Adults swallow or breathe it during work activities
- ◆ **Workers can bring lead-contaminated dust home and poison their families**



02/23/2001

Dust and debris from renovation, remodeling, and rehabilitation jobs in pre-1978 housing may contain lead

- Pre-1978 paint may contain lead.
- Renovation, remodeling, and rehabilitation jobs disturb paint that may contain lead.
- Any activity involving surface preparation, such as hand scraping, power sanding, the use of heat guns, and open flame burning, can generate significant amounts of dust. More complicated tasks such as removing building components and demolishing walls also can create a lot of dust.

Renovation, remodeling, or rehabilitation jobs that disturb lead-based paint can create a hazardous situation

- If proper precautions are not taken prior to and during jobs that may generate dust, workers, residents, and children may become lead-poisoned.

Workers may bring home lead-contaminated dust

- A worker's family may be most at risk from being exposed to lead-contaminated dust because dust can be tracked home and into vehicles on the worker's clothing and shoes.

Small amounts of lead-contaminated dust can poison

- A tiny amount of lead can be extremely harmful. A lead-contaminated paint chip the size of your fingernail contains enough lead to poison an adult.
- Lead particles are often so small that you cannot see them, and yet you can breathe or swallow them. Smaller dust particles that are inhaled or swallowed are more easily absorbed by the body than larger particles, and can therefore cause poisoning more easily.

MODULE 1 EXERCISE

Objective: Identify common work practices that produce a lot of dust and debris.

Length: Total Time: 20 minutes.

Directions: In groups of 3 to 5 take 10 minutes to answer the questions below.
Assign one person to report your group's answers to the rest of the class.

1. Rank the work practice descriptions according to the amount of dust and paint chips you think they make. In the table below, under the column labeled Rank, write:
 - a. 1 next to the work practice that makes the most dust and debris.
 - b. 2 next to the work practice that makes the second most amount of dust and debris.
 - c. 3 next to the work practice that makes the third most amount of dust and debris.
 - d. Continue until you have ranked each work practice according to how much dust and debris you think it will make. A smaller number means that you think the work practice will create more dust or debris than a larger number.

If you think that some work practices make about the same amount of dust or debris you can give them the same rank. If you think that each practice makes different amounts of dust, rank them from 1 to 7.

Work Practice Description	Rank
A. Using a power sander with no vacuum attachment to remove interior paint from a plaster wall.	
B. Hand sanding a small (less than 2 square feet) area for surface preparation on an interior room where the paint is in good condition.	
C. Ripping out old kitchen cabinets in a 50 year-old house where the paint on the walls and cabinets is in good condition (e.g., it is not peeling or flaking).	
D. Repairing a sticking window. Loosen the painted sashes, remove inside stop molding, remove top and bottom sash, use a power planer to remove old paint, reglaze and repair the sash as necessary, repair and paint the jamb, reinstall the sash.	
E. Removing old carpeting placed over a hardwood floor in one room.	
F. Demolishing one interior wall using hand or power tools.	
G. High pressure power washing or hydro blasting exterior paint.	

MODULE 1 EXERCISE

2. For the work practice(s) that you ranked #1 (it makes the most dust and debris), tell why you think it makes the most dust and debris.

3. For the work practice(s) that you ranked last (it makes the least amount of dust and debris) tell why you think it makes the least amount of dust and debris.

4. If you actually did any of the jobs described above, what would you do to clean up when the job was finished?

Health Risks of Lead

◆ Very hazardous to children

- Reading and learning difficulties
- Behavioral problems
- Difficulty paying attention and hyperactivity
- May result in seizures, coma, and death

◆ Hazardous to pregnant women

- Damage to fetus

◆ Also hazardous to workers and other adults

- Loss of sex drive
- Physical fatigue

02/23/2001



1-5

Children, particularly children under six, are most at risk from small amounts of lead

- Children absorb more lead than adults. Because children's brains and nervous systems are still developing, lead causes irreversible brain, nervous system, and organ damage. This can lead to:
 - Reading and learning difficulties in school
 - Behavioral problems
 - Difficulty paying attention and hyperactivity
- In some cases, exposure to lead may have devastating health effects including seizures, coma, and death.
- Children are at a greater risk than adults because during normal and frequent playing or hand-to-mouth activity, children may swallow or inhale dust from their hands, toys, food, or other objects.
- **Among adults, pregnant women are especially at risk from exposure to lead**
- Changes in a woman's body during pregnancy may cause lead stored in her bones to be released into her blood.
- Lead can then be passed from the mother to the fetus. Lead poisoning can cause:
 - Miscarriages
 - Premature births
 - Low birth weight

Health effects of lead in adults include

- | | |
|--|---|
| ▪ Loss of sex drive | ▪ Miscarriages in pregnant women |
| ▪ Physical fatigue, lack of coordination, dizziness, muscle or joint aches | ▪ Headaches and memory loss |
| ▪ Kidney damage or failure | ▪ Nausea and stomach aches |
| ▪ Damage to male and female reproductive organs | ▪ Heart disease and high blood pressure |

Lead Poisoning

◆ Lead poisoning does not always have obvious symptoms

- Symptoms are easily misdiagnosed, thus delaying effective treatment and increasing likelihood of permanent physical and mental damage
- The primary way to determine lead poisoning is to take a blood lead level test.



02/23/2001

1-6

Lead poisoning does not always have obvious symptoms

- Lead poisoning often has no obvious symptoms, so symptoms are frequently attributed to other causes.
- Specific symptoms that people with lead exposure sometimes complain of include:
 - Headache
 - Stomach ache
 - Irritability
 - Fatigue
 - Loss of appetite
 - Pain in joints
- Because many symptoms are vague or similar to flu symptoms, parents may not get immediate medical attention for their children. This is critical for young children. The longer lead remains in the body of a young child, the higher the risk of permanent damage.
- The best way to determine if lead is present in the body is by testing a person's blood.

Blood Lead Level

- Because lead poisoning does not always have symptoms, the most common way to measure the amount of lead in your blood is the Blood Lead Level (BLL) test. The BLL test:
 - Measures the amount of lead that is circulating in your blood.
 - Tells you about your exposure to lead in the last 2-3 weeks.
 - Does not tell you the total amount of lead in your body.
 - Does not tell you if any long-term damage has occurred.
 - A blood lead level above **10 ug/dl** is not safe for children or for women during pregnancy. The Centers for Disease Control and Prevention consider this to be the "level of concern." A level of 39 ug/dl or less may mean that damage to your body is occurring, even if you have no symptoms. A level of 40 to 49 ug/dl means that serious health damage may occur. A level of 50 ug/dl or greater means that severe health damage is likely, may be permanent, and may occur quickly.
 - HUD's "environmental intervention blood lead level" means a confirmed concentration of lead in whole blood equal to or greater than 20 ug/dl for a single test or 15-19 ug/dl in two tests taken at least 3 months apart. The source of this level was research from the Centers for Disease Control and Prevention (CDC.)

What Is Lead-Based Paint?

◆ Lead-based paint is

- Any paint or surface coating that contains at least 0.5% lead or 5,000 ppm by dry weight or 1.0 mg/cm²
- Some states regulate paint with different concentrations of lead

◆ Why was lead used in paint?

- Primary pigment
- Added color
- Durability and corrosion control
- Drying agent



1-7

02/23/2001

Lead-Based Paint

- Lead-based paint is any paint or other surface coating that contains lead equal to or greater than 0.5 percent or 5,000 parts per million by weight or 1.0 mg/cm² as measured by laboratory analysis or X-ray fluorescence (XRF).
- Paint with concentrations of lead lower than the standard definition above can still cause health problems.

Some states regulate paint with lower concentrations of lead

- You should check with your state to see if the state has requirements that are more stringent than the federal requirements.

Why was lead added to paint?

- Lead was added to paint for color and durability. Lead-based paints stood up to wear and tear, temperature and weather changes, and resisted mold and mildew in moist areas.
- Before the 1950's concentrations of lead in paint were as high as 50 percent by weight. From about 1950 to 1973, the concentration of lead in paint was reduced as other pigment materials became more popular.

Lead-based paint was banned from residential use in 1978

- In 1978 the Consumer Products Safety Commission banned the sale of lead-based paint for residential use. In practice, this means that homes built in 1978 could still have used lead-based paint because existing supplies of paint containing lead would still have been available.

How Widespread is Lead in Housing?

Year House Was Built	Percent of Houses with Lead-Based Paint
----------------------	---

Before 1940	87 percent
-------------	------------

1940-1959	69 percent
-----------	------------

1960-1978	24 percent
-----------	------------

All Housing	40 percent
-------------	------------



U.S. Department of Housing
and Urban Development

02/23/2001

1-8

- **Source of data in table above:** HUD Report on the National Survey of Lead-Based Paint in Housing, 2001.

Homes built before 1960

- Homes built before 1960 are more likely than homes built after 1960 to contain higher concentrations of lead and to have deteriorated paint surfaces. In the late 1950's paint companies began to use less lead.

Homes built before 1978

- **Play it safe.** You should assume that any house built before 1978 or earlier contains lead-based paint unless the house has been tested for lead and the results indicate that the house does not contain lead-based paint.

What Is Being Done About Lead?

- ◆ **Lead-based paint was banned from residential use in 1978**
- ◆ **Programs affecting renovation, remodeling, and rehabilitation**
 - EPA: Contractors distribute lead pamphlet before renovation
 - HUD: Grants for Lead Hazard Control in private low-income housing; Lead Safe Housing Rule for Federally owned or assisted housing
 - HUD and EPA: Disclosure before lease or sale
 - OSHA: Worker protection standards for lead in construction
 - CDC: Testing children's blood
- ◆ **Education**
- ◆ **Local government programs and regulations**



02/23/2001

1-9

Federal Regulations and Standards

Environmental Protection Agency (EPA) Responsibilities:

•EPA is responsible for protecting human health and safeguarding the natural environment. Under the Toxic Substances Control Act (TSCA), Title IV, EPA has developed or is developing regulations and standards for lead-based paint services and training.

Department of Housing and Urban Development (HUD) Responsibilities:

•HUD is responsible for setting requirements for federally owned or assisted housing and operating the Lead Hazard Control Grant Program for privately owned low-income housing. Most pre-1978 properties receiving HUD funds are subject to HUD requirements for lead-based paint.

Occupational Health and Safety Administration (OSHA) Responsibilities:

•OSHA is responsible for developing standards to protect worker health and safety on the job.

Centers for Disease Control and Prevention (CDC) Responsibilities:

•CDC is responsible for promoting health and quality of life by preventing and controlling disease, injury, and disability.

See Appendix 2 for more information about the regulations and standards set by the four agencies above.

Education

Training courses like this one inform housing providers and renovation, remodeling, and rehabilitation contractors about the potential dangers of lead-based paint and how to prevent potential problems. Both EPA and HUD offer outreach materials and training courses on aspects of lead-based paint.

EPA and HUD information and materials can be obtained on the Internet (www.epa.gov/lead/nlic.htm) and (www.hud.gov/offices/lead) or by contacting the National Lead Information Center at 800-424-LEAD (800-424-5323). CDC guidelines and materials can be obtained on the Internet (www.cdc.gov) or by contacting 800-311-3435.

Title X (“Ten”) and Implementing Regulations

◆ The Residential Lead-Based Paint Hazard Reduction Act of 1992 (Title X of the Housing and Community Development Act of 1992)

◆ Goals:

- To reduce and prevent childhood lead poisoning
- To ensure that LBP hazards are integrated into government housing policies
- Encourage promising and cost-effective methods of hazard reduction
- Educate the public



02/23/2001

1-10

The Residential Lead-Based Paint Hazard Reduction Act of 1992 (Title X) was established by Congress to reduce the risk of lead poisoning in Federal Housing stock. Some of the general purposes of this law were to prevent lead poisoning, insure that Federal policies incorporate lead hazards reduction measures, educate the public and develop an infrastructure capable of dealing with lead in housing (e.g., trained and certified professionals such as lead abatement contractors). All lead regulations from federal agencies such as the Environmental Protection Agency (EPA), the Department of Housing and Urban Development (HUD), and the Occupational Safety and Health Administration (OSHA) were developed based on direction found in Title X. This document is the cornerstone of the national lead program.

Title X - Section 402 (c) Renovation and Remodeling

◆ Requires EPA to:

- Develop guidelines for the conduct of renovation and remodeling activities which may create a risk of exposure to dangerous levels of lead
- Study the extent to which people engaged in renovation and remodeling activities are exposed to lead, or disturb lead and create a lead-based paint hazard
- Revise lead-based paint activities regulations to apply them to renovation and remodeling activities that create a lead-based paint hazard



U.S. Department of Housing
and Urban Development

1-11

02/23/2001

EPA Training and Certification (Sections 402/404)

◆ Individuals performing specified lead-based paint activities must be trained in EPA or State accredited training programs and certified. EPA certifies the following disciplines:

- Inspector
- Risk Assessor
- Project Designer
- Abatement Worker
- Abatement Supervisor

02/23/2001



The Environmental Protection Agency (EPA) is the agency leading the development of training requirements for all lead disciplines. In addition to training courses for certification in lead-based paint activities, this course is another example of the type of training that EPA supports to accomplish Title X's goal of developing infrastructure and in educating the public on lead issues.

Title X directs EPA to develop training and certification requirements for lead professions. In response to this EPA has published 40 CFR Part 745 (Also known as the 402/404 Rule). This rule establishes specific training course content, model curricula, certification requirements, and work practice standards for the following lead disciplines:

- Inspector
- Risk Assessor
- Project Designer
- Abatement Worker
- Abatement Supervisor

Your state also may have specific requirements about certification or licensing of lead professionals, so you may need to contact your State lead certification program regulator. Refer to Appendix 9 for more information.

Title X - Section 406(b)

◆ Lead hazard information pamphlet

- 800-424-LEAD
- www.epa.gov/lead
- www.hud.gov/offices/lead

◆ Renovation of pre-1978 housing:

Renovators, multi-family housing owners, managers receiving compensation shall provide the lead hazard control pamphlet to the owner and/or occupant prior to such activity.

02/23/2001



The pamphlet below is the one which **must** be given out. It may be obtained from the National Lead Information Center at 1-800-424-LEAD (5323) or by download from www.epa.gov/lead or www.hud.gov/offices/lead.

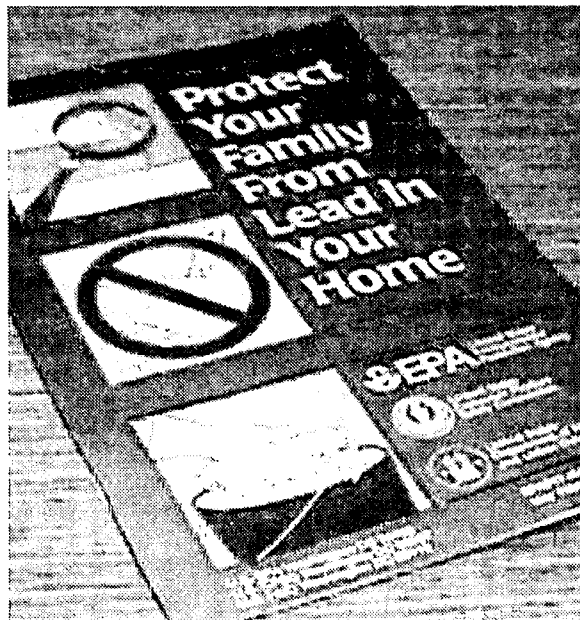

Title X - Section 406(b) (cont.)

- ◆ **No more than 60 days before the start of the activity; at least 7 days if sending by certified mail**
- ◆ **Written acknowledgement; records retention for 3 years**
- ◆ **Covers work in the dwelling unit, common areas**
- ◆ **Exemptions: repairs of areas less than or equal to 2 ft² , emergency renovations or written documentation of no LBP via certified inspector**

02/23/2001



Section 406(b) is an important part of Title X for companies performing renovation or remodeling work. It requires communication with the owner about lead before work begins.

In an informational pamphlet about this regulation, EPA describes “emergency renovations” as: “unplanned renovations or activities done in response to a sudden, unexpected event which if not immediately attended to presents a safety or public health hazard or threatens property with significant damage.” They provide two examples of emergency renovations:

- Renovations to repair damage from a tree that fell on a house
- Renovations to repair a pipe break in an apartment complex

Title X - Section 1018

◆ The HUD/EPA Disclosure Rule requires:

- “Protect Your Family from Lead in Your Home” pamphlet be given to people before they lease or buy pre-1978 housing
 - Renovators give this same pamphlet before starting work
- Sellers or landlords disclose information about any known lead-based paint or lead-based paint hazards before selling or renting a home.
- Buyers have up to 10 days to check for lead hazards



02/23/2001

Section 1018 applies to sellers or lessors of pre-1978 housing. It requires that sellers disclose information about lead to potential buyers. They must disclose information they have about the presence of lead-based paint or LBP hazards. The buyer has 10 days to obtain an inspection or risk assessment. Owners of rental housing must disclose such information to potential renter before a lease is signed. This pamphlet is the same pamphlet that renovators and remodelers provide to clients before work begins.

HUD's Lead Safe Housing Rule

- ◆ Pre-1978 housing receiving HUD or other Federal assistance
- ◆ Pre-1978 Federally owned housing being sold
- ◆ Required activities vary by type of assistance

federal

Part II

Department of
Housing and Urban
Development

24 CFR Part 25, et al.
Requirements for Notification, Evaluation
and Remediation of Lead-Based Paint
Hazards in Federally-Owned Residential
Property and Housing Receiving Federal
Assistance: Final Rule



U.S. Department of Housing
and Urban Development

1-16

02/23/2001

The Section 1012/1013 regulation ("Lead Safe Housing Rule") covers Federally assisted housing and Federally owned housing which is being sold. Housing owned and operated by a Federal agency other than HUD is not covered by this regulation.

The word HOUSING is highlighted because the regulation does not cover "Child Occupied Facilities" unless they are part of a property covered by the regulation.

HUD's Lead Safe Housing Rule: Interim Controls

- ◆ Training requirements for personnel
- ◆ Includes occupant protection and clearance
- ◆ Activities include:
 - Paint stabilization
 - Friction or impact surfaces
 - Chewable surfaces
 - Dust-lead hazard control
 - Soil-lead hazard control



02/23/2001

Interim controls are defined by HUD as, "a set of measures designed to reduce temporarily human exposure or likely exposure to lead-based paint hazards. Interim controls include, but are not limited to, repairs, painting, temporary containment, specialized cleaning, clearance, ongoing lead-based paint maintenance activities, and the establishment and operation of management and resident education programs."

Risk assessors may recommend interim controls for controlling lead-based paint hazards.

Note: HUD's Lead Safe Housing Rule's definition of paint stabilization includes repainting and correcting the source of damage.

HUD Lead Hazard Criteria

•Deteriorated paint

•Lead in dust (clearance/risk assessment)

Floors	40	µg/ft ²
Interior window sills	250	µg/ft ²
Troughs (clearance only)	400	µg/ft ²

•Lead in bare soil (risk assessment)

Play areas	400	µg/g
Other soil	1,200	µg/g

HUD's Lead Safe Housing Rule: Safe Work Practices

◆ Included in:

- Ongoing LBP Maintenance
- Paint stabilization
- Rehabilitation
- Standard treatments

◆ Prohibited methods

◆ Occupant protection and worksite preparation

◆ Specialized cleaning

◆ De minimis levels (24 CFR 35.1350)



02/23/2001

The Lead Safe Housing Rule requires lead safe work for the activities listed on the slide. It specifies prohibited practices, requirements for protecting occupants, preparing the work site. Special cleaning techniques must be used, and clearance achieved.

All areas of deteriorated paint must be repaired. However, if an area of deteriorated paint is below the "de minimis" amount, it means it is a small area and lead safe work practices and clearance are not required.

The de minimis levels are:

- 20 square feet on exterior surfaces
- 2 square feet in any one interior room or space
- 10 percent of the total surface area on an interior or exterior type of component with a small surface area

HUD's Lead Safe Housing Rule: Clearance Examination

- ◆ **Visual Assessment**
- ◆ **Dust sampling**
 - Interim Dust Lead standards
 - Will be changed to EPA's standards when effective
- ◆ **Certified, or trained and supervised personnel**

02/23/2001



Visual Assessment means looking for, as applicable, deteriorated paint, visible surface dust, debris and residue as part of a risk assessment or clearance examination, or completion or failure of lead hazard reduction.

Before a supervisor releases an area for clearance test to be performed, the supervisor should do his own visual inspection of the area to make sure it is clean.

HUD's Lead Safe Housing Rule: Dust Lead Standards

HUD uses these clearance standards:

- ◆ Floors 40 $\mu\text{g}/\text{ft}^2$
- ◆ Interior window sills 250 $\mu\text{g}/\text{ft}^2$
- ◆ Window troughs 400 $\mu\text{g}/\text{ft}^2$

Need to clean carefully to meet these standards.

02/23/2001



1-20

These are EPA's clearance standards, which HUD uses.

Know The HUD Rule!

You may obtain a copy of the regulation from NLIC at (1-800-424-LEAD) to ensure an understanding of the requirements.

02/23/2001



Individuals performing renovation, remodeling, and rehabilitation in pre-1978 housing need to understand the HUD Lead Safe Housing Rule. Appendix 2 contains summary fact sheets on this regulation.

HUD's Lead Hazard Control Grant Program

- ◆ Targeted to private homes owned or occupied by low-income families
- ◆ Since 1993, the program has:
 - Provided 177 grants totaling \$552 million to 112 State and local governments in 35 states and DC
 - Educated families on how to eliminate or reduce children's lead exposure.



U.S. Department of Housing
and Urban Development

1-22

- 02/23/2001

The HUD Lead Hazard Control Grant Program has completed lead hazard reduction in over 30,000 homes. Most of the work done in these homes consisted of lead interim controls. More information on this program may be found by visiting the HUD Office of Healthy Homes and Lead Hazard Control web site at www.hud.gov/offices/lead.

Occupational Health and Safety Administration (OSHA) Lead Regulations

- ◆ 29 CFR 1926.62 Lead in Construction
- ◆ 29 CFR 1926.59 Hazard Communication for Construction
- ◆ 29 CFR 1910.1200 Hazard Communication for General Industry
- ◆ Other Construction Safety Standards



02/23/2001

The major OSHA regulations pertaining to lead are listed on this slide. A comprehensive treatment of OSHA requirements requires additional training. More detailed information on the lead in construction and hazard communication standards are included in this manual. Information on the OSHA Lead in Construction Standard are located in Appendix 7. For information on the Hazard Communication standard, see Appendix 8.

29 CFR 1926.62 The OSHA Lead in Construction Standard went into effect June 3, 1993. It applies to all workers doing construction work who may be exposed to lead on the job. This specifically includes repair and renovation work. This manual covers the major sections of the standard on following slides.

29 CFR 1910.1200 (General Industry) and 29 CFR 1929.59 (Construction) The OSHA Hazard Communication Standards cover all individuals that work with or around hazardous chemicals. It allows employees to gain access to information about the hazards of substances they work around, safe work practices and how to protect themselves. They require employees receive training about the specific chemicals in a workplace, labeling and Material Safety Data Sheets.

Employees are covered by one or more of these regulations if lead in their workplace is disturbed.

OSHA Lead in Construction Standard

Requirements are exposure-based and task-based. The regulation covers:

- ◆ **Demolishing or salvaging structures where lead or materials containing lead are present**
- ◆ **Removing, encapsulating or enclosing materials containing lead**



02/23/2001

1-24

Some of the requirements of this regulation are based on the work that is done; others are based on employees' potential for exposure. Employers need to be familiar with all of these requirements.

The OSHA Lead in Construction Standard covers a broad range of work activities. This standard covers every phase of construction work, if employees have the potential for occupational lead exposure. The standard specifically states, "All construction work excluded from coverage in the general industry standard for lead by 29 CFR 1910.1025(a)(2) is covered by this standard." It also states, "Construction work is defined as work for construction, alteration and/or repair, including painting and decorating."

Demolition or salvage of structures where lead or materials containing lead are present and removal, enclosure or encapsulation may be large-scale projects are covered under this regulation. The terms, "removal, enclosure, or encapsulation" are also used to refer to activities done by specialty lead abatement contractors who are certified to do this type of work, so this standard clearly applies to those abatement activities as well.

Construction Standard: Scope

- ◆ **New construction, altering, repairing, or renovating structures or substrates (or portions of them) that contain lead or materials containing lead**
- ◆ **Installing products containing lead**
- ◆ **Contamination or emergency clean-up**

02/23/2001



Many R&R activities are covered under this regulation. Despite the fact that the Consumer Product Safety Commission limits the amount of lead that can be in paint for residential use, other products used in new construction still contain lead (e.g., sheet lead used in roofing.) This regulation covers structures or substrates that contain lead, installation of products containing lead or clean-up activities. Therefore, R&R contractors, plumbers, roofers, welders, painters, and a host of other types of firms are covered by this regulation because they use lead.

OSHA's definition of "lead" is very important. OSHA defines lead as, "metallic lead, all inorganic lead compounds, and organic lead soaps. Excluded from this definition are all other organic lead compounds." This means that OSHA has not limited employee exposure to lead from paint. OSHA does not put a limit on how much lead needs to be in a product for it to be a potential problem for employees. It means that any amount of lead from any source on a job site could be a problem. That is where knowledge about the products and activities on a worksite becomes important, and why training is a requirement in many OSHA regulations.

OSHA does not define or regulate "lead-based paint." This is an EPA/HUD term. OSHA protects employees from exposure to lead from any source or during "lead-related trigger tasks." These will be discussed further on page 1-27.

Construction Standard: Scope (cont.)

- ◆ **Transporting, disposing, storing or containing lead or materials containing lead where construction activities are performed;**
- ◆ **Maintenance operations associated with the activities mentioned above**

02/23/2001



Construction work involving moving or transport of lead or materials containing lead is also covered under this regulation. This includes disposing or storing of lead materials on a job site and associated maintenance work, including sorting waste materials, putting plastic drop cloths in bags for disposal, carrying bags of waste or building components to a dumpster, or other similar activities.

Construction Standard: Key Concepts

- ◆ **Competent Person**
- ◆ **Exposure Assessment**
- ◆ **Action Level: 30 $\mu\text{g}/\text{m}^3$ of lead in air**
- ◆ **Permissible Exposure Limit (PEL):
50 $\mu\text{g}/\text{m}^3$ of lead in air**

02/23/2001



OSHA requirements depend on the level of lead exposure a worker has on the job. A “*competent person*” is responsible to identify existing and predictable lead hazards and who has the authority to correct them. The competent person is responsible for assessing the job and having air samples taken in the worker’s breathing zone and analyzed. Workers must be protected during this “*exposure assessment*.” The employer is required to give employees the results of the air sampling within five working days of receiving the results. If a worker’s potential for exposure is high, OSHA regulations are more stringent. These requirements are designed to protect workers with potential for exposure to lead.

“*Action Level*” means employee exposure, without regard to the use of respirators, to an airborne concentration of lead at or above 30 micrograms per cubic meter calculated as an 8-hour time-weighted average. This means the exposures over a shift are averaged. The employer must provide medical surveillance and training when employees are exposed at the action level. Respirators, protective clothing, and other more restrictive procedures are not required **AT THIS LEVEL OF EXPOSURE**.

“*Permissible Exposure Limit*” means an employer is not allowed to expose an employee to lead at concentrations above 50 micrograms per cubic meter of air averaged over an 8-hour time period. If you work in an area with more lead in the air than this level, the employer must reduce your exposure.

Lead-related trigger tasks are divided into three groups:

Group 1: Manual demolition of structures, dry manual scraping or sanding, using a heat gun, power tool cleaning with dust collection systems, spray painting with lead-based paint. **NOTE:** *Group 1 activities, prior to initial assessments, require employee protection as if lead exposure is greater than 1-10 times the PEL (50 to 500 $\mu\text{g}/\text{m}^3$.)*

Group 2: Using lead-based mortar, burning lead, rivet busting, power tool cleaning without dust collection systems, movement or removal of abrasive blasting containment, clean up activities where dry expendable abrasives are used. **NOTE:** *Group 2 activities, prior to initial assessments, require employee protection as if lead exposure 10-50 times the PEL (500 to 2500 $\mu\text{g}/\text{m}^3$.)*

Group 3: Abrasive blasting, welding, torch cutting, torch burning. **NOTE:** *Group 3 activities, prior to initial assessments, require employee protection as if lead exposure is greater than 50 times the PEL (greater than 2500 $\mu\text{g}/\text{m}^3$.)*

OSHA’s available data has identified high lead exposures related to “trigger” tasks. Employers must provide a higher level of protection when employees perform lead-related trigger task until the exposure assessment shows that your exposure is below the PEL.

Employer Requirements: Action Level and PEL

◆ At or Above the Action Level

- Training & Medical Surveillance Required

◆ Above the PEL, or for “Trigger Tasks”

If employees exposed above PEL, or do Group 1, 2 or 3 work until exposure assessment is completed, the employer must provide:

- Housekeeping
- Respiratory Protection, Protective Clothing/ Equip.
- Hygiene Facilities (showers, if feasible)
- Medical Surveillance (blood tests reviewed by doctor)
- Medical Removal (if blood lead level too high)
- Employee Information and Training



U.S. Department of Housing
and Urban Development

1-28

02/23/2001

Many of the work practices covered in this training course are also required by OSHA, such as good housekeeping practices, working clean and use of good hygiene by employees. *Note: Specific training topics in Appendix 7 of this text.*

If an employee is exposed above the Permissible Exposure Limit (PEL) or performs “trigger tasks,” and the employer has not performed an initial exposure assessment the employer must provide more protection including engineering controls and work practice controls to reduce exposures below the PEL. This protection includes:

- Good housekeeping includes maintaining all workplace surfaces free of lead dust accumulations. Good housekeeping involves a regular schedule to remove accumulated lead dust and debris, cleaning floors and other surfaces, vacuums with HEPA filters; (shoveling, dry or wet sweeping shall only be used where vacuuming has been tried and is ineffective), and HUD prohibits the use of compressed air to remove lead from surfaces. Note: Housekeeping is required for all lead jobs.
- The proper respirator for the job, respirator fitting and training; protective clothing such as coveralls, gloves, hats, shoes or disposable booties for the shoes, face shields or other appropriate equipment; no blowing or shaking of contaminated clothing, closed container for used protective clothing.
- Facilities for hand and face washing; showering, if feasible.
- An accessible lunchroom facility or eating area must be available and as free from contamination as practical.
- Initial blood tests reviewed by a physician must be provided if an employee does any Group 1, 2 or 3 tasks (“trigger tasks”) or if the employee is exposed at or above the action level any one day. Ongoing medical surveillance is required if an employee exposed to lead at or above the action level for more than 30 days in a 12-month period.
- Removal from lead work area if blood lead level is too high (50 ug/dl).
- The OSHA standard prohibits chelation to prevent lead poisoning (a chemical to remove lead from the body).

Construction Standard: Additional Provisions

- ◆ Compliance plan
- ◆ Signs for work above the PEL
- ◆ Recordkeeping
- ◆ Monitoring observation

02/23/2001



OSHA requires employers develop a lead compliance plan to state how they plan to comply with the lead requirements. A sample lead compliance plan can be downloaded from the HUD web site at www.hud.gov/offices/lead. It is located in Chapter 9 of the HUD Guidelines for the Evaluation and Control of Lead Hazards.

Note: OSHA requires the the development and implementation of a written compliance plan prior to the commencement of the job where employee exposure to lead without the use of respiratory protection will be in excess of the PEL.

The regulation also requires signs in the work area where employees are exposed at or above the PEL. Signs must be kept clean and illuminated. The sign must say:

**WARNING
LEAD WORK AREA
POISON
NO SMOKING OR EATING**

The employer must keep records of all employees, social security numbers, job duties, exposure assessments, type of respiratory protection worn on the job site, medical surveillance and medical removals. The employer must also keep good records of all lead exposure monitoring, medical surveillance, and medical removals. Refer to 29 CFR 1926.62(n) for specific information.

Employers must offer employees or their designated representative the opportunity to observe any monitoring of employee exposure to lead. Employees must be provided the opportunity to observe all steps related to the monitoring of lead, and are entitled to an explanation of the measurement procedure, the right to record results or receive copies of results when returned from the lab.

Additional OSHA Regulations

- ◆ **Respiratory Protection:**
29 CFR 1910.134
- ◆ **Personal Protective Equipment:**
29 CFR 1910.132
- ◆ **Sanitation: 29 CFR 1926.27**
- ◆ **Other construction safety standards**



02/23/2001

For information on the OSHA Respiratory Protection Standard Overview, see Appendix 6. For copies of OSHA standards, go to www.osha.gov.

Many OSHA regulations have similar requirements:

- Keep work area clean and free of hazards
- Assess the job and protect employees
- Use safe work practices
- Provide hygiene facilities for washing hands and face, showering if feasible
- Train employees about workplace hazards
- Do the job right and keep good records
- Access to medical and exposure records

Other construction safety standards include fall protection; scaffolding; ladder safety; eye, head and foot protection; walking/working surfaces; lockout/tagout; respiratory protection; electrical safety, etc.

These standards may require additional training.

Lead Information Resources

- ◆ EPA - <www.epa.gov/lead>
- ◆ HUD Lead Web site - <www.hud.gov/offices/lead>
- ◆ OSHA - <www.osha.gov>
- ◆ National Lead Information Center
 - Copies of the regulation
 - 1-800-424-LEAD
- ◆ Lead professionals listing
 - <www.leadlisting.org>



02/23/2001

You can get the information you will need about Federal requirements from these sources. Firms can contact the Leadlisting and be listed as a Lead Safe Renovator if you wish.

Module Summary

◆ Now you know

- Why we are concerned with lead-contaminated dust
- The health risks of lead to children and adults
- The regulations that affect lead-based paint

02/23/2001



U.S. Department of Housing
and Urban Development

1-32

The modules in the rest of the course describe how proper set-up and containment, safe work practices, and clean up techniques leave less lead-contaminated dust and debris than standard renovation, remodeling, and rehabilitation work practices.

Module 2

Talking to Clients and Planning Work

02/23/2001



2-1

Module 2 Overview

◆ **At the end of this module, you will be able to answer the following questions:**

- Do I need to use lead safe work practices?
- How can I communicate information about the associated planning, cost, and time demands to the residents?
- Should the paint be tested before starting work?

02/23/2001



2-2

Planning Ahead

- You should also talk to the residents about why you are performing lead safe work practices and describe what the residents can do to help prevent the spread of dust both before you start the project and while you are working.
- To safely work in homes with lead-based paint, it is essential that you plan a strategy to reduce the creation of dust and contain any dust created. The time invested in these activities will ensure your project is conducted safely with regards to lead dust hazards and expedite the cleanup process.

What are Your Supervisor's or Agency's Responsibilities?

- ◆ Under federal law, if disturbing more than 2 sq. ft. of painted surfaces in pre-1978 housing, you **MUST**:
 - Give residents copies of the pamphlet *Protect Your Family From Lead In Your Home* (see attachments)
 - Get confirmation that residents received the pamphlet
 - Keep confirmation records for three years
- ◆ **See *The Lead Pre-Renovation Education Rule (40 CFR Part 745) or Lead-Based Paint Poisoning Prevention In Certain Residential Structures (24 CFR Part 35) for confirmation forms and guidance (see attachments)***

02/23/2001



2-3

Legal Obligations

- Federal law requires contractors to tell occupants about the risks of lead-based paint before non-emergency repair, maintenance, and home renovation work begins. This law applies to all work on surfaces greater than 2 square feet per component. Contractors **MUST**:
 - Give residents a copy of the pamphlet *Protect Your Family From Lead In Your Home* before starting any work.
 - Either have the resident sign an acknowledgment form after receiving the pamphlet or send the resident a copy of the pamphlet via certified mail.
 - Keep copies of the residents' confirmation of receipt of the lead pamphlet or certificate of mailing for three years as documentation of your compliance with the regulations.
- Forms for confirmation of receipt of the lead pamphlet are included in the *Lead Pre-Renovation Education* handbook in Appendix 4 .
- Copies of both the *Protect Your Family From Lead In Your Home* and the *Lead Pre-Renovation Education Rule* handbook are included in Appendices 3 and 4, respectively. See the handout: *Resources for additional information* that accompanies the exercise later in this lesson for a list of where you can obtain these documents.
- Some states and local governments may have additional requirements for working on homes with lead-based paint. You can periodically check with the National Conference of State Legislatures (NCSL) for updates to state laws affecting lead-based paint for all states. The 1999 compilation is located at:
<http://www.ncsl.org/programs/ESNR/pblaw99.htm>.

Talking About Your Skills

◆ Why are you using lead-safe work practices?

- Keep the house safe
- Protect health of children and pregnant women
- Good professionalism

◆ Why are you qualified to conduct these activities?

- Completed this course
- Use lead-safe tools and supplies
- Experience with lead-safe work practices

02/23/2001



2-4

- In addition to any generic communication you have with residents during a renovation, remodeling, or rehabilitation job, they must be informed that your work has the potential to create lead dust. The EPA pamphlet *The Lead-Based Paint Pre-Renovation Rule* provides good pointers for talking to clients. The following topics should be discussed with the homeowner prior to beginning any renovation or remodeling job that has a potential to create lead dust:

Why are lead safe work practices a good idea?

- Incorporating lead safe work practices into your renovation, remodeling, and rehabilitation activities will:
 - Protect children's and workers' health
 - Keep the house safe from increased levels of lead dust
 - Is an example of good professionalism
- Module 1 presented more detailed information on these topics. Also, you can refer to the *Lead Paint Safety Field Guide* in Appendix 1 or to EPA pamphlet *Protect Your Family From Lead in Your Home* in Appendix 3 for additional information.

Discussing the Work Plan

◆ Discussing the work plan with residents

- Coordinate with program administrators and supervisors
- What lead safe work practices are planned?
- How will this work affect the residents' use of the house?
- How will you protect the residents' possessions from lead dust contamination?
- What activities will you expect the residents to perform before you begin your work?

02/23/2001



2-5

Discussing the work plan with residents

- In addition to discussing the hazards associated with lead-based paint and lead dust, you or your supervisor should review your plan for lead-safe work practices with the residents. This includes:
 - Describing how you will protect residents' possessions from further lead dust contamination
 - Identifying the activities you expect the residents to perform before you begin your work
- It is much easier to prevent possible problems during set-up than to do extra cleaning afterward. You may want to ask resident(s) to move some items before you begin your work. These include moving any furniture and fixtures out of the work area and storing them away from any work that may create dust. Seal over remaining items with polyethylene protective sheeting where possible. Moving items such as drapes, area rugs, and plants will reduce the potential for contaminating them with lead dust. If the paint in the work area is already deteriorated, you may suggest that the residents clean these items prior to moving them to other areas of the house to minimize the amount of lead dust that is distributed to other areas of the house. If the residents move and clean these items before the renovation work begins, you will not have to worry about being responsible for damaged or lost items.

Why Evaluate the Job for Lead?

- ◆ Reduce your potential liability from lead dust
- ◆ Incorporate lead activities into your work schedule
- ◆ Use lead-safe work practices
- ◆ Have the right materials and equipment
- ◆ Include the cost of lead-safe work practices
- ◆ Discuss occupant protection with residents
- ◆ OSHA regulations require employers to determine if employees will be exposed

02/23/2001



2-6

Why Evaluate Your Job

- There are a number of reasons why you should determine if your job will create lead dust prior to starting to work. These include:
 - Ensuring your activities will not create additional hazards or potential liabilities from lead dust.
 - Including lead dust control activities in your work schedule.
 - Using appropriate lead safe work practices.
 - Having materials and equipment on hand to safely manage lead dust, minimize the amount of dust created, and reduce the potential for spreading dust to other parts of the dwelling or surrounding area.
 - Accurately estimating the costs of the additional time, labor, and supplies needed to perform lead-safe work practices.
 - Making sure that this is a job you want to go into.
 - Developing a list of issues and preparing to discuss them with owners and occupants.
- It is a good idea to discuss lead-based paint, lead dust, and occupant protection with the residents before beginning the work. This allows you to sell this service to the residents and positively distinguish yourself from the competition.
- See the Field Guide pp. 11, 75, and 76.

Evaluating the Property

◆ Was the residential building constructed before 1978?

- If yes, take proper action and use lead-safe work practices
- If no, you do not have to worry about lead dust.

◆ Has the paint been tested for lead?

- If yes, collect documentation of what and where

02/23/2001



2-7

Was the property constructed prior to 1978?

- Many buildings constructed before 1978, especially those constructed prior to 1960, contain some lead-based paint. Unless otherwise documented, you should always assume that painted surfaces from pre-1978 houses include lead-based paint and that all dust generated from these surfaces may contain lead. Although the amount of lead-based paint found in homes varies, older dwellings typically contain higher concentrations of lead paint.
- **What is the age of the property?** If the property was constructed after 1978, you do not need to worry about performing lead safe work practices. The resident should be your first source for this information. They can get information on the age of the property from tax records or property deeds.
- **Has any prior renovation work been done?** If all of your work will be conducted in a dwelling constructed or renovated after 1978, you do not need to utilize lead-safe work practices, even if the rest of the property was built earlier. You should ask the owner for this information. If the owner does not know if or when renovation work was conducted, and the property was constructed prior to 1978, you should assume all paint surfaces contain lead-based paint.
- **Has a lead evaluation been conducted (for federally funded properties)?** Lead evaluations cover a range of activities that test for lead-based paint. If the owner has documentation that an EPA or state certified inspector or risk assessor performed a lead evaluation and found that no lead-based paint is present in the work area, you do not have to utilize lead safe work practices, regardless of the age of the property.

Evaluating the Work

◆ Will this job:

- Disturb painted surfaces?
- Otherwise create or disturb lead dust?

◆ If yes, take proper precautions:

- Pre-cleaning
- Set-up
- Work practices
- Clean up
- Clearance

◆ Will this job create high levels of dust?



U.S. Department of Housing
and Urban Development

02/23/2001

2-8

Will the work disturb painted surfaces, or create / disturb dust that may contain lead?

- All renovation, remodeling, and rehabilitation activities that disturb painted areas, including scraping paint, removing siding, replacing windows, will create some dust. Additionally, some areas, such as window troughs and loose areas near a building's foundation, typically accumulate dust and paint chips. You must consider these factors when approaching the job and develop an appropriate plan to deal with the potential lead dust. If your work will **NOT** disturb **ANY** painted surfaces or areas where lead dust can accumulate, you do not have to use lead-safe work practices.

What precautions are needed?

- The amount of dust created is directly related to the size of the work area, condition of the structure, and tools, materials, and dust control methods used. Later modules will present descriptions of the necessary precautions you should take while setting up the work areas, performing renovation, remodeling, or rehabilitation activities, and cleaning up.

If the job will disturb paint surfaces, will it create high dust that will cause you to take extra precautions?

- Work, such as demolition, or removing old paneling, siding, windows, or wall-to-wall carpeting, can create high dust levels. Additionally, surfaces with deteriorated or chipped paint are more likely to generate high levels of dust than intact surfaces. The level of dust a job will create directly affects other parts of your job, including the materials and equipment required, precautions taken during set up, and the control methods used.

Scheduling Work

◆ How will I schedule lead-safe work practices?

- Minimize hassle to residents
- Limit the size of the work area
- Minimize labor costs

◆ Take high dust jobs into account

02/23/2001



2-9

How will I schedule the lead safe work practices?

- When scheduling lead safe work practices, you should keep three goals in mind:
 - Minimize the hassle to the residents
 - Limit the size of the work area
 - Minimize extra labor costs
- In most cases, it is preferable to complete lead hazard control activities before beginning other renovation, remodeling, or rehabilitation activities. This will minimize the possibility of distributing lead dust outside of the work area. This may also allow most of your work to be done using traditional methods - without the precautions necessary when working with lead-based paint - thereby simplifying the coordination of other project-related activities. It would also minimize the hassle to the residents by reducing the areas of the house they should not enter because lead dust activities are taking place.
- For large projects, it may make more sense to conduct lead safe practices at the beginning of each phase of the project. For example, if you are renovating all of the bathrooms in a house, you may work in one bathroom at a time. In this case, it makes sense to perform lead-safe work practices at the beginning of each individual renovation activity as opposed to at the beginning of the entire job.

How Will Lead Affect the Job?

◆ How much extra time will the lead-safe work practices take?

- Talking with client
- Set-up
- Work
- Clean up

◆ What elements of the job can increase costs?

- Labor
- Supplies (see checklist in Module 4)

02/23/2001



U.S. Department of Housing
and Urban Development

2-10

How will the lead activities affect my job?

How much extra time will the lead-safe work practices take?

- This question only applies to the portion of the renovation, remodeling, or rehabilitation job dealing with lead-safe work practices. These activities will affect both worker and resident access to areas of the house where the work is taking place. The length of time the lead-safe practices requires could significantly affect the scheduling of other activities throughout the house. It is important to estimate the extra time associated with each phase of the lead-safe work practices when you are planning the project and developing cost estimates. Talking with the client and educating the client about lead-safe practices will also take up time.

What are the extra costs?

- The cost of lead-safe work practices and lead dust control techniques will vary depending on the project's size, scope, and scheduling. You should consider the following factors when developing a cost estimate:
 - Extra labor costs associated with performing the activities
 - Extra supplies needed
- To ensure you have the necessary materials on hand at the beginning of a project, it is helpful to review the checklist of supplies and materials listed on the back of the worksheet in Module 4. This list includes supplies that will typically be used on all jobs as well as specialized materials and supplies that may be required only under unique circumstances. All of the materials and tools in this checklist will be discussed in later modules.

Module 3

Setting Up Your Workspace to Contain Lead Dust

02/23/2001



3-1

56

02/23/2001

1

Module 3 Overview

◆ What is containment?

◆ High Dust Activities

- Hand scraping large areas
- Demolition

02/23/2001



3-2

Upon completion of this module you will be able to:

- Perform set-up techniques to contain lead dust and allow for easier cleanup at the end of the day and at the completion of the job.
- Identify appropriate set-up techniques for high dust jobs that may require additional containment.

What is a high dust job or activity?

- A working definition of a **high dust job** is one with activities that creates dust and debris that will spread beyond five feet from the area that you are working on. Conversely, a **low dust job** is one in which dust and debris will not spread beyond five feet from the work area.
- In general, jobs that involve only a small work area create less dust than jobs that involve a larger work area. However, in addition to the size of the job, the work practices (e.g., sanding), and equipment (e.g., power sander) used will affect how much dust is created. So, for example, using a power sander without a HEPA filter vacuum attachment on a two square foot area could be considered a high dust job. Using power tools equipped with HEPA filtered vacuum attachments will create less dust than using power tools without these attachments.
- Examples of high dust activities include:
 - Hand scraping large areas - interior and exterior
 - Demolishing painted surfaces
 - Using circular or reciprocating saw*
 - Removing dry residue and paint after using chemical strippers*

* Allowed by HUD Rule **only** if done with lead safe work practices

What Is Containment?

- ◆ **Keeping lead-contaminated dust in the work area**
- ◆ **Benefits of containment**
 - Protects residents and workers
 - Easier clean-up at the end of the job
 - More likely to pass clearance
- ◆ **Not required for working on areas below de minimis levels**

02/23/2001



3-3

What is containment?

- **For purposes of this training, “containment”** is anything that stops lead-contaminated dust from spreading beyond the work area to non-work areas.
- In general, there are many degrees of containment, ranging from simple plastic sheeting on the floor surrounding a small work area to a fully sealed dust room (discussed later in this module). Some types of containment are more effective than other types. A reusable drop cloth is not effective because it can trap and hold dust and paint chips, and can transport lead-contaminated dust from one job site to another. It is not an effective form of containment for working in homes with lead-based paint.

Benefits of containment

- **Reduces the risk to you and residents.** Following the work area set-up suggestions of this module will protect you, your co-workers, and residents from the negative health effects of lead while remodeling, renovating, or rehabilitation. Reduced risk to you and co-workers is also dependent upon wearing proper personal protection equipment.
- **Easier clean-up.** The pre-work set-up process is essential to keeping lead contaminated dust within the work area where it can be easily cleaned. Proper containment of the work area helps to limit the areas you need to clean up after the job is complete. This saves time and money for cleanup.

De Minimis Levels

The HUD de minimis levels are:

- 20 square feet on exterior surfaces
- 2 square feet in any one interior room or space
- 10 percent of the total surface area on an interior or exterior type of component with a small surface area

Current Interior Set-Up Practices Spread Lead-Contaminated Dust

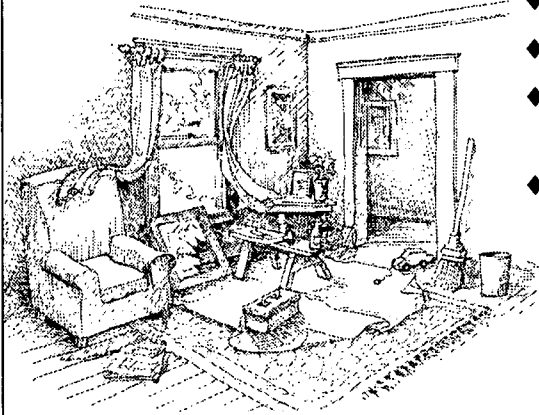

02/23/2001

- ◆ Reusable drop cloth
- ◆ Furniture in the room
- ◆ Open doors and windows
- ◆ Broom or shop vacuum

Do not use on jobs where lead is present!



U.S. Department of Housing and Urban Development

3-4

Current practice for interior set-up typically involves

- **A reusable drop cloth** is an improvement over not using any drop cloth, but it can carry dust from one job site to other job sites, and contaminate vehicles and storage areas. Some of the dust captured by a drop cloth falls to the floor when folding the cloth to carry away. However, some of the dust stays with the drop cloth. When it is used again it may contaminate the new (clean) job site with lead-contaminated dust.
- **Allowing furniture to remain in the work area** while the work is being performed. Lead-contaminated dust may fall and remain on these furnishings after the job is completed. Residents could easily come into contact with the lead-contaminated dust on the furnishings and get poisoned.
- **Allowing residents access to work area** while the work is underway. The residents are then exposed to the lead-contaminated dust and can track the dust to other parts of the building where it could linger. Again, residents could easily be exposed to the lead-contaminated dust on the furnishings and get poisoned.
- **Open windows and doors** allows lead dust to float into other parts of the building or over onto neighboring property.
- **Brooms and shop vacuums are typically used to clean-up.** Both clean-up methods capture some dust, but shop vacuums especially can put more dust into the air than they clean up if the filters are dirty or inadequate. Vigorous sweeping may also put a lot of dust into the air. To be effective, containment must be practiced even when cleaning up after the job.

Overview of Interior Set-Up Steps

- ◆ **Step 1: Limit access**
- ◆ **Step 2: Cover belongings that cannot be moved out**
- ◆ **Step 3: Cover floors**
- ◆ **Step 4: Close windows, doors, and HVAC system**
- ◆ **Special consideration for high dust jobs**
- ◆ **Not needed for jobs below HUD's de minimis levels of areas to be disturbed**

02/23/2001



3-5

Overview of interior set-up steps

- Details for these steps are on the following several pages. These four steps will help contain lead dust to the work area for interior jobs.
- See page 13 in the *Lead Paint Safety Field Guide* for additional information. Appendix 1 contains a copy of the text from the *Lead Paint Safety Field Guide*.

The de minimis levels are:

- 20 square feet on exterior surfaces
- 2 square feet in any one interior room or space
- 10 percent of the total surface area on an interior or exterior type of component with a small surface area

Job Set-Up Toolkit

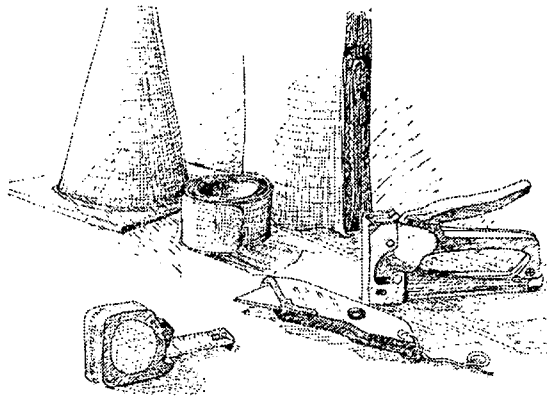

02/23/2001

U.S. Department of Housing
and Urban Development

3-6

Typical items for work area set-up to contain lead-contaminated dust:

Barriers, such as:

- Rope or other barrier
- Tape (bright color preferable)
- Saw horses
- Orange cones or other similar marker

Coverings for Unmovable Furniture, Fixtures, Plants or Out door Play areas:

- Duct tape, painters tape, or masking tape
- Stapler
- Heavy duty plastic sheeting, such as 4-6 mil plastic sheeting
- Utility knife or scissors
- Disposable mesh materials such as burlap, cheesecloth, or landscaping mesh

Other Set-Up Containment Items:

- Tack pad (sticky pad for walking on to remove dust from soles of shoes)
- Small disposable towels or wipes
- Misting bottle

Worker Protection (Required above the PEL):

- Coveralls, gloves (leather, cloth, plastic or rubber as appropriate), goggles
- Disposable shoe covers
- Appropriate respiratory protection
- Painters' hats

Interior Set-Up

Step 1: Limit Access

◆ Instruct residents to stay away from work area

◆ Do not allow young children (under 6 years) or pets near work area

◆ Place a barrier or tape across entrances

◆ Do not allow eating, drinking, or smoking in the work area

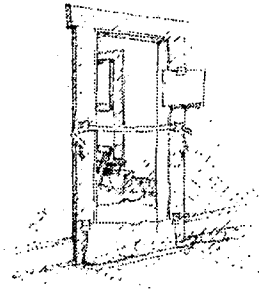

02/23/2001

3-7

Restrict access to the work area and ask residents to stay away while work is underway

- Restricting access to the work area will avoid unnecessary exposure of residents, especially children, to lead dust and minimize its spread to non work-areas.
- Tell the residents to stay away from the area as much as possible. Residents and pets coming and going can easily track lead-contaminated dust throughout the home and into areas that are not being worked on and therefore to areas that are unlikely to be cleaned up promptly.
- This is especially true for small children under six years old. Be sure to explain to residents that this is for their own protection and that small children are most at risk of health problems from exposure to lead.
- You may need to provide an indication of how long you will be working in a particular area so that residents can plan ahead to obtain items that they may need before you begin working.

Place a barrier across entrances

- A physical barrier, such as a cone or masking tape, should be placed across doorways to remind residents to stay away, especially in buildings where more than one family lives. The barrier serves as a reminder to residents that they should not enter the work area, and also signals that the area has not yet been cleaned up.

Do not allow eating, drinking or smoking in the work area

- This is primarily a protection for workers, but is also important if residents are living in or near the work area. Post signs that prohibit eating, drinking, or smoking in the work area. Dust in the air can land on food or be breathed when smoking. If food is set on an unwashed surface, it can easily pick up lead-contaminated dust, which is swallowed when eating the food.

Interior Set-Up Step 2: Cover Belongings

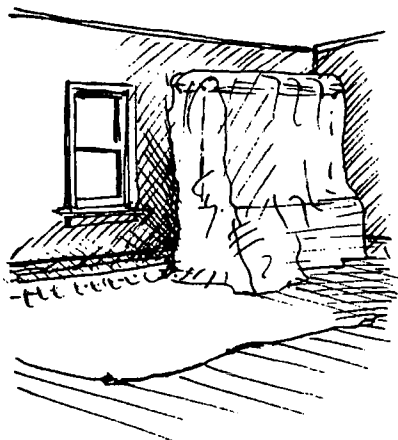

02/23/2001

◆ Cover furniture and objects in protective sheeting

- Furniture
- Carpet
- Lamps, pictures, and other fixtures



U.S. Department of Housing
and Urban Development

3-8

Cover furniture and other objects in the room with protective sheeting

- Cover all objects that were not removed from the room in protective sheeting. Completely cover all non-movable furniture, carpets, and other personal items with protective sheeting. Secure the protective sheeting to the floor with tape so that no dust can get onto the covered items.
- Heavy duty protective sheeting such as thick heavy duty plastic is commonly used in many rehabilitation jobs. Protective sheeting can be bought at many hardware stores.
- If it is a high-dust job, remove the furniture from the work area.

Interior Set-Up Step 3: Cover Floors

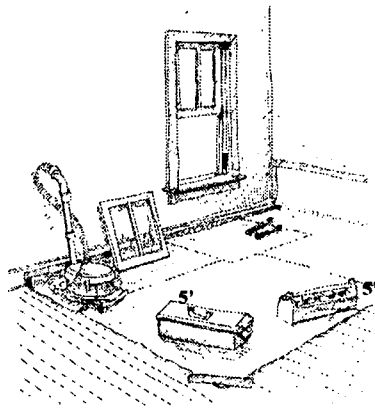

- ◆ **Cover floors with protective sheeting**
 - At least five feet on all sides of work area
 - 2nd smaller layer if using chemical strippers
 - Place a tack pad at edge of protective sheeting, lay protective sheeting on frequently used walking paths to outdoors and bathrooms



02/23/2001

3-9

Cover Floors

- Use protective sheeting to cover the floor. The protective sheeting should extend at least five feet to the left, right and front--and in some cases to the back--of the work area. It should be tightly secured to baseboard or flooring using duct tape, painters tape, or masking tape. The corner edge of the protective sheeting should be reinforced using duct tape or a staple.
- Use of a catch bag will assist in keeping dust and debris off of the floor and can increase efficiency of cleanup.
- A second smaller layer of protective sheeting should be used with chemical strippers. This second layer should be taped to the top of the first layer. Place the second layer immediately below the work area. This layer will capture any waste and aid in cleaning up.
- Tools that are used frequently should be left within the work area throughout the job to avoid tracking dust to non-covered areas.
- Consider covering shoes with removable booties, wiping off the tops and soles of shoes with a damp paper towel each time you step off the sheeting, or using a "tack pad" that removes dust from the soles of shoes. Immediately place used paper towels in a covered garbage bin. A tack pad can be found at most hardware stores or bought through a supply catalog; it is a sticky pad that you walk on to remove dust from the soles of your shoes. The tack pad can be taped to an outer corner of the sheeting.

Note: If tack pads are not readily available to you, contact the National Lead Assessment and Abatement Council (NLAAC) at (800) 590-NLAC for information on where to get them.

Interior Set-Up

Step 4: Close Windows, Doors, HVAC

- ◆ **Close and seal windows and doors**
- ◆ **Close and seal HVAC vents**

02/23/2001



3-10

Close and cover windows and doors

- Close and seal windows (if no work is being done on the window) and doors, including closet and cabinet doors in the work area.

Close and seal HVAC vents

- Heating ventilating and air conditioning (HVAC) systems distribute air throughout the building and thus can allow dust to move to other rooms. Close and cover the HVAC vents in the work area to prevent air from blowing the dust out of the contained work area and to prevent dust from getting into the HVAC system.

Special Considerations for Interior High Dust Jobs

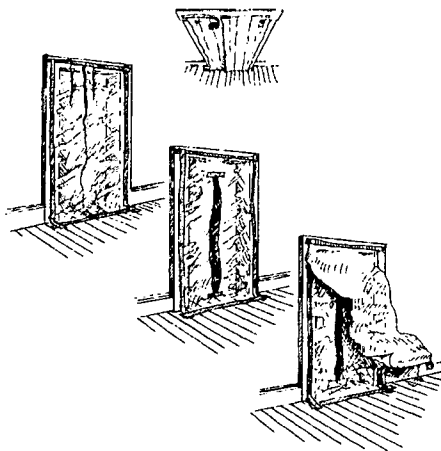

02/23/2001



3-11

- ◆ Remove furniture, fixtures and belongings from work area
- ◆ Cover door openings with 2 layers of protective sheeting to form an “airlock”
- ◆ Close and cover HVAC vents

Remove throw rugs, draperies, and furniture from the work area when completing a high dust job

- Before starting work, request that the homeowner remove furniture and fixtures from the room. This will prevent lead-contaminated dust from getting into these items.

Cover door openings with 2 layers of protective sheeting

- Covering the door with this two-layer system will contain the dust within the work area. Follow the steps below:
 - 1) Cut first plastic sheeting layer slightly wider and longer (three inches) than door frame.
 - 2) Make small “s” fold at the top of sheeting and tape to top of door frame. Make a similar “s” fold at the bottom of the sheeting and tape to flooring. This will ensure that the plastic is not taut. Staple top corners for reinforcement.
 - 3) For exiting and entering the room, cut a long vertical slit in middle of protective sheeting; leave six inches at top and bottom uncut. Reinforce the top and bottom of the slit with tape to prevent the plastic from tearing.
 - 4) Tape a second layer of protective sheeting to top of door frame. This layer is cut slightly shorter than door frame so that it will hang down flat against the first sheet of plastic.
 - 5) Tape and staple top corners of second layer to door frame and first layer. Leave hanging over first layer.
- See Page 46 in the *Lead Paint Safety Field Guide* for more information on how to put the two layer system in place.

Close and seal HVAC vents in the room

- Turn off the HVAC system for work area. The vents should then be closed and covered with cardboard and protective plastic sheeting. After the work is complete the vent covers should be removed and washed.

Special Considerations For Interior High Dust Jobs

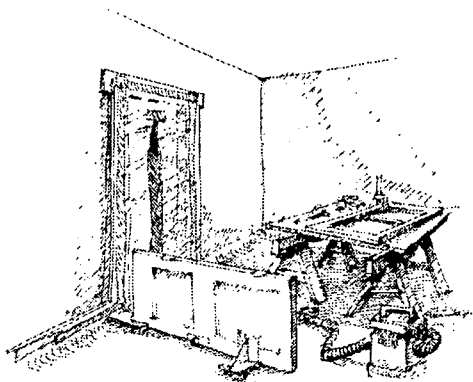

02/23/2001

- ◆ For work on removable objects that create lots of dust
- ◆ Select a room that can be easily closed off
 - Follow Steps 1 through 4 for interior set-up
 - Follow the procedures for high dust jobs
- ◆ Do the work off-site



U.S. Department of Housing
and Urban Development

3-12

Consider setting up a work room (“dust room”) for high dust-generating work on components that can be moved out of their original room and into the dust room

- A dust room prevents the spread of lead-contaminated paint and dust to non-work areas and also makes clean-up easier.
- Use this technique for high dust activities, for example, planing and scraping doors or window sashes where you are maintaining the original windows.
- Set up a dust room if work is being done on components in a room that residents must have access to, such as the kitchen. Rather than keeping the resident out of the kitchen, remove the components to the separate dust room and complete surface preparation there. After preparation is complete, the components can be returned to the kitchen.

Select a room that can be easily closed off from the rest of the home to use as a dust room, or work off-site

- A dust room can be any room that can be closed off. Residents should not have to enter this space for the duration of the job. For example, a spare bedroom or other unused room that residents do not need to access during the time that the work is being performed.
- The dust room should be close to the work area, if possible.
- Follow the four set-up steps for all work with minor modifications or additions: 1) limit access, 2) remove furnishings, 3) cover the floor, 4) seal windows, doors, and HVAC vents.
- Workers should wear protective clothing, NIOSH approved respirators (e.g., N100), and safety goggles.
- Plan your work so that necessary supplies and equipment are in the room to minimize the number of trips outside the room while work is being performed.
- See Page 14 in the *Lead Paint Safety Field Guide* for more information.

67

02/23/2001

Current Exterior Set-Up Practices Spread Lead-Contaminated Dust

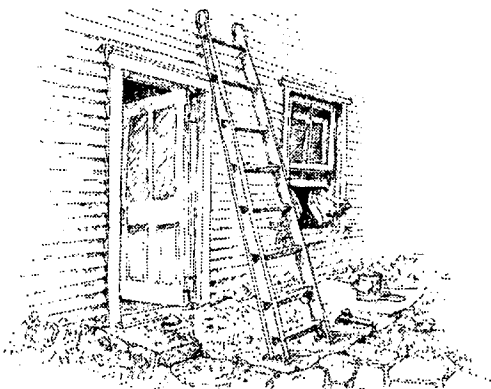

- ◆ Ground uncovered
- ◆ Reusable drop cloth
- ◆ Paint chips
- ◆ No barriers
- ◆ Windows and doors open

**These practices can
poison children!**



02/23/2001

3-13

Current practices for exterior set-up

- **Leaving the ground uncovered** allows lead contaminated dust to get into the dirt, washed into storm drains, and into nearby play areas.
- **Covering with reusable drop cloth.** Similar to the problems associated with using a reusable drop cloth for interior jobs, a reusable drop cloth for exterior jobs can carry dust from one job site to other job sites. Some of the dust captured by a drop cloth falls to the floor when folding it to carry away. However, some of the dust stays with the drop cloth to the next work site, thus potentially spreading lead-contaminated dust to a new work site.
- **Small paint chips** and piles of dirt are often overlooked. This poses a considerable hazard to small children.
- **Residents and passers-by usually have unlimited access to area.** Similar to interior work, residents and passers-by may come into contact with lead-contaminated dust and breathe or swallow it.
- **Windows and doors are left open** and may allow lead contaminated dust to enter the house.

Overview of Exterior Set-up Steps

- ◆ **Step 1: Establish work area**
- ◆ **Step 2: Close windows and doors and keep closed**
- ◆ **Not needed for jobs below HUD's de minimis levels of areas to be disturbed**

02/23/2001



3-14

Two steps for exterior set-up to contain lead dust

- Details for these steps are on the following two pages. These two steps will help contain lead dust to the work area for exterior jobs.
- See page 22 in the *Lead Paint Safety Field Guide* for more information.

The de minimis levels are:

- 20 square feet on exterior surfaces
- 2 square feet in any one interior room or space
- 10 percent of the total surface area on an interior or exterior type of component with a small surface area

Exterior Set-Up

Step 1: Establish Work Area

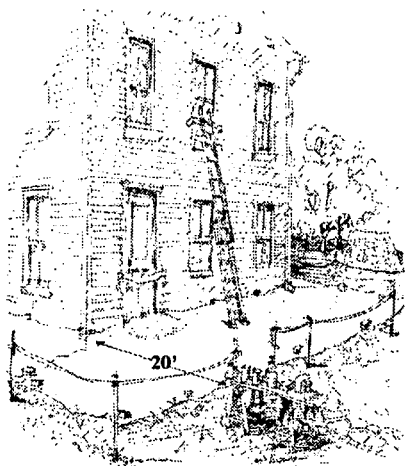

02/23/2001

- ◆ **Cover the ground with protective sheeting**
 - If space permits, extend at least 10 feet from work area
 - Cover nearby vegetable gardens and children's play areas
- ◆ **Limit work area access**
 - Establish a 20 foot perimeter around work area if space permits



U.S. Department of Housing
and Urban Development

3-15

- **Cover the ground with protective sheeting** If space permits, lay protective sheeting on the ground below the work area to at least 10 feet from the house. This creates a visible work area and helps remind residents and passers-by that they should not enter the work area unless they have a compelling need. Note: Black plastic can kill plants.
- **An option for covering grass, shrubs, and gardens is a disposable mesh material** such as landscape fabric or burlap. Landscape fabric is an inexpensive plastic mesh that is often used by landscapers. It can be found in many plant nurseries or hardware stores. This covering will protect the soil and plants from lead contamination. Remember children often play in the dirt and may put their hands in their mouth while playing. Any dirt on their hands will go into their mouths and may be swallowed.
- **Remove toys and other items from work area** and cover all play areas including sandboxes.
- **Staple or tape the protective sheeting to the wall** of the building, or use a 2x4 to hold the material next to the wall. Use heavy objects (e.g., rocks) to weight the other edges of the protective sheeting to the ground so that it won't blow in the wind.
- **When using ladders on plastic sheeting** consider placing a sturdy piece of plywood on the plastic and then setting the ladder on the plywood. This will prevent the ladder from puncturing the plastic and also will provide a stable surface for the ladder.

Limit work area access

- Limit access to work area by placing orange cones, saw horses, or tape around a 20 foot perimeter of the work area. This will help to discourage residents and passersby from entering the work area.

70

Exterior Set-Up Step 2: Close Windows & Doors

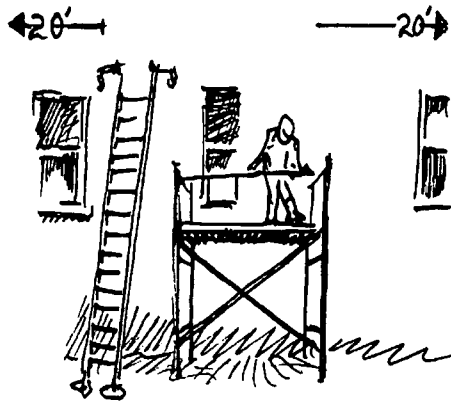

- ◆ Close nearby doors and windows within 20 feet of the work area

02/23/2001

U.S. Department of Housing
and Urban Development

3-16

Close and cover windows and doors

- All windows and doors within 20 feet work area should be closed to prevent dust from entering the home. Consider requesting that the neighbors also close their windows and doors.

71

BEST COPY AVAILABLE

MODULE 3 EXERCISE

Objective: Review set-up methods to contain lead dust and allow for easier clean-up.

Length: 30 minutes, including discussion of answers

Directions: In groups of three or four take 20 minutes to review the three illustrations below and:

- Identify three set-up methods that encourage the *spread* of lead-contaminated dust and debris beyond the work area;
- Identify three techniques that could be used to *reduce* the spread of lead-contaminated dust and debris to non-work areas;
- Assign one person to report your group's answers to the rest of the class.

Illustration 1

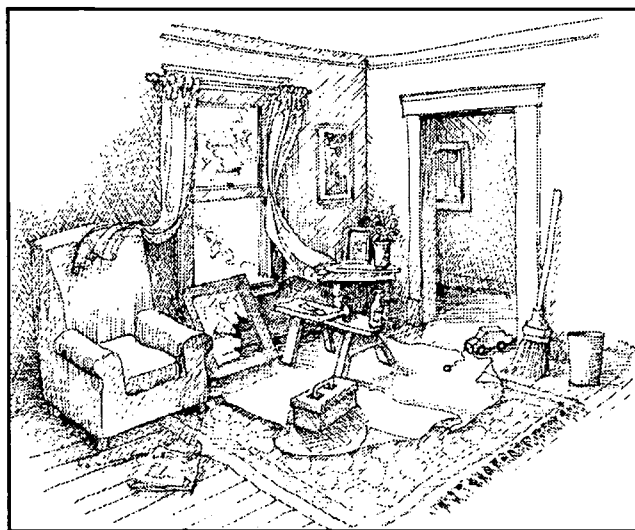

Increase the Spread of Dust and Debris

Reduce the Spread of Dust and Debris

Illustration 1

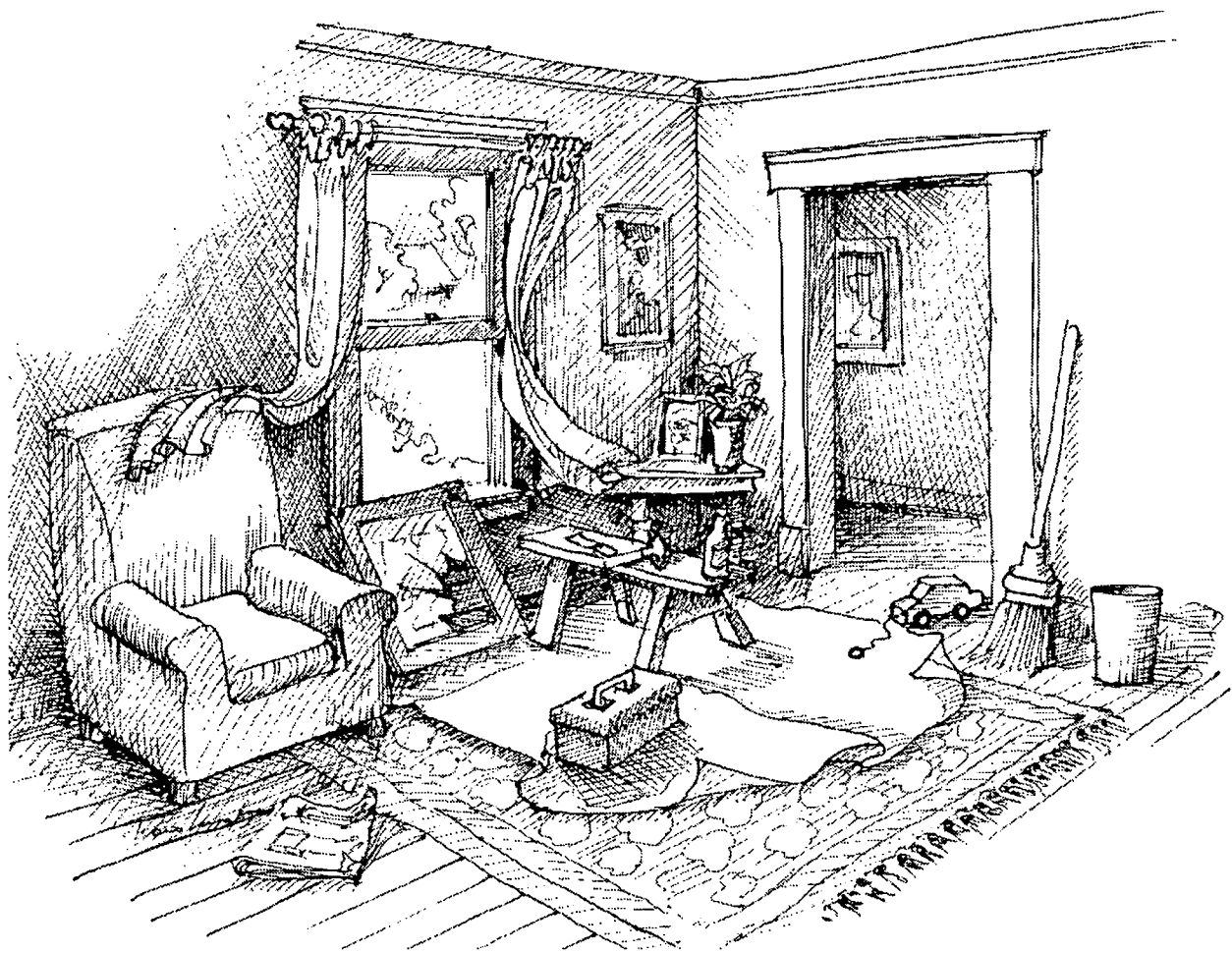

MODULE 3 EXERCISE

Illustration 2

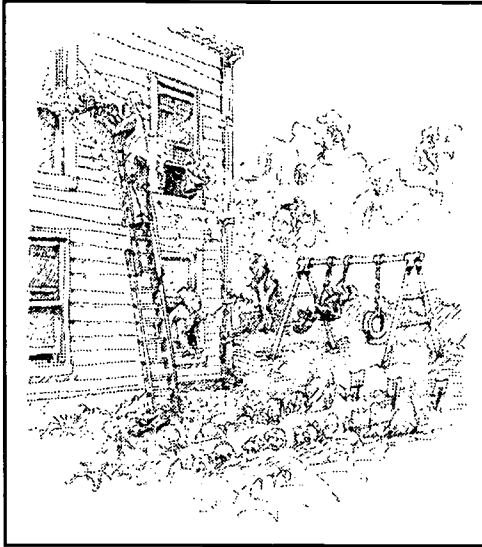

Increase the Spread of Dust and Debris

Reduce the Spread of Dust and Debris

Illustration 3



Increase the Spread of Dust and Debris

Decrease the Spread of Dust and Debris

Illustration 2



Illustration 3

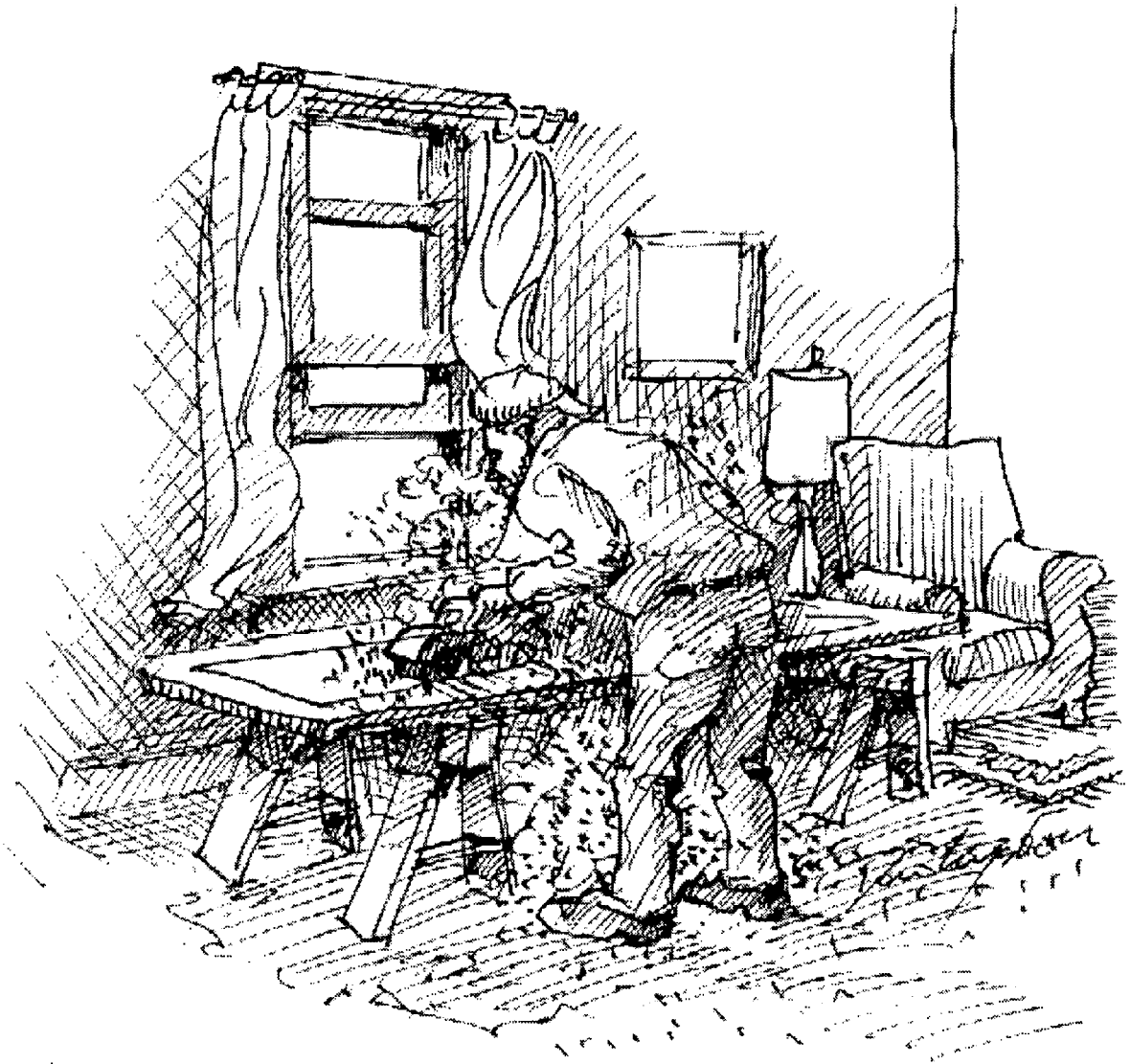

Module 4

Safe Work Practices

02/23/2001



4-1

Module 4 Overview

- ◆ Prohibited Practices
- ◆ Safe work practices to perform work
- ◆ Tools and supplies you may need
- ◆ Basic steps to protect yourself
- ◆ Control the spread of dust
- ◆ Exercise
- ◆ Summary

02/23/2001



4-2

Role of safe work practices

- In addition to proper set-up at the start of a job and cleanup at the end of the job, the third key strategy to minimize the spread of dust is using safe work practices.

Upon completion of this module, you will know

- What work practices are prohibited because they create dangerous amounts of dust and paint chips.
- What safe work practices to use to reduce and control dust and paint chips.
- What tools you will need.
- How to apply safe work practices to common renovation, remodeling, and rehabilitation jobs.

Typical Lead Dust Creation

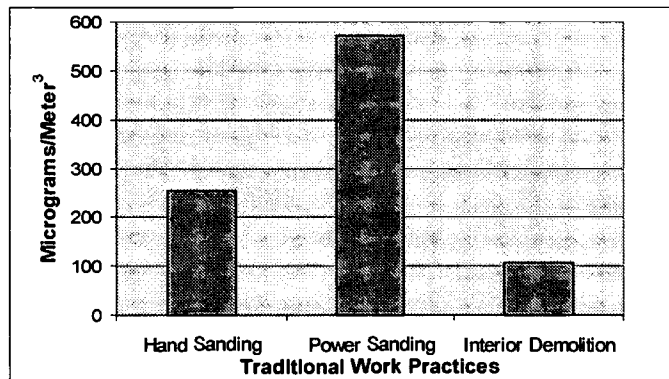

02/23/2001



4-3

Traditional work practices may create large amounts of dust

- This chart shows amounts of airborne lead dust created by three common construction practices: hand sanding, power sanding, and interior demolition. Note all airborne dust eventually becomes settled dust.
- The amount of lead dust for each practice is significantly higher than the level where worker protection, such as respirators and protective clothing, is required by OSHA. This airborne dust is hard to control.
- By using safe work practices, you can control and significantly reduce the amount of dust created on the job. Controlling lead dust at the source of generation is important because dust generated into the air will eventually become settled dust on the ground. Later in this chapter, you will learn safe work practices that can replace these prohibited work practices.
- The data used in the chart above are from *Lead Exposure Associated with Renovation and Remodeling Activities: Summary Report*, Prepared by Battelle for the U.S. Environmental Protection Agency, May 1997, EPA 747-R-96-005.
- Conduct initial exposure assessment as required by OSHA lead construction standard. Information on conducting initial exposure assessments can be found in Appendix 6 or on the world-wide-web at www.osha.gov.

Practices Prohibited by HUD in Federally Owned and Assisted Housing

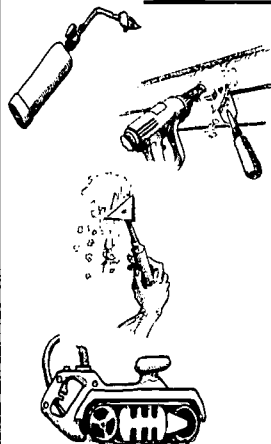

- ◆ Open flame burning or torching
- ◆ Machine sanding, grinding, abrasive blasting, or sandblasting without HEPA exhaust
- ◆ Heat gun above 1,100 degrees Fahrenheit
- ◆ Extensive dry scraping and dry sanding
- ◆ Paint stripping in a poorly ventilated space using a volatile stripper that is a hazardous substance

02/23/2001

U.S. Department of Housing
and Urban Development

4-4

Do not use these traditional work practices:

- A key to minimizing the spread of dust and paint chips is to not use certain traditional work practices known to create large amounts of dust and debris.
 - **Open flame burning or torching of paint and using a heat gun above 1,100° F** create fumes that are dangerous for workers to breathe. Small lead particles created by burning and heating also settle on surrounding surfaces and are very hard to clean up.
 - **Machine sanding, grinding, abrasive blasting, or sandblasting without HEPA exhaust** even on a small surface, creates a large amount of leaded dust that floats in the air and then settles on surfaces inside and outside the work area.
 - **Heat gun above 1,100 degrees Fahrenheit** may generate lead fumes which are an inhalation hazard.
 - **Extensive dry hand sanding and hand scraping** can also create large amounts of dust and paint chips.
 - **Paint stripping** is not a common work practice during most types of renovation and remodeling activities.
- See pages 9-10 in the *Lead Paint Safety Field Guide* for more information about these practices.

Safe Work Practice Alternatives to HUD's Prohibited Practices

Prohibited	Safe
<input checked="" type="checkbox"/> Open flame burning or torching	✓ Wet scraping and sanding, chemical stripping, heat gun below 1,100 degrees F
<input checked="" type="checkbox"/> Heat gun on high (1,100+ degrees F)	✓ Heat gun below 1,100 degrees F
<input checked="" type="checkbox"/> Dry scraping and sanding	✓ Wet scraping and sanding
<input checked="" type="checkbox"/> Power sanding, grinding, abrasive blasting without attachment to HEPA vacuum	✓ Use of power tools with attachment to HEPA vacuum

02/23/2001



4-5

Alternative safe work practices for each prohibited practice

- For both large and small paint removal jobs, there are safe work practice alternatives.
- Some possible alternatives are listed on the slide.
- With experience, you will determine which safe work practices work best for different tasks.

Note: HEPA (high efficiency particulate air) vacuums have HEPA-rated filters that stop 99.97% of particles of 0.3 microns or larger.

Also keep in mind

- Chemical strippers can be dangerous and should be used with great caution. Some can cause burns. Methylene chloride is suspected to cause cancer. Types of strippers range from citrus-based (safer) to more dangerous caustic strippers. Use of chemical strippers may trigger additional training, notification, and record keeping requirements under the OSHA Hazard Communication Standard. Follow the manufacturer's directions when using any chemical stripper.
- If building components to be stripped can be removed, such as doors, consider having them stripped off-site at a paint stripping facility.
- Half-face negative-pressure respirators do not provide sufficient breathing protection when using methylene chloride strippers.
- See pages 9-10 in the *Lead Paint Safety Field Guide* for more information.

More Safe Work Practices

- ◆ Mist before drilling and cutting
(hand tools only)
- ◆ Score paint
- ◆ Minimize pounding and
hammering -- pry and pull instead
- ◆ Mist surroundings



02/23/2001

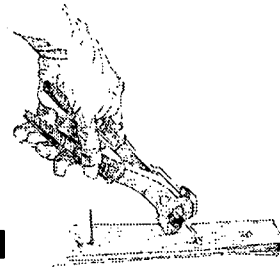
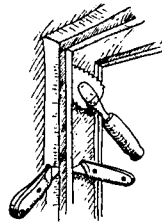

U.S. Department of Housing
and Urban Development

4-6

Additional safe work practices

- Mist before drilling and cutting to reduce dust creation and keep dust from becoming airborne and spreading beyond the work area.
- Scoring paint before separating components helps prevent paint from chipping when a paint seal is broken.
- Prying and pulling apart components and pulling nails instead of pounding create less dust and fewer paint chips. Vise grips may be useful when pulling nails.
- Frequent misting of surrounding surfaces with water helps keep dust and paint chips from becoming airborne when disturbed by work activity.
- When employing wet methods, employees must be extremely careful to avoid electrical shock and electrocution hazards.
- Using power tools on heavily misted surfaces can be dangerous. Tool blades can slip and water can cause electric shock. When misting, lightly mist the surface and use hand tools only. If power tools are to be used, they should be attached to a HEPA vacuum.
- Ground fault circuit interrupters (GFCIs) must be used when working around sources of electricity to prevent electric shock injuries. Use of water around live electrical outlets is prohibited.
- Consider use of foam (such as shaving cream) when cutting or drilling to reduce dust generation.
- HUD's Lead Safe Housing Rule contains an exemption for wet methods when working within one foot of an electrical outlet.

Benefits of Safe Work Practices

- ◆ **Protect your family by not bringing dust home with you**
- ◆ **Enhance reputation for knowledge and professionalism**
- ◆ **Reduce resident exposure to lead**
- ◆ **Simplify daily and final cleanup**
- ◆ **Help protect workers from inhaling dust**
- ◆ **Protect children**

02/23/2001



4-7

Advantages for contractors

- In addition to being safer for residents, safe work practices have advantages for contractors and workers.

By effectively using safe work practices, you can

- Foster your reputation as an informed and professional contractor who recognizes the risks of lead-based paint and takes steps to help ensure resident and worker safety.
- Gain a reputation for leaving the job site cleaner than when you arrived.
- Help your customers feel safe and reduce their anxiety about the risks of renovation, remodeling, and rehabilitation work.
- Have less dust and debris to clean up at the end of the job.
- Reduce risk of taking leaded dust home to your family.

Safe Work Practices Toolkit: Tools, Equipment, and Supplies

- ◆ Wet/dry sandpaper, sanding sponge (block)
- ◆ Mist bottle, pump sprayer
- ◆ Tape (painter's, duct, masking)
- ◆ Heavy duty plastic sheeting, such as 4-6 mil
- ◆ Chemical stripper
- ◆ Garbage bags and duct tape
- ◆ Utility knife
- ◆ Heat gun
- ◆ Vacuum with HEPA filter

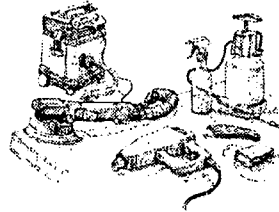

02/23/2001

4-8

Safe work practices toolkit tools, equipment, and supplies

- There are some basic low-cost tools that you will need for safe work practices. Most of these tools and supplies are widely available from suppliers and home improvement stores.
- These tools are used to help reduce dust and for cleaning while working to keep dust under control.
- You will need several basic supplies to protect floor and ground surfaces, and bag, wrap, and clean dust as work is performed. If dust and debris are contained in plastic right after they are created, there is less chance that they will be spread beyond the work site.
- More toolkit supplies are listed on the next three pages of this manual.
- See pages 75-76 Tool and Supply List in the *Lead Paint Safety Field Guide* for more information.

HEPA (high efficiency particulate air) filters are able to filter very small particles--to be considered a HEPA filter, it must be able to filter 99.97% of microscopic particles.

Safe Work Practices Toolkit: HEPA-Filtered Power Tools

◆ Large jobs may require special tools

- Power sanders, grinders, planers, shavers with HEPA filter vacuum attachment
- These tools increase productivity



02/23/2001

U.S. Department of Housing
and Urban Development

4-9

HEPA equipment for power tools

- Because wet methods are appropriate and practical only when using hand tools, adapters and HEPA vacuums are necessary for power tools.
- These tools use HEPA vacuums and adapters that help contain dust and debris as they are created. A shroud helps to contain the dust and paint chips as they are created. They are carried to a HEPA vacuum by a hose attached to the shroud. Use of these tools increases productivity.
- It may be possible to rent these tools, if you decide to not invest in them.
- Use tools in accordance with manufacturer's recommendations and lead safe work practices.

Power washing

- Power washing can be used if runoff is properly contained and disposed.

Set-up is still important

- Proper set-up and cleanup is still important because HEPA attachments do not eliminate the possibility that work will spread dust. Nonetheless, these attachments will reduce dust levels and thereby shorten cleaning time and lower costs.
- See pages 75-76 Tool and Supply List in the *Lead Paint Safety Field Guide* for more information.

Protect Yourself

◆ Workers should wear

- Painter's hat -- helps keep dust out of hair
- Disposable or washable coveralls
 - Can be reused if not ripped
 - Launder separately
- Disposable N-100-rated respirator (dusty jobs)
- Gloves (during certain tasks, *i.e. High Dust Jobs*)



◆ Wash face and hands frequently

- Helps to reduce hand-to-mouth ingestion of lead dust

◆ OSHA may require more protection



U.S. Department of Housing
and Urban Development

02/23/2001

4-10

Workers should protect themselves

- **Minimum steps** that workers can take to protect themselves include:
 - **Painter's hats** are an inexpensive way to keep dust and paint chips out of workers' hair. Painter's hats can be easily disposed of at the end of the day or job.
 - **Disposable coveralls** are a good way to keep dust off of workers clothes and reduce the chances for carrying dust to other areas of the residence as workers come and go. The coveralls can be removed when workers leave the work site and stored in a plastic bag overnight. To keep costs down, consider buying extra large size coveralls in bulk and sizing to fit workers with duct tape. Some coveralls have a hood to keep dust out of hair.
 - **Respiratory protection.** Workers should wear respiratory protection, such as an N100 disposable respirator, to prevent them from breathing leaded dust.
 - **Workers should wash** their hands and faces periodically to avoid ingesting leaded dust. It is especially important to wash well before eating, drinking or smoking and to not do any of these in the work site. Some of the dust that settles on the face around the mouth invariably finds its way into the mouth. Workers should also wash at the end of the day before getting in their car or going home. They can take leaded dust home to their families.
- OSHA rules require employers to take further steps to protect the health of workers on the job based on their exposure to lead. See slides on OSHA requirements.
- See page 17 in the *Lead Paint Safety Field Guide* for more information on worker protection.

Safe Work Practices Toolkit: Tools, Equipment, and Supplies

- ◆ Disposable hand towels
- ◆ Pre-moistened disposable wipes
- ◆ Painter's hats
- ◆ Gloves
- ◆ Coveralls
- ◆ Disposable booties
- ◆ N-100-rated disposable respirators where appropriate



02/23/2001

4-11

Safe work practices toolkit tools, supplies and equipment for personal protection

- Disposable hand towels (such as paper towels) and pre-moistened wipes have multiple uses on the job. They can be used to quickly clean surfaces and by workers to wipe dust before leaving the work site and washing before eating, smoking, or drinking.
- "N100" is a NIOSH rating for respirators. Respirators with an N100 (or HEPA) rating are approved for use when working on lead-based paint surfaces. OSHA requires different types of respirator rated for use around lead if exposures are high.
- All of the items on this list are readily available at hardware and home improvement stores. N100 disposable respirators cost approximately \$6-7.
- See pages 75-76 Tool and Supply List in the *Lead Paint Safety Field Guide* for more information.

Control the Spread of Dust

◆ When you leave the work area

- Remove booties
- HEPA vacuum or wipe shoes - use tack mat
- Remove coveralls or HEPA vacuum clothes

◆ At the end of the day, don't take lead home to your family on your clothes or in your car

- HEPA vacuum clothes, shoes
- Change your clothes and dispose or place in plastic bag to wash separately from household laundry
- Wash hands, face
- Shower as soon as you get home

02/23/2001



4-12

Precautions to take when leaving the work site

- When you leave the work site (the area covered by protective sheeting or the room), take precautions to prevent spreading dust and paint chips to other parts of the residence on your clothes and shoes.
- Every time you leave the work site, wipe or vacuum your shoes before you step off of the plastic sheeting. A large tack pad on the floor can help to clean the soles of your shoes. Remove booties if you are using them.
- At the end of the day, change your clothes and wash yourself to reduce the risk of contaminating your car and taking leaded dust home to your family.
- Before leaving the worksite-- remove any protective clothing, HEPA vacuum (no shop vacs) dust from non-protective clothing, and thoroughly wash your hands and face. Throw away disposable clothing or place clothing in a plastic bag to stop dust from getting on other clothes at home.
- At home-- as soon as you arrive at home, take a shower and be sure to thoroughly wash your hair, especially before playing with children. Wash work clothes separately from regular household laundry to stop lead particles from getting on your other clothes.

Cleaning During the Job

- ◆ **A clean work site reduces the spread of dust and paint chips**
- ◆ **Clean as you work**
 - HEPA vacuum horizontal surfaces
 - Remove debris frequently
 - Remove paint chips as they are created
 - As building components are removed, wrap and dispose of them promptly
- ◆ **Clean frequently (in stages, at least daily)**

02/23/2001



4-13

Clean the work site frequently

- Cleaning the work site frequently as the job progresses will reduce the spread of dust and paint chips. The cleaning need not be as thorough as the final cleanup. It should, however, keep debris, dust, and paint chips from piling up and spreading beyond the immediate work site.

Cleanup during the job includes

- **Removing debris frequently.** During demolition jobs, seal and dispose of construction debris as it is created.
- **Vacuuming horizontal surfaces frequently.** HEPA vacuum dust and paint chips that settle on surfaces, including protective sheeting. As workers come and go during the work day, this debris is easily spread. Periodic cleaning throughout the work day will help to minimize workers tracking dust. **DO NOT USE NON-HEPA FILTERED VACUUMS OR DRY SWEEPING FOR CLEANUP.**
- **Collect paint chips as they are created.** When removing paint, piles of paint chips can also spread outside the immediate work area as workers come and go from the work site. To keep paint chips from spreading beyond the work site, make sure that they are collected as they are created. Also, periodically HEPA vacuum or wet sweep and dispose of paint chips.
- **Wrapping and disposing of removed components.** When removing painted components such as windows, trim, and cabinets, wrap them in plastic sheeting and dispose of them in stages. This will prevent the spread of debris and keep residents, especially children, from coming into contact with leaded dust created by work.
- **How often should cleaning during the job take place?** The goal is to keep dust and debris under control, not to maintain a completely spotless site at all times. Every job is different, so clean when it makes sense to without hindering progress. Remove large amounts of dust, paint chips, and debris frequently, at least daily.

Exercise

◆ Objective - Exercise A

- Evaluate a scenario
- Plan Activities

◆ Objective - Exercise B

- Evaluate a scenario
- Identify potential activities that create dust
- Identify steps you can take to minimize dust, and
- Talk to clients about the potential lead dangers from the work

◆ Use checklist

02/23/2001



U.S. Department of Housing
and Urban Development

4-14

MODULE 4 EXERCISE 4A

Objective: Identify safe work practices for typical renovation, remodeling, and rehabilitation tasks.

Length: Total time: 25 minutes

Directions: Take 5 minutes to read the background and the jobs below. When you are finished, the instructor will ask you and the other students to contribute approaches to each of the jobs listed below. You may take notes on approaches under each description.

Background:

You have been asked to plan renovation work on a Victorian style home built around 1910. You are looking forward to doing a lead-safe, high quality job and getting a good reference. This represents at least three solid weeks of work for your workers. To be safe, you have advised the owners that you assume some layers of paint are lead-based paint. You reassure them that you will take steps to reduce the risk of creating a lead hazard.

The Jobs

How will you approach each of the following jobs in a lead safe way?

1. Remove worn green carpet from vestibule, first floor hallway, and staircase. The carpet is tacked to the floor and its edges are covered with quarter round at all of the walls. The carpet is being removed to expose hardwood flooring which is to be refinished.

2. Enlarge the door size opening in the wall between the living and dining rooms to make way for an enlarged passageway. There is trim at the base of the walls and trim at the top and sides of the opening. As much of the trim as possible should be saved to be reused on the enlarged opening. The new opening will be as tall as before but wider.

MODULE 4 EXERCISE 4B

Objectives: The objective of this exercise is fourfold:

- To evaluate a project's potential to create lead dust and plan your work to minimize the creation and dispersion of this dust.
- To familiarize yourself with the worksheets included in this module and use them to evaluate a potential scenario.
- To discuss ways to talk to clients about lead safe work practices and ensure they are informed about the dangers of lead dust.
- To ensure you understand your requirements related to disseminating information related to lead-based paint.

Length: Total Time: 35 minutes - 20 minutes working in groups and 15 minutes discussion

Directions: The following exercise presents a scenario that may be similar to situations routinely encountered by you or your company. In groups of three to five (depending on class size), take the next 20 minutes to read over the scenario and answer the questions on the next two pages. Before answering the questions, however, complete the attached worksheet. If you need to make assumptions in order to complete the questions or the worksheet, please be sure to write down your assumptions and include them in your worksheet and answers.

Background

New property owners have contracted with your company to perform major remodeling work throughout a house constructed in the 1950's. On the main floor, the work consists of remodeling the kitchen (existing dimensions are 12' x 15') and adding a new 15' x 15' sunroom off of the kitchen. This remodeling work includes tearing out existing cabinets, flooring, and a painted wall. Upstairs, the residents have asked you to renovate the half-bath by removing the existing linoleum flooring and sink (porcelain sink attached to the wall with plumbing beneath exposed) and then laying new floor tiles and installing a new sink and cabinet unit. To the best of the residents' knowledge, no major renovation, remodeling and rehabilitation work has been done on the house since it was constructed and the former residents never mentioned lead-based paint.

Although the house is currently vacant, the new owners are planning on moving into the house in the very near future. It is highly likely that they will move in before all of the renovation work has been completed. The new owners are a couple in their early thirties with two children under the age of six, and two pet cats that are kept indoors.

Addressing Lead-Based Paint Hazards During Renovation, Remodeling, and Rehabilitation in Federally Owned and Assisted Housing

MODULE 4 EXERCISE 4B

Complete the attached worksheet based on the information provided in the scenario. After completing the worksheet, answer the following questions. At the end of the exercise, you may be asked to share your answers with the class. Be prepared to explain your answers.

1. Was the property constructed prior to 1978 and do you have to utilize lead safe work practices?
2. Is this a high dust job? If yes, what work activities are likely to create high dust levels? What special precautions should you take to minimize the hazards associated with high levels of lead dust?
3. How would you schedule the work? When would you perform lead safe work practices in relation to the other renovation, remodeling, and rehabilitation work? Why?

MODULE 4 EXERCISE 4B

4. How did you develop your cost and labor estimates? Will any special tools or equipment be needed for this job?

The following questions pertain to talking to the residents.

5. What topics, related to lead dust and lead safe work practices, should you highlight when discussing the job with the residents? Where could you refer the residents if they ask for additional information?
6. After discussing the potential lead dust hazards and the associated lead safe work practices with the residents, they insist that these actions are not necessary because the house does not contain any lead-based paint. How do you respond?

WORKSHEET: EVALUATING THE JOB

1. Was the property constructed prior to 1978? or, If the work area is limited to an addition, was the addition constructed prior to 1978?

Yes _____ No _____

✓ If no, you are not required to perform lead safe work practices.

Yes _____ No _____

✓ Do you have documentation that the work area has been designed as lead-free by a certified inspector or risk assessor?

Yes _____ No _____

2. Will this work disturb painted surfaces or otherwise create or disturb dust that may contain lead?

✓ Is this a high dust job?
If yes, you must take added precautions.

Yes _____ No _____

3. How will the lead activities affect my job?

✓ How much additional time will lead-safe work practices take? See calculation aid on back.

Set up _____ hours

Work _____ hours

✓ How much will these practices cost? See checklist of tools and materials on back

Cleanup _____ hours

Labor \$ _____

Supplies \$ _____

4. What activities should the residents perform before I begin my lead-safe work practices?

✓ Examples include removing draperies, small furniture, and other fixtures from the work area.

Talk to the resident about specific activities

5. Other job related notes

CHECKLIST: MATERIALS AND SUPPLIES

Set up and Basic Tools

- | | | |
|---|---|---|
| <input type="checkbox"/> Protective clothing, coveralls | <input type="checkbox"/> Duct or masking tape | <input type="checkbox"/> Chemical stripper (avoid methylene chloride) |
| <input type="checkbox"/> Disposable shoe covers | <input type="checkbox"/> 4-6 mm polyethylene sheeting | <input type="checkbox"/> Window opening tool |
| <input type="checkbox"/> N100 Dust Mask | <input type="checkbox"/> Utility knife | <input type="checkbox"/> Plane |
| <input type="checkbox"/> Painter's hats | <input type="checkbox"/> Rope or other barrier | <input type="checkbox"/> Heat gun |
| <input type="checkbox"/> Paint scraper | <input type="checkbox"/> Misting bottle | <input type="checkbox"/> Disposable hand towels |

Specialized Tools - Hepa Filters

- | | | |
|---|---|--|
| <input type="checkbox"/> Needle gun with HEPA exhaust | <input type="checkbox"/> HEPA exhaust attachments for power tools (sanders, grinders, planers, shavers) | <input type="checkbox"/> Power washing equipment |
|---|---|--|

Clean up Supplies

- | | | |
|--|---|--|
| <input type="checkbox"/> Two-sided bucket | <input type="checkbox"/> Misting bottle | <input type="checkbox"/> Heavy-duty garbage bags |
| <input type="checkbox"/> 3-4 disposable mop heads and mop handle | <input type="checkbox"/> General or lead-specific Cleaning solution | <input type="checkbox"/> Duct-tape |
| <input type="checkbox"/> HEPA filtered vacuum | <input type="checkbox"/> Disposable hand towels | <input type="checkbox"/> Shovel and rake |

Addressing Lead-Based Paint Hazards During Renovation, Remodeling, and Rehabilitation in Federally Owned and Assisted Housing

Hours and Cost Calculation

	Set up	Work	Clean up	Total
Labor Hours (total)				
Labor Cost (total)	\$	\$	\$	\$
Supplies	\$	\$	\$	\$
Total	\$	\$	\$	\$

RESOURCES FOR ADDITIONAL INFORMATION

Where can I get copies of the *Protect Your Family From Lead in Your Home* pamphlet?

Download electronic copies at: www.epa.gov/lead

- ✓ Use camera-ready copies from the National Lead Information Center to reproduce the pamphlet, providing that you reproduce the text and graphics in full: 1-(800) 424-LEAD (5323).
- ✓ Order bulk copies from the Government Printing Office (GPO) which cost \$26.00 for a package of 50 pamphlets: (202) 512-1800; refer to the pamphlet by name or by GPO Stock Number 055-000-00507-9.

Where can I get copies of *The Lead-Based Paint Pre-Renovation Education Rule* handbook?

Download electronic copies of the interim edition (June 1999) in PDF format at <http://www.epa.gov/opptintr/lead/interior2.pdf>

- ✓ Contact the National Lead Information Center at: 1-(800) 424-LEAD (5323)

Where can I find additional information and resources related to lead-based paint?

- ✓ National Lead Information Center: 1-800-424-LEAD (5323)
- ✓ EPA's Office of Pollution Prevention and Toxics (OPPT): www.epa.gov/lead, 202-260-3810
- ✓ HUD's Office of Healthy Homes and Lead Hazard Control: www.hud.gov/offices/lead, 202-755-1785, ext. 104.

Summary

◆ Class discussion

- List key safe work practices and equipment

02/23/2001



4-15

Module 5

Clean-Up and Check Your Work

02/23/2001



5-1

100

Module 5 Overview

- ◆ **What is effective clean-up?**
- ◆ **Cleaning tools**
- ◆ **Interior cleaning techniques**
- ◆ **Exterior cleaning techniques**
- ◆ **How to check your work and achieve clearance**
- ◆ **Safe disposal methods**

02/23/2001



5-2

What you will learn in this module

In this module, we will cover all the topics listed on the slide above.

- The goal of clean-up is to leave the work area as clean or cleaner than when you arrived so that, as a result of your work, lead dust is not left behind to poison the residents of the home.
 - At the end of this module, you will know how to check your work to ensure the work area is clean enough to pass a clearance examination. See Appendix 2 for a discussion of HUD requirements, which include clearance examination.
- By using the techniques described in the following pages of this module you will be able to clean a work area quickly and efficiently. Remember, approaching a clean-up is similar to approaching a job. Proper preparation and planning will help make your cleaning efforts more effective and faster.
- Always schedule time at the end of each day to clean thoroughly.

What is Effective Clean-Up?

- ◆ **Containing dust during clean-up to the area that will be cleaned**
- ◆ **Using proper cleaning techniques**
- ◆ **Cleaning all surfaces, tools and clothing**
- ◆ **Checking your work - clearance examination**
 - Visual assessment
 - Clearance testing
- ◆ **Safe and secure disposal**

02/23/2001



5-3

Containment

- Effective cleaning begins with proper preparation and containment. Clean-up will be much easier and efficient if proper containment has kept all dust and debris confined to the work area. Also, containing dust to the area that is being cleaned is important.

Proper cleaning techniques

- You should be careful not to spread dust and contaminate other areas while cleaning. Using the techniques outlined in this module and following the proper sequence will help ensure that you do not contaminate other areas while cleaning.

Cleaning all surfaces

- "All surfaces" includes vertical surfaces such as walls and windows and horizontal surfaces such as floors, door tops, window troughs, and window sills. Cleaning should proceed from high to low, i.e., from top of wall to window to floor.

Checking your work

- Always conduct a visual inspection after any job. Look for any visible paint chips, dust or debris.
- A trained individual (sampling/clearance technician, LBP inspector or risk assessor) who did not do the work will perform the clearance examination. Check state requirements for acceptability of "sampling technicians" performing this activity.

Safe and secure disposal

- Bag and "gooseneck seal" all waste in heavy duty plastic bags such as 4-6 mil poly-bags. Safely dispose of all waste in accordance with state and federal regulations.

Clean-Up Toolkit

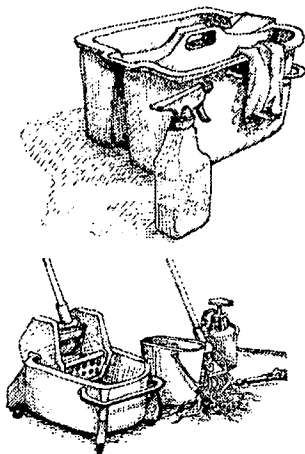

- ◆ Vacuum with HEPA filter
- ◆ Misting bottle and pump sprayer
- ◆ Mop with disposable heads
- ◆ Detergent
- ◆ Two buckets or two-sided bucket
- ◆ Disposable hand towels
- ◆ Heavy duty garbage bags
- ◆ Duct tape
- ◆ Shovel and rake

02/23/2001



5-4

Clean-Up Toolkit

- The tools listed on the slide above are for cleaning interior and exterior jobs. Some tools, such as the pump sprayer, shovel, and rake are used primarily for exterior clean-up. Other tools, such as the buckets and mops are used primarily for interior clean-up.
- The following pages discuss clean-up for both interior and exterior situations.
- These items supplement the Job Set-Up (slide 3-6) and Safe Work Practices (slide 4-8) Toolkits.

Interior Clean-Up Techniques

- ◆ **Clean-up all paint chips and debris**
- ◆ **Pick up protective sheeting**
 - Mist sheeting before folding
 - Fold dirty side inward
 - Tape shut to seal in dirty side
- ◆ **Dispose of protective sheeting at end of job**

02/23/2001



5-5

Pick up

- Always begin a clean-up by picking up all paint chips and any visible debris with a wet disposable cloth.

Protective sheeting

- Protective sheeting may be used again within the same work area if it has not already been folded (see pp. 47, Lead Paint Safety Field Guide). When the job is complete, clean protective sheeting using a HEPA vacuum. Protective sheeting should then be folded and taped shut. Always fold dirty side inwards, seal and place in heavy duty plastic bags such as 4-6 mil poly-bag. "Gooseneck-seal" the poly-bag and dispose with the rest of your waste at the end of the job.

Interior Clean-Up Techniques

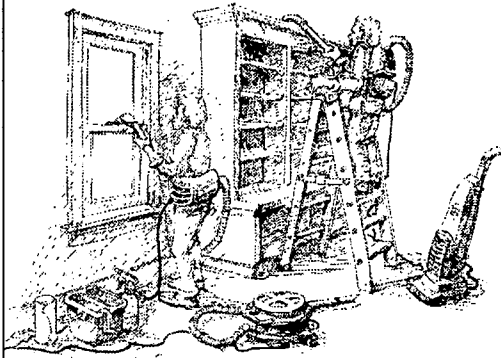

02/23/2001

- ◆ **HEPA Vac work area from high to low**
 - Start with walls, tops of doors, window troughs
 - HEPA Vac at least two feet beyond contained area
- ◆ **Wet clean from high to low**
 - Change cloths and rinse water often
 - Clean the floor last
- ◆ **Clearance testing at end of job**



U.S. Department of Housing
and Urban Development

5-6

HEPA vacuum the contained work area from high to low

- Start with the walls, tops of doors, and window troughs (high) and work your way down to the floor (low).
- Clean walls with a HEPA vacuum or by lightly wiping with a damp disposable cloth.
- Be thorough-don't rush.

When cleaning wet, you can either mist the surface with cleaning solution or use a wet disposable cloth

- Work from high surfaces to low. If a surface is very dirty use a moist paper towel before beginning to scrub with a wet cloth.
- Replace cloths and change rinse water often.

Clean the floor last

- Work toward door
- Mist floor and clean with a wet mop using cleaning solution and the two-sided bucket.
- Clean at least two feet beyond contained area.
- Then, repeat the process using a new mop head and clean water.
- Remember, always keep one side of the bucket for cleaning solution and the other side for rinsing and wringing out the cloth or mop-head. Change the rinsing water often.

It may be necessary to repeat the HEPA Vacuum and Wet Clean. Always clean to clearance.

Interior Checking Your Work

◆ Conduct a visual inspection after cleaning

- Focus on child access areas such as floors, window troughs, window sills
- Look for paint chips, dust, debris, and deteriorated paint
- Inspect beyond work area
- Repeat clean-up steps if necessary

◆ Clearance testing at end of job ensures property is now safe for children

- Required when work is above de minimis levels in federally-assisted housing.
- If area fails clearance, re-clean and retest.

02/23/2001



5-7

Clearance Testing has two parts:

Visual inspection (HUD refers to this as “visual assessment”)

- A thorough visual inspection should be the first step of checking your clean-up. Any visible paint chips, dust or debris should be collected and disposed.
- **Visual inspection will not verify that a work area has been cleaned adequately.** In many instances lead dust is not visible to the naked eye and will not be detected during a visual inspection. To ensure that a work area is properly cleaned, follow the practices outlined in this section and take dust wipe samples using a qualified person to conduct clearance.

Dust sampling

- Dust sampling can be performed to check the effectiveness of the clean-up efforts.
- In some cases, such as with federally assisted work or under some state and local laws, dust sampling may be required as part of “clearance” (a defined process to ensure that a work area is not contaminated with lead dust after work is completed). In such cases, dust sampling must be performed by a certified or trained person. Supervisors should be aware of state laws regarding renovation, remodeling, and rehabilitation work and clearance testing.

The de minimis levels are:

- 20 square feet on exterior surfaces
- 2 square feet in any one interior room or space
- 10 percent of the total surface area on an interior or exterior type of component with a small surface area

Exterior Clean-Up Techniques

- ◆ **For high-dust jobs mist area to keep dust down**
- ◆ **Visually inspect work area**
 - **Look for dust, debris, and paint chips**
 - **Focus on child access areas such as:**
 - **Window sills**
 - **Bare soil and ground**
 - **Play areas**

02/23/2001



5-8

High-dust jobs

- After completing a high-dust job, such as power sanding a painted surface, mist the entire work area to keep dust from spreading.

Visual inspection

- A thorough visual inspection of the work area should be conducted after any exterior job. Any visible paint chips, wood chips or other debris from the work area should be collected and disposed with the rest of your waste.
- Focus your visual inspection on areas where children may play or be exposed to lead contaminated dust or debris. Such areas include exterior porches, outside play areas, bare soil and ground, and window sills.

Remember

- Lead contaminated soil can poison children.
- Avoid dry raking and spreading dust.

Exterior Clean-Up Techniques

◆ Pick up protective sheeting

- Collect and dispose of any debris or chips on sheeting
- HEPA vacuum sheeting
- Clean sheeting until it passes visual inspection
- Dispose of sheeting properly

◆ Visually inspect beyond work area

02/23/2001



5-9

Protective sheeting

- If protective sheeting or landscape fabric will be disposed at the end of the job, it should be cleaned and disposed with the rest of your waste.

Specific exterior jobs

- If work takes place on an exterior porch or stairwell, HEPA vacuuming, wet cleaning and mopping, in addition to a thorough visual inspection, should be used to clean the work area. For such jobs the clean-up can be similar to clean-up after interior jobs. Collect and dispose of any dust or debris with the rest of your waste.

Exterior Checking your Work

◆ Visual inspection

- Always conduct a visual inspection after any cleaning
- Focus on child access areas such as
 - Bare soil or ground
 - Window sills
 - Exterior porches
 - Play areas
- Inspect beyond work area

◆ Collect and dispose all paint chips, dust, debris, and deteriorated paint



U.S. Department of Housing
and Urban Development

02/23/2001

5-10

Checking your work

- A thorough visual inspection is the main part of checking your clean-up after an exterior job. You should collect and dispose of any visible paint chips, wood chips and debris found during the visual inspection. Child access areas include porches, play areas, bare soil or ground, and window sills.
- You may notice that the processes of clean-up and checking your work are similar for exterior jobs. A visual inspection is conducted once while cleaning and **again** after completing clean-up to check your work. Both visual inspections should be thorough and focus on collecting and disposing all visible paint chips, dust and debris.

HUD Requirements in Federally Assisted Housing

- ◆ For work on pre-1978 housing or buildings that have not been found to be free of lead-based paint, the unit must pass clearance if the work is above the de minimis levels.
- ◆ A clearance examiner will:
 - Conduct visual inspection of the work area or unit
 - Interior and exterior
 - Take dust samples from
 - Floors
 - Windows
 - Provide a written report with results
 - Be certified or have work approved by a certified inspector or risk assessor

02/23/2001



5-11

Clearance

- Clearance is required in pre-1978 housing that has received HUD assistance and has not been found to be free of lead-based paint by an EPA or State certified risk assessor or inspector. In these cases, clearance must be conducted by an independent, certified clearance examiner or a trained technician. This person may be called a "sampling technician" or "clearance technician." Certified inspectors or risk assessors may also perform clearance examinations. Individual state requirements may vary, therefore, check state requirements to determine who may perform clearance testing.
- Clearance involves
 - A visual inspection to identify remaining deteriorated paint, dust, debris, and paint chips.
 - Dust sampling on floors and windows.
 - A written report with the results of the clearance examination.
- A unit or property that does not pass clearance must be re-cleaned and go through clearance again.
- The HUD rule is summarized in Appendix 2.

Disposal

◆ What should I do with my waste?

◆ At the work site

- Place waste in heavy duty plastic bags such as 4-6 mil poly-bag
- “Gooseneck Seal” the bag with duct tape
- Carefully dispose of waste in accordance with state and federal regulations
- Store waste in secure area.



02/23/2001



5-12

At the work site

- Always collect, bag and seal your waste at the work site and in the work area. Do not carry your waste to another room or another area before bagging and sealing the waste. Store all waste in a secure container or dumpster until disposal. Limit on-site storage time. Avoid transporting waste in an open truck. Some examples of waste include:
 - Protective sheeting
 - HEPA filters
 - All paint chips, dust and dirty water
 - Used cloths, wipes and mop heads
 - Any debris
 - Protective clothing, respirators, gloves
 - Architectural components

Waste water

- Water used for clean-up should be filtered and dumped in a toilet. Never dump this water down a sink, storm drain, on the ground, or in a tub. Always be aware of state and local regulations regarding waste water disposal.

Remember

- If needed, “double-bag” your waste to help prevent the waste from escaping if the bag is cut or ripped.

111

02/23/2001

Disposal - Local and Federal Information

- ◆ **Separate residential architectural components from hazardous waste**
- ◆ **Segregate hazardous and non-hazardous waste**
- ◆ **Minimize hazardous waste**
- ◆ **Always check State regulations!**

02/23/2001



5-13

Waste disposal issues

- You should determine whether you generate more than 220 pounds of hazardous waste per job site per month. If you have less than 220 pounds per location per month then manage this waste as solid, non-hazardous waste. If you generate more than 220 pounds of hazardous waste you should contact your state and local regulators to find out how to dispose of this waste properly.
- Some **possible** examples of **hazardous waste** may include: paint chips; vacuum debris; sludge or chemical waste from strippers; and HEPA filters.
- Some **possible** examples of **non-hazardous waste** may include: disposable clothing; respirator filters; rugs and carpets; protective sheeting; and solid components with no peeling paint. Please list and suggest any other examples.
- All waste should be handled carefully and sealed in heavy duty plastic bags such as 4-6 mil poly-bags.
- Large architectural components from residential housing should be wrapped and sealed in plastic sheeting and disposed along with your waste.

Remember

- Some states have enacted more stringent waste management and disposal regulations.
- Supervisors must be aware of state regulations concerning hazardous and solid waste management and disposal.

Keep In Mind

- ◆ **Schedule time to clean thoroughly at the end of each day**
- ◆ **Assign responsibilities to specific personnel**
- ◆ **Create and maintain a checklist for cleaning procedures**
- ◆ **Always maintain sufficient cleaning and disposal supplies**
- ◆ **Achieve Clearance**

02/23/2001



5-14

Example check list for cleaning procedures

The list below is an example checklist for cleaning procedures. You may wish to add to or modify it to fit your needs.

- Was the work completed?
- Have all visible paint chips, dust and debris been removed and disposed?
- Was the protective sheeting folded, sealed, and disposed?
- Was the interior work area HEPA vacuumed?
- Were all surfaces wet cleaned? Was the floor cleaned last?
- Was the interior work area HEPA vacuumed again?
- Was all waste placed safely in heavy duty plastic bags such as 4-6 mil poly-bags?
- Were all bags properly sealed?
- Was all waste disposed in accordance with state and federal regulations?
- Was a visual inspection completed?
- Were dust samples taken?
- Is the property owner satisfied?

APPENDIX 1

Lead Paint Safety: A Field Guide for Painting, Home Maintenance, and Renovation Work



Lead Paint Safety

**A Field Guide for
Painting, Home
Maintenance, and
Renovation Work**

U.S. Department of Housing
and Urban Development
Office of Lead Hazard Control

Acknowledgements

The U.S. Department of Housing and Urban Development (HUD) developed this guide with the assistance and input of the Centers for Disease Control and Prevention (CDC), the U.S. Environmental Protection Agency (EPA), and the Occupational Safety and Health Administration (OSHA). HUD would like to thank the staff of these agencies for their participation in developing this Field Guide. HUD would also like to thank all of the renovation, painting, maintenance, and lead professionals who provided useful feedback. Vicki Ainslie, Dana Bres, Robert Brown, Kevin Cleary, Alan Isaac, David Levitt, Linda Lewis, Dennis Livingston, Eric Oetjen, Roy Reveilles, Ron Rupp, Joe Shirmer, Aaron Sussell, Peter Tiernan, David Thompson, Richard Tobin, Ellen Tohn, Veda Watts, and Mike Wilson served on the Technical Panel for this project. A special thanks goes to these individuals for their contributions.

This Guide was developed by the U.S. Department of Housing and Urban Development's Office of Lead Hazard Control through a contract with ICF Incorporated. Dennis Livingston created the illustrations and provided technical content for this Field Guide.

WHY SHOULD I FOLLOW THIS GUIDE?

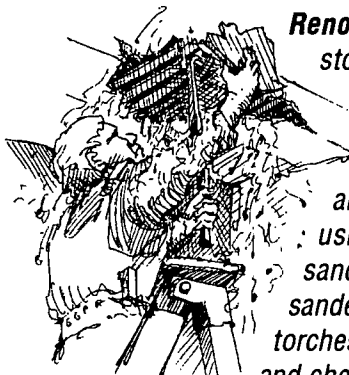

Renovation of a two-story, 19th century house included removing paint from floors and woodwork using power sanders, hand sanders, scrapers, torches, heat guns, and chemical paint strip-

pers. Ceilings were also repaired, and wallpaper and paint were removed from several walls. The family that owned the home temporarily moved out of the house. They returned when the work was only partly completed. There was dust throughout the house.

The family discovered that something was wrong when one of the family's dogs began to have seizures. A veterinarian found that the dog had been lead poisoned. The mother and children had their blood tested, and found that all of them had very high levels of lead in their blood. All three were admitted to the hospital for severe lead poisoning.

A painter was hired to repaint the exterior of an old

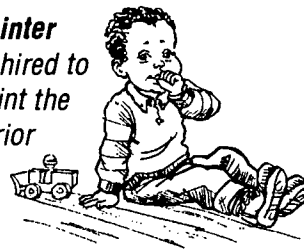

Vermont home occupied by a couple expecting the birth of their first child. The painter used a power grinder to remove the old paint from the exterior siding. While the painter worked, the window to the baby's nursery was left open, and the entire room, including the crib, became covered with dust.

Fortunately, the couple noticed the dust, and understood the potential risk. They called in another painter who was qualified to control lead hazards. He cleaned up the paint dust and the newborn baby moved into a clean, safe home.

Most Old Homes Contain Lead-Based Paint

- Most homes built before 1978 contain some lead-based paint. Lead-based paint is more common and was used more extensively in homes built before 1950.

Probability of a House Containing Lead

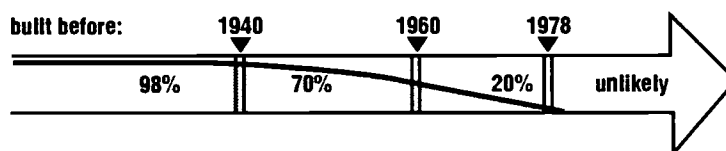

- Homes built before 1950 also used paint that had a higher concentration of lead.

WHY FOLLOW THIS GUIDE?

1

Poor Maintenance Endangers Children

- In poorly maintained houses, lead-based paint, which may be several layers down, flakes and peels off. Paint failure is usually caused by moisture problems. Sometimes rubbing or impact causes paint failure. Doing work improperly can also cause a lot of dust.
- Lead-based paint chips and dust then mix with house dust and build up in window troughs and on floors.
- Children are endangered when lead in paint chips, dust, and soil gets on their hands and toys which they may put in their mouths.
- Lead can make children very sick and cause permanent brain and nerve damage. It can also result in learning difficulties and behavior problems. This damage is irreversible. It is a tragedy we can prevent.
- If paint is kept intact and surfaces are kept clean, children can live safely in a home painted with lead-based paint.
- Uncontrolled or uncontained dust and debris from repainting and/or renovation that disturbs lead-based paint in a well-maintained home can also expose children to unsafe levels of lead.

Changing Common Work Practices Can Protect Workers and Children

- Lead-based paint can also pose a threat to workers by causing damage to their brains, and nervous and reproductive systems.
- With small changes in work practices, workers can protect themselves and their customers from lead exposure.
- These changes include:
 - Keeping dust to a minimum.
 - Confining dust and paint chips to the work area.
 - Cleaning up during and after work. Special cleanup procedures must always be used.
 - Taking dust wipe samples to make sure cleaning removed lead-contaminated dust. (Dust wipe sampling is described in Section 5D, p. 71.)

Who Should Use This Guide?

- Building maintenance workers and their supervisors
- Painters
- Repair, renovation, and remodeling contractors
- Property managers and owners
- Homeowners
- Local housing agency staff and public health staff

When Should I Follow This Guide?

- To fix a specific problem.
- During routine maintenance or apartment turnover.
- In homes where there may be a young child or a pregnant woman.
- During work supported by Federal funds that must be performed using safe work practices under Federal regulations.

HOW TO USE THIS GUIDE

This guide is divided into 5 sections.

To locate a section, bend the bottom of these pages. Look for the section you want by lining up the boxes at the bottom of each page.

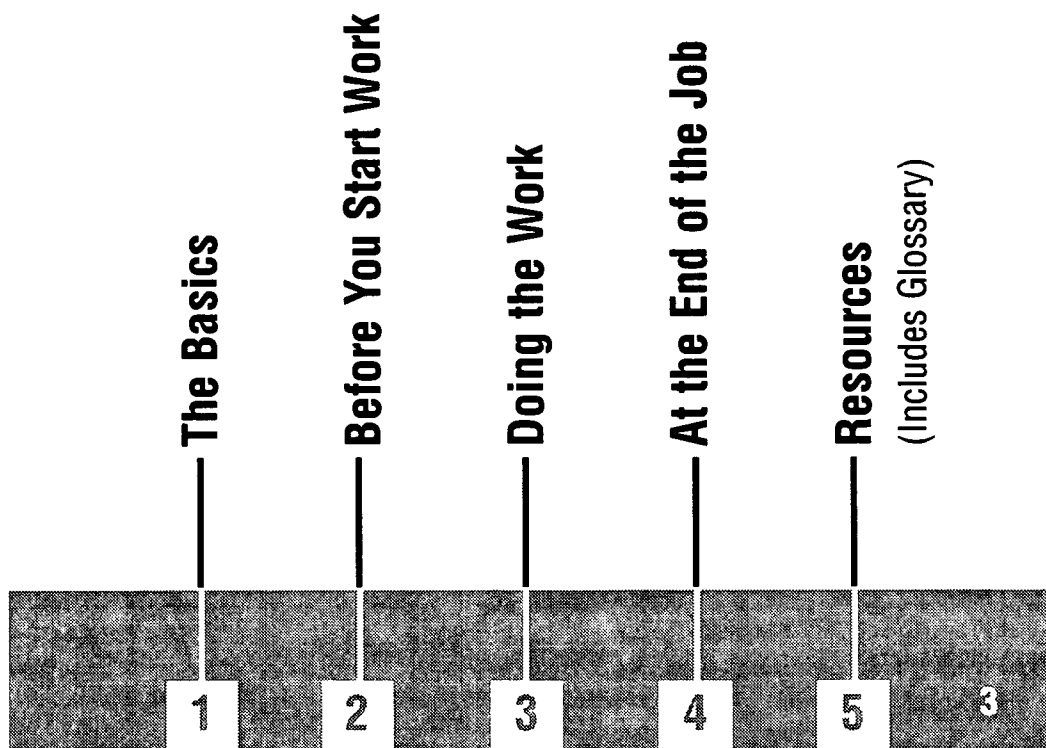
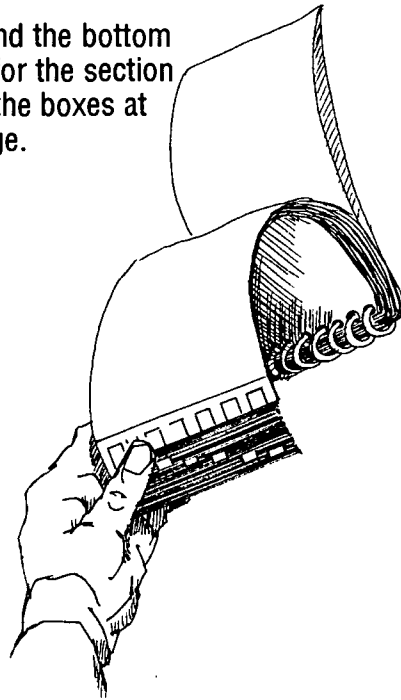

CONTENTS OF THIS GUIDE

1. The Basics	.5
Remember these Principles	.5
Routine Work Practices	.6
Correcting the Cause of the Problem	.7
Restricted Practices	.9
Key Stages of a Job	.11
2. Before You Start Work	.13
Set Up the Work Area - Interior	.13
Set Up the Work Area - Exterior	.15
Worker Protection	.17
3. Doing the Work	.19
Painting Jobs	
<input type="checkbox"/> Interior Surface Prep	.19
<input type="checkbox"/> Exterior Surface Prep	.22
<input type="checkbox"/> Paint Removal	.23
Home Maintenance and Renovation Jobs	
<input type="checkbox"/> Walls/Ceilings	.25
<input type="checkbox"/> Windows	.29
<input type="checkbox"/> Doors	.37
<input type="checkbox"/> Stairs/Floors	.41
<input type="checkbox"/> Trim	.43
<input type="checkbox"/> High Dust Jobs	.45
4. At The End of the Job	.47
Cleaning Up	.47
Disposal of Waste	.49
Checking Your Work	.51
Ongoing Monitoring & Maintenance	.53
5. Resources	.55
A. Glossary	.55
B. For More Information	.57
C. Getting the Word Out	.65
<input type="checkbox"/> <i>How Owners and Occupants Can Work Together to Improve Lead-Safety in Homes</i>	
<input type="checkbox"/> <i>Notice Prior to Renovation</i>	
<input type="checkbox"/> <i>Why Lead Safety Makes Sense for Property Owners and Contractors</i>	
D. More About Technical Topics	.69
<input type="checkbox"/> <i>Respiratory Protection</i>	
<input type="checkbox"/> <i>Testing Dust for Lead</i>	
<input type="checkbox"/> <i>Setting Up a Dust Room</i>	
<input type="checkbox"/> <i>Building a Door Hold</i>	
E. Tool and Supply List	.75
F. Notes and Special Instructions	.77
G. Work Checklist and Disclaimer	.Back Cover

REMEMBER THESE PRINCIPLES

- 1. ASSUME:** **Paint in Homes Built Before 1978 Contains Lead**
(Unless a lead-based paint inspection shows it doesn't.)
Exposing Anyone to Dust, Especially Children, is Bad
- 2. CHECK:** **Federal, State, and Local Regulations**
 - OSHA has rules for worker safety
 - EPA and your local community have rules for waste disposal
- 3. AVOID:** **Creating Dust**
 - Use low dust work practices (for example, mist surfaces with water before sanding or scraping)**Spreading Dust**
 - Cover area under work with durable protective sheeting (plastic or poly)
 - Keep dust contained to immediate work area
- 4. PROTECT:** **Occupants, Particularly Children**
 - Keep them away from work area
 - Clean up work site before they return**Workers**
 - Wear proper respiratory protection for lead dust
 - Keep clean
 - Don't take dust home
- 5. CLEAN UP:** **After All Work**
 - Clean up is particularly important if painted surfaces were broken or wall cavities were opened
 - Take dust wipe samples to make sure that it is safe for children to return
- 6. MAINTAIN:** **A Dry Building**
 - Moisture problems can cause paint failure, building deterioration, and encourage pests**All Painted Surfaces**
 - Well-maintained paint generally does not pose a health risk**Clean and Cleanable Surfaces**
 - Keep floors and painted surfaces smooth
 - Damp mop them often
 - Clean rugs and carpet well

THE BASICS

1

5

ROUTINE WORK PRACTICES

The following pictures appear throughout the Guide and refer to specific sections covering these practices.

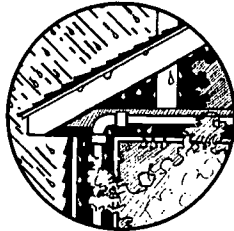

Correct the Cause of the Problem. Before work starts, correct the conditions causing damage to the home. See Correcting the Cause of the Problem, p. 7.

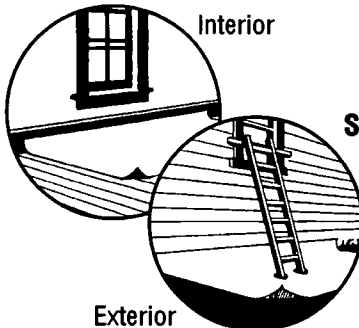

Interior

Set Up Work Area. Set up the work area properly. See Section 2: Set Up the Work Area - Interior & Exterior, p. 13 and p. 15, respectively.

Exterior

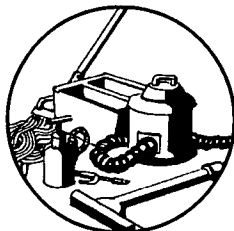

Clean Up and Clear. Thoroughly clean up the work area using the procedures described in this guide. Then, take dust wipe samples to see if it is safe for children to return. See Section 4: Cleaning Up, p. 47 and Check Your Work, p. 51.

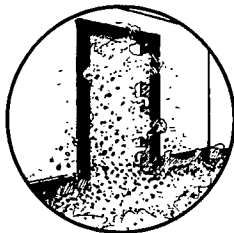

High Dust Jobs. Some activities are likely to create high amounts of dust during the job. See Section 3: High Dust Jobs, p. 45 and follow the guidelines in this section to ensure that this work is performed safely.



Important!!! This symbol points out important details where special attention is needed.

CORRECTING THE CAUSE OF THE PROBLEM

If a job involves repairs to a damaged paint surface, it is important to correct the cause of the damage, or the damage will occur again. Damaged surfaces that contain lead-based paint represent a health threat to the occupants.

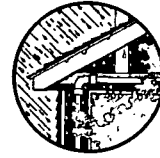

The following conditions are examples of potential causes of damage to painted surfaces. Be sure that the planned work will correct these conditions if they are present.

Moisture From Outside

Roof leaks; incorrectly installed flashing; defective downspouts and gutters; water collecting in window troughs; puddles of water at foundations; leaking basement walls; wet crawl spaces.

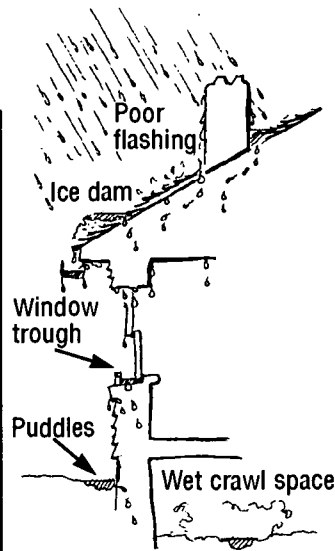

Moisture From Inside

Attic condensation due to poor ventilation; unvented steam from showers and cooking; leaking plumbing and failed seals around tubs and toilets; condensation in walls; unvented dryers; wet and poorly maintained basements.

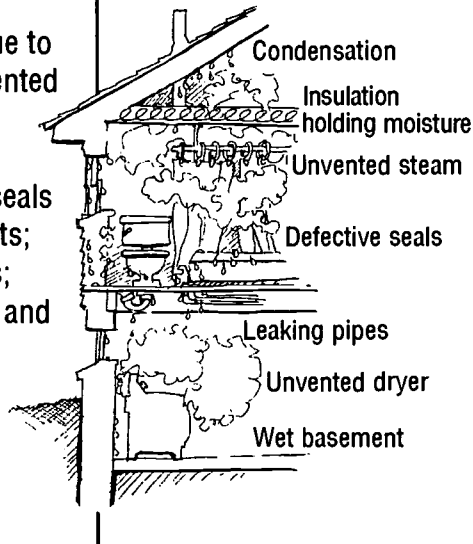

THE BASICS

Rubbing and Impact of Painted Surfaces

Binding doors; unprotected painted walls and trim; and rubbing from opening and closing painted windows.

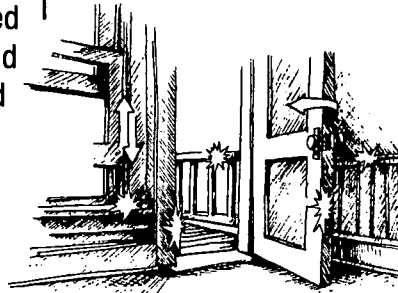

Places that Collect Dust and Paint Chips

Where feasible, repair or remove places where dust and paint chips may accumulate and can't be easily cleaned (such as old wall-to-wall carpet and unused items stored in the basement).

If these places are damp, they may also be home to mold. Keep flat surfaces (such as window stools or interior sills and troughs) clean and cleanable.

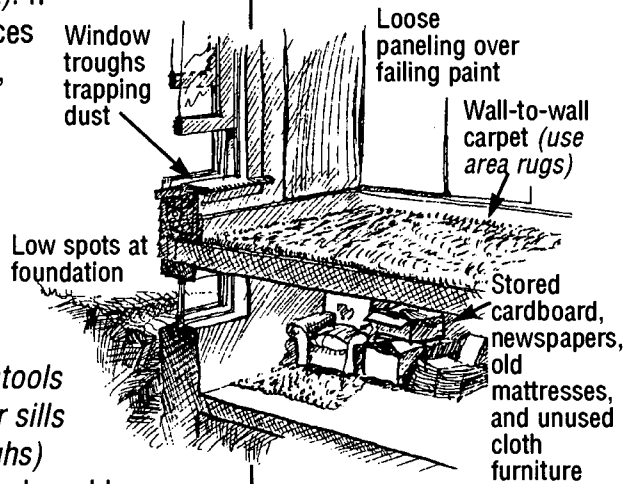

Structural Damage

Some surface damage may be caused by structural damage such as wood rot, termites, foundation settlement, and foundation shift. These problems must be addressed before surface repairs are made.

RESTRICTED PRACTICES

Goal: Don't use unsafe work methods. Some work methods create such high levels of dust that they must not be used when working on surfaces that may contain lead-based paint.

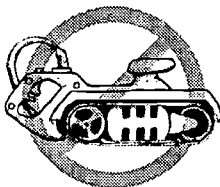

Don't Use Power Sanders or Grinders Without HEPA Vacuum Attachment.

These machines create a lot of dust that can contaminate a building and the ground around a building endangering workers, neighbors, and occupants.

Controlled Sanding or Grinding With HEPA Vacuum Attachment Is Acceptable.

If the sanding or grinding machines are "shrouded," which means surrounded with a barrier that prevents dust from flying out around the perimeter, AND attached to a HEPA vacuum, they can be used. Because some dust may still blow out around the perimeter, workers near the machine should wear half-mask respirators rated by NIOSH as N100 (or HEPA) at a minimum. Also, the work area must be completely isolated if the machine is used inside (see Section 3: [High Dust Jobs](#), p.45). Because these tools can create high levels of dust and require additional precautions, their use is beyond the scope of this guide.

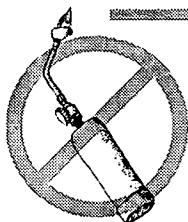
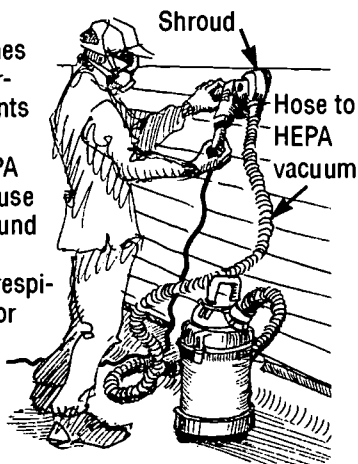

Don't Use Open Flame/High Heat Removal of Paint.

There is no acceptable use of an open flame torch or high temperature heat gun (above 1100 degrees F) to remove paint.

- It produces toxic gases that a HEPA dust canister on a respirator cannot filter out on its own (a second, organic filter is necessary).
- It creates high levels of very toxic dust that is extremely difficult to clean up.
- It can burn down a house.

Do Use a Heat Gun on Low Setting.

A heatgun set below 1100 degrees F may be used with caution. It is recommended for small areas only, such as the edge of a door, the top of a window stool, or the friction surface of a window jamb.

THE BASICS



Don't Use Paint Strippers Containing Methylene Chloride.

Many paint strippers are potentially dangerous. Strippers containing methylene chloride should not be used because this chemical is extremely toxic and is known to cause cancer.

Other Chemical Strippers with Appropriate Precautions Are Acceptable.

Chemical strippers without methylene chloride are safer to use, as long as the precautions printed on the container are followed. Take extra precautions to mask areas near stripping.

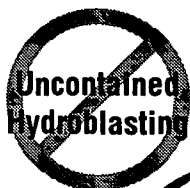

Don't Use Uncontained Hydroblasting.

Removal of paint using this method can spread paint chips, dust, and debris beyond the work area. This result makes it difficult to clean up these hazards at the end of the job.

Contained Pressure Washing Is Acceptable.

Removal of paint using contained pressure washing within a protective enclosure to prevent the spread of paint chips, dust, and debris may be done. Because this method requires additional precautions that are beyond the scope of this guide, it should only be used by certified lead abatement workers.



Don't Use Uncontrolled Abrasive Blasting.

This work method can also spread paint chips, dust, and debris beyond the work area. This result makes it difficult to clean up these hazards at the end of the job.

Contained Blasting Is Acceptable.

Contained abrasive blasting within a protective, locally exhausted enclosure to prevent the spread of paint chips, dust, and debris may be used. Because this method requires additional precautions that are beyond the scope of this guide, it should only be used by certified lead abatement workers.



Avoid Extensive Dry Scraping or Sanding.

Extensive dry scraping or sanding create large amounts of paint chips, dust, and debris that are hard to contain.

Use Wet Methods or Limited Dry Scraping and Sanding.

Mist surfaces before scraping and sanding. Continue to mist while working. Dry scraping or sanding of very small areas (for example, around light switches or outlets) may be done if flat surfaces below these areas are covered with protective sheeting. These methods should be avoided on areas larger than 2 square feet per room, and workers must have adequate respiratory protection.

KEY STAGES OF A JOB

Quality work requires thinking through the job from start to finish. Here are the basic stages of the jobs described in this guide.

Before Starting	<ul style="list-style-type: none">• Find the causes of damage• Prioritize work• Hand out lead hazard information pamphlet (see note below)
Work	<ul style="list-style-type: none">• Set up work area<ul style="list-style-type: none">— Separate work space from occupied space— Isolate high dust areas• Correct cause(s) of problem(s)• Complete the job using safe work practices, such as those shown in this guide
Finish the Job	<ul style="list-style-type: none">• Clean up thoroughly• Dispose of waste safely• Check quality of work and correct problems
Maintain the Work	<ul style="list-style-type: none">• Educate occupants about risks from lead-based paint• Maintain a safe and healthy home

Renovation Notice About Lead Safety

Note: Federal law requires that owners and occupants of a house or apartment built before 1978 receive the pamphlet *Protect Your Family From Lead In Your Home* prior to the start of renovation work. The requirement applies to any work that will disturb a painted surface larger than 2 square feet when the work is done by:

- Contractors who have been hired to do any kind of work. Among others, this can apply to painting, drywall, and electrical trades.
- Owners of rental properties who have work performed by maintenance staff.

See p. 67 for more information about this requirement.

THE BASICS

1

11

SET UP THE WORK AREA – INTERIOR

Restrict Access

- Ask occupants to leave the room where work will be done.
- Have them stay out until final cleanup.
- Place “DO NOT ENTER” tape across doorway or post sign.

Caution: If the work will create a large amount of dust, follow the guidelines in Section 3: High Dust Jobs, p. 45.

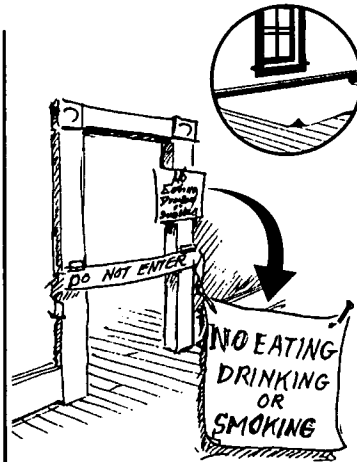

Protect Floor

- Place protective sheeting on floor extending about 5 feet from the work area.
- Tape protective sheeting to the baseboard under work area using masking tape (or durable tape where masking tape doesn't work).

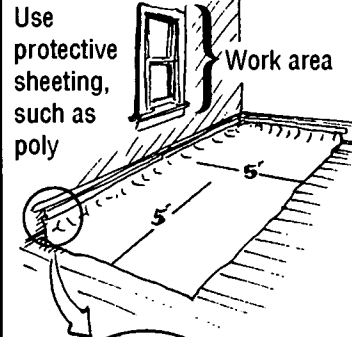

Use protective sheeting, such as poly

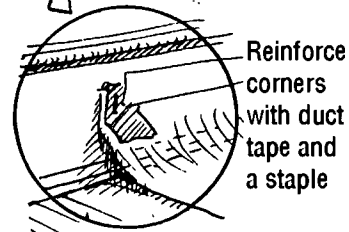

Reinforce corners with duct tape and a staple

Protect Furnishings

- Remove drapes, curtains, furniture, and rugs within 5 feet of work area.
- Cover any furniture within 5 feet of work area that cannot be moved.

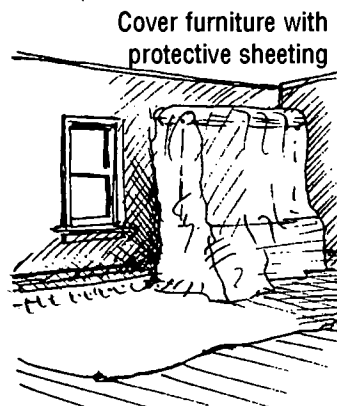

Cover furniture with protective sheeting

Stock the Work Area

- Put all necessary tools and supplies on protective sheeting before beginning work to avoid stepping off the protective sheeting.

BEFORE YOU START WORK

Tracking

- To avoid tracking dust off the protective sheeting, wear non-skid shoe covers on protective sheeting and remove them each time you step off the protective sheeting.

OR

- Wipe both top and bottom of shoes with a damp paper towel each time you step off the protective sheeting.

OR

- Clean off shoes using a tack pad (a large sticky pad that helps remove dust).

OR

- Remove shoes every time you step off the protective sheeting.

Set Up Dust Room (Optional)

- When working on components that can be moved, such as doors and window sashes, consider setting up a dust room. A dust room is an area isolated from occupied areas where workers can do dust generating work. The door of the room is covered with a flap and the floor is covered with protective sheeting. See [Section 5D: Setting Up a Dust Room](#), p. 73.

- Using a dust room contains dust and paint chips, and makes cleanup easier. It also helps protect occupants, as well as other workers.

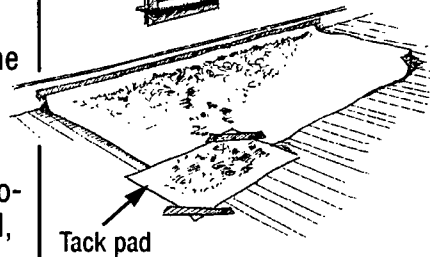
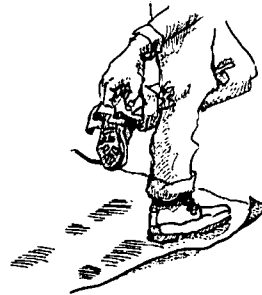

SET UP THE WORK AREA – EXTERIOR

Protect Ground

- When working on the ground floor, lay protective sheeting 10 feet from work surface or as space permits. When working on the 2nd story or above, extend the sheeting farther out.
- Vertical shrouding on scaffolding should be used if work is close to a sidewalk, street, or another property, or the building is more than three stories high.

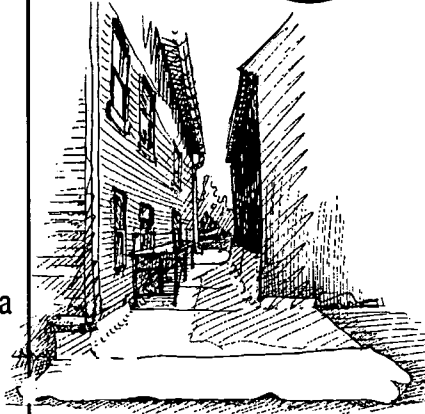
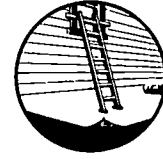

Important: Covering the ground protects the soil from contamination by lead-based paint chips and dust.

Attach Protective Sheeting to Wall

- Protective sheeting can be taped and/or stapled to wood siding or ribbon board. A wood strip may need to be attached to a masonry wall.

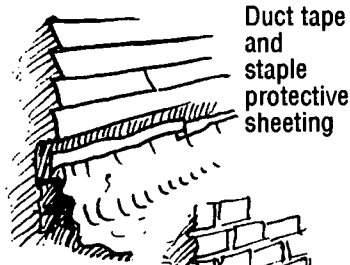

Duct tape and staple protective sheeting



Attach wood strip to brick to secure protective sheeting

Build Curb

- Build a curb around work perimeter when a sidewalk or another property is near, or when wind may blow debris off protective sheeting.

Curb edge of protective sheeting

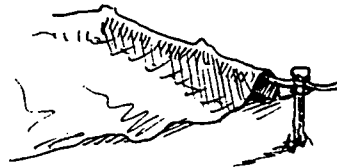

Caution: This may pose a tripping hazard.

BEFORE YOU START WORK

Cover Windows and Doors

Use Ladder Safely

- All windows and doors within 20 feet of the work area must be closed. If they cannot be closed, seal with protective sheeting during work.
- If an entrance must be used that is closer than 20 feet, place a shroud above and on the sides of the entrance.
- Don't use a metal ladder near power lines.
- Check feet and rungs of ladder to make sure they are sound.
- Place the base of the ladder at a distance from the wall using a height to base ratio of 4:1.
- Ladder should extend 3 feet past the top of the surface area where work will be done.
- If using protective sheeting to cover the ground, cut slots in the sheeting and place the ladder feet directly on the ground—not on top of the protective sheeting.
- Tie off the top of the ladder, where possible.
- If the work is taking place at heights above 10 feet, tie off the ladder and secure yourself with a lanyard and harness.

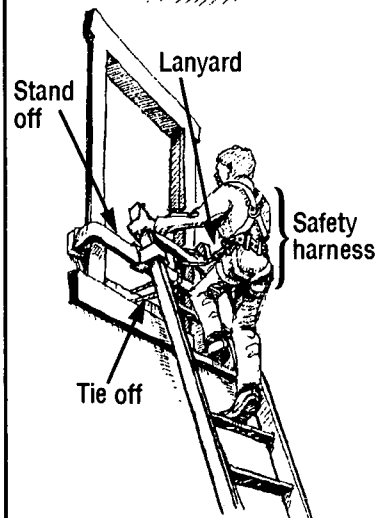
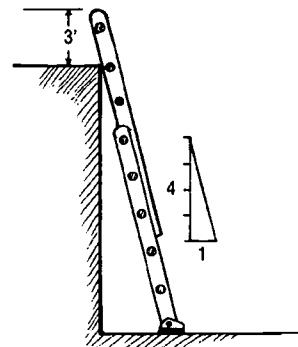
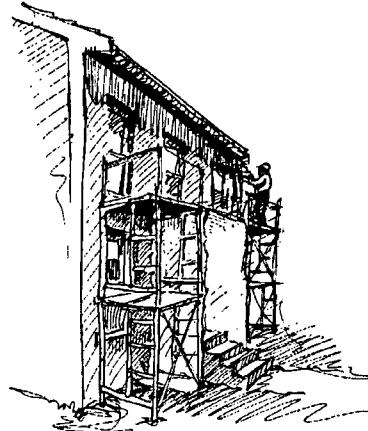
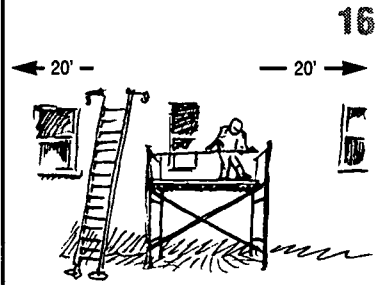

WORKER PROTECTION

Protect Your Eyes

- Always wear safety goggles or safety glasses when scraping, hammering, etc.

Keep Clothes Clean

- At end of work period, remove dusty clothes and/or vacuum off dust. Wash them separately. Do not use compressed air to blow dust off clothing.

OR

Use Disposable Covers

- Wear disposable protective clothing covers. Disposable protective clothing covers can be stored in a plastic bag and reused if fairly clean and there are no rips. Small tears can be repaired with duct tape.
- Wear painter's hat to protect head from dust and debris.

Wear Respiratory Protection

- When work creates dust or paint chips, workers should wear at least a NIOSH-approved respirator for lead work. See Section 5D: Respiratory Protection, p. 69.

Post Warning

- Post sign and avoid eating, drinking, or smoking on site.

Wash Up

- Wash hands and face each time you stop working.

Disposable suit & shoe covers

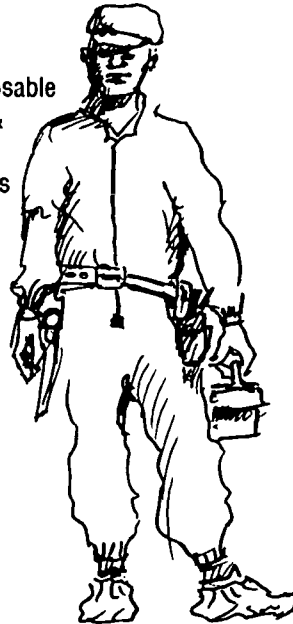

Sign at work site entrance

BEFORE YOU START WORK

INTERIOR SURFACE PREP

PROBLEM SOLUTION

A wall or ceiling is sound, but has holes, uneven surfaces, or flaking and peeling paint.

Prepare wall or ceiling to create a sound, intact surface for painting. Use methods that create a minimum amount of dust.

- Set Up**
- Remove Deteriorated Paint**
- Fill and Patch Holes**
- Prep Surface**
- Clean Up and Clear**

- See Section 2, p. 13.
- Wet scrape any loose, peeling, or flaking paint.
- If removal of damaged edges is necessary, mist surface before removal.
- Skim and fill holes and cracks less than 1/16 inch wide with a non-shrinking spackle compound.
- If sanding is necessary to feather edge, use wet abrasive sponge or wet-dry sandpaper with water.
- Clean wall, particularly in kitchen area.
- De-gloss surfaces as necessary (use liquid sandpaper or wet-dry sandpaper with water).
- Prime surface using high-grade primer.
- Apply top coat. Use one or two coats as necessary.
- See Section 4, p. 47.

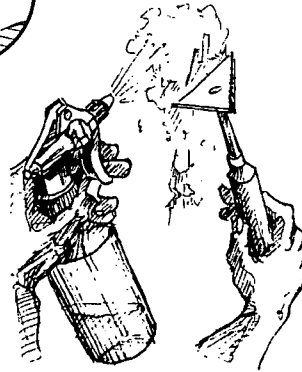
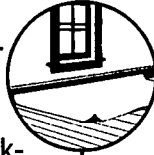

Important: Allow surface to thoroughly dry before priming.



DOING THE WORK

INTERIOR SURFACE PREP CONT'D

PROBLEM

A wall or ceiling has cracking, peeling, or alligating paint, but most of the surface is sound.

SOLUTION

Use a coating designed for longer durability than paint. Some of these coating systems include mesh.

Set Up

- See Section 2, p. 13.



Liquid Coating

Test Surface

- Where a long-lasting system (sometimes called encapsulant) is to be brushed, sprayed, or rolled, surface preparation is very important.
- If an encapsulant is used, use one that is approved by a state government. If your state does not have a list of approved encapsulants, it is recommended that you check with a state that does. Contact the National Lead Information Center at 1-800-424-LEAD for the telephone numbers of states with lists.
- A sample area should be tested before application. Follow manufacturer's instructions exactly.

Apply System Base Coat

- Apply system base coat with a high nap (approximately 3/4 inch) roller. Follow the product instructions.

Mesh System

Apply Mesh

- Where there is extensive cracking or alligating, consider using a system that includes mesh because it can add strength and durability.
- Cut the mesh leaving a 2 inch overlap at ceiling and baseboard.
- Install so that mesh is plumb.



Important: For mesh systems, follow manufacturer's instructions exactly.

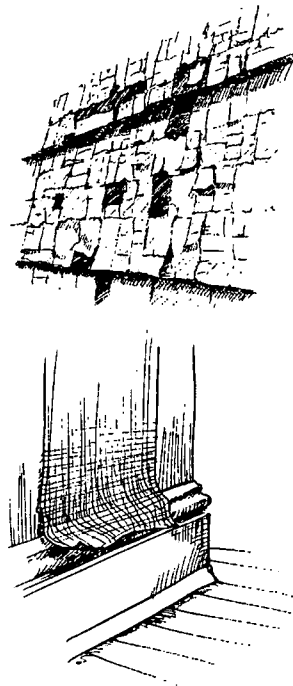

Apply Mesh Cont'd

- Press mesh into the base coat with a wall-paper brush, spackle knife, or roller.
- Overlap seams by 1 inch. Cut down the center of the seam and remove the 2 waste strips. Let seams butt against each other.
- Using a spackle knife, press the mesh at the bottom and top. Then cut off the excess.
- Roll on the top coat. Make sure that there is complete and even coverage.
- If there is a risk of further peeling, the top edge of mesh can be reinforced with cove or crown molding, and the bottom reinforced with base cap.

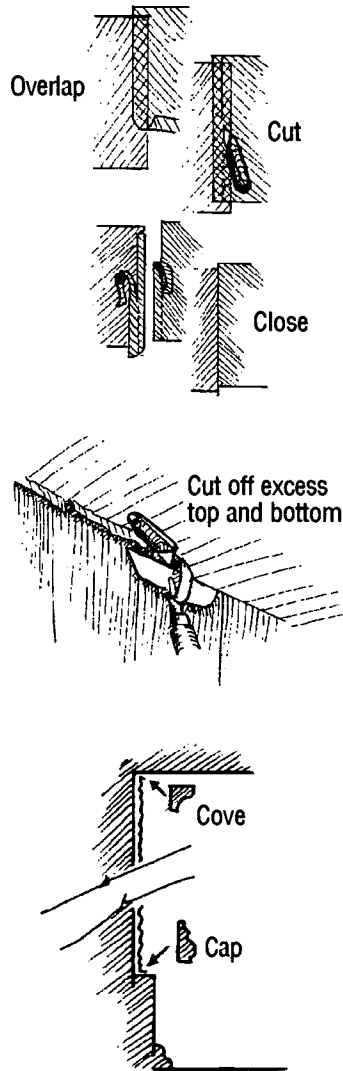

Clean Up and Clear

- See Section 4, p. 47.



DOING THE WORK

EXTERIOR SURFACE PREP

PROBLEM SOLUTION

Exterior wood surface is chipping and peeling and may be painted with lead-based paint.

Prepare a sound, intact surface for painting. Use methods that create minimal dust.

- | | |
|---------------------------|---|
| Set Up | <ul style="list-style-type: none"> • See Section 2, p. 15. |
| Clean Surface | <ul style="list-style-type: none"> • Clean wood with detergent (or lead-specific cleaner) and scrub brush. |
| Wet Scrape | <ul style="list-style-type: none"> • Wet scrape woodwork and siding. Mist small areas frequently to keep down dust. Using a pump sprayer in a knapsack is convenient. |
| Mist and Sand | <ul style="list-style-type: none"> • Wet sand using wet-dry sandpaper or wet sanding sponges. A power sander may be used if attached to a HEPA vacuum, and the worker is wearing respiratory protection. |
| Paint | <ul style="list-style-type: none"> • Prime and paint. |
| Clean Up and Clear | <ul style="list-style-type: none"> • See Section 4, p. 47. |
| Dispose of Water | <ul style="list-style-type: none"> • If you dislodge paint using pressure washing, water must be collected and may need to be tested (see local regulations for water disposal procedures in your area). |

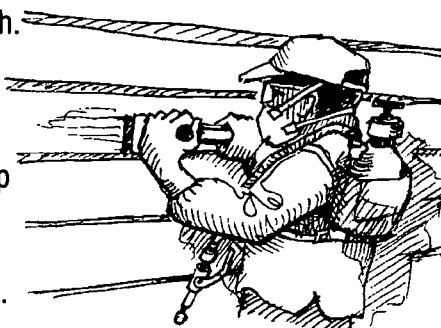

P A I N T R E M O V A L

PROBLEM

Areas of paint are peeling or flaking or there is evidence that a child has been chewing on a painted surface. An example of a surface accessible to children is the inside nose of a window stool (inside sill).

SOLUTION

Remove all paint using methods that do minimum harm to the surface, create minimal dust, and are safe for workers.

Set Up

- See Section 2, p. 13 or p. 15.
- When using chemical strippers, the edge of the protective covering below the painted surface must be tightly fastened to the wall so that the stripper doesn't damage other surfaces.
- Recommendations:
 - Use a second layer of protective sheeting to collect stripping waste. The first layer remains in place to protect surfaces below.
 - For removable components, consider having paint stripped off-site or installing an entirely new component.

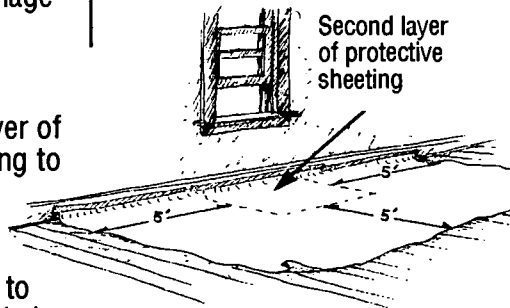
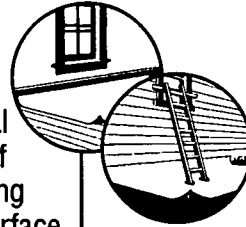

Chemical Removal

- If a large area of paint is to be stripped, consider hiring a professional.
- Follow the manufacturer's instructions carefully when using chemical paint strippers.



Caution: If using a caustic stripper, neutralize the surface according to the manufacturer's directions before applying new paint.

DOING THE WORK

**Chemical Removal
Cont'd**

- After stripping paint from wood, a paint residue will remain in the wood. Use caution when sanding the bare wood because it may contain lead residue.

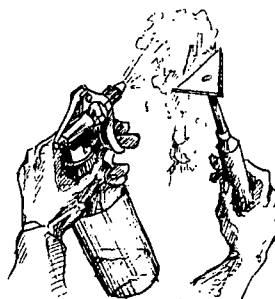

Hand Stripping

- Paint can also be removed with a paint scraper. Be sure to mist areas where paint is to be removed. Using a hand plane removes all paint and all residue. It also creates very little dust.

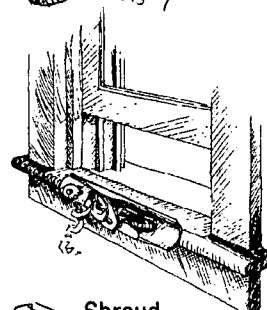

Mechanical Stripping

- When using power tools, such as sanders or grinders to remove or feather paint, make sure the tool is shrouded and attached to a HEPA vacuum. Respiratory protection is still necessary.

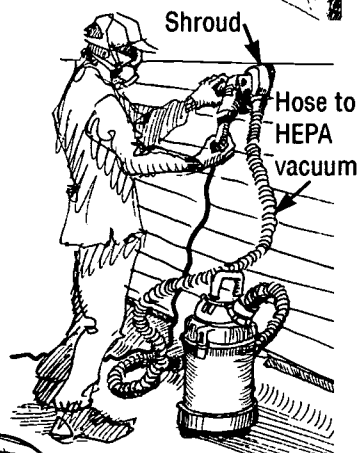

Caution: High dust potential.

Heat Stripping

- When using a heat gun to remove paint, be sure the temperature setting is kept below 1100 degrees F.

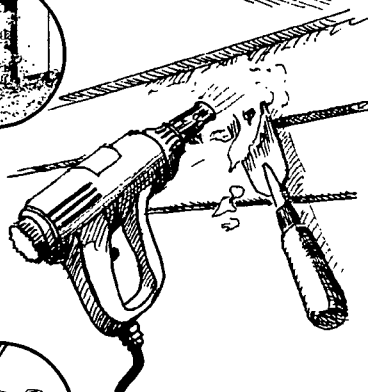

Clean Up and Clear

- See Section 4, p. 47.

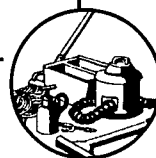

DAMAGED INTERIOR WALL OR CEILING

PROBLEM

Wall or ceiling area is too badly damaged to repair, and demolition would create a large amount of dust.

SOLUTION

Install a new durable surface over the damaged area using methods that create little dust and do not require demolition.

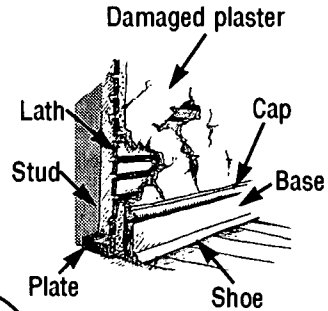

Set Up

- See Section 2, p. 13.

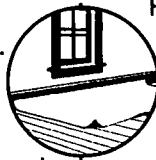

Cover With Drywall

- Mechanically fasten drywall or veneer board through damaged plaster to studs.
- Seal the perimeter, particularly the bottom edge.

Drywall laminate sits on old base

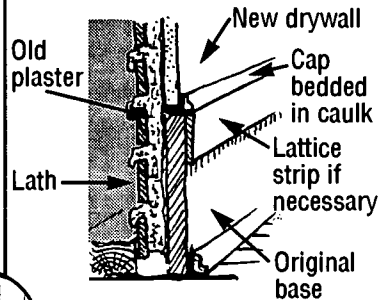

—On Base

- Avoid removing existing base.



Caution: High dust potential.



New base over drywall laminate

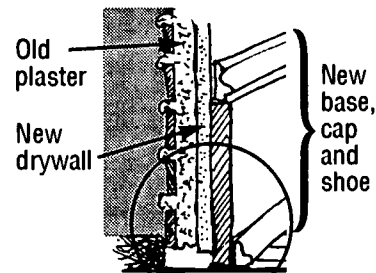

—Behind Base

- Where drywall laminate will end above existing base, install shoe or cove molding into bead of caulk to seal.
- If laminate comes close to flush with base face, a strip of lattice bedded in caulk can be used to seal joint.
- Where base will be replaced, bed the new base in bead of caulk on the back and bottom. Then, bed shoe molding in a bead of caulk to seal.

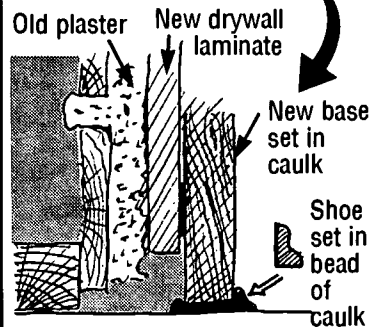

DOING THE WORK

Install Wainscoting

- Where bottom 3 or 4 feet of wall is damaged beyond repair, the wall can be enclosed with wainscoting. The wainscoting can be installed above the existing baseboard.
- Bed the lower edge in a bead of caulk with a trim piece also bedded in caulk.
- Finish top with cap molding.

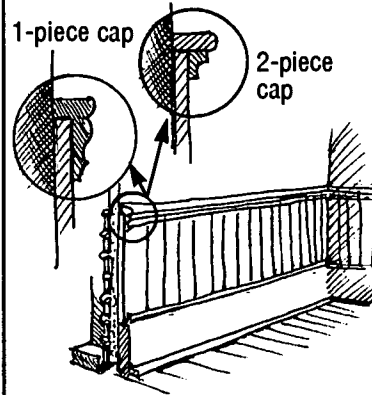

Repair Holes in Ceilings

- When laminating drywall to ceilings, it is critical to screw into joists, not lath.
- Old joists may be irregularly spaced, so each joist center must be located.
- A drywall dagger can be used to find the joist edge, as can a heavy gauge wire pushed through the plaster.
- The drywall edges should be taped and spackled.
- If walls will not be spackled, perimeter edges can be finished with "J" channel bedded in a bead of caulk.

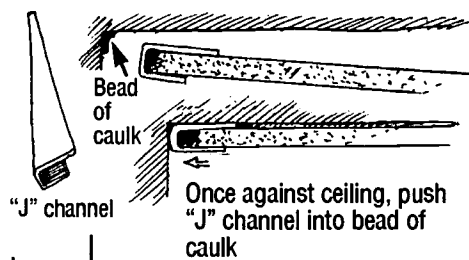
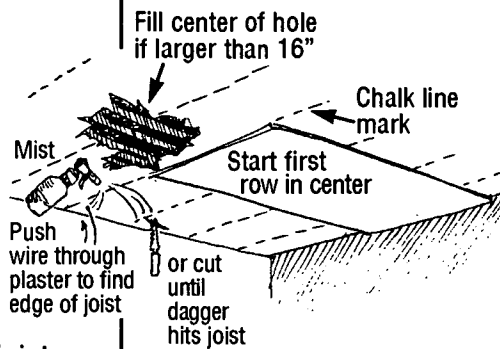

- See Section 4, p. 47.

Clean Up and Clear

DETERIORATED EXTERIOR SURFACES

PROBLEM

An exterior painted surface is badly damaged.

SOLUTION

Whenever possible, repair the surface, prep, prime, and paint exterior trim and siding, and then maintain the surface. This method is the preferred approach.

When a surface is too badly damaged to repair, install vinyl or aluminum siding, or aluminum wrap to create a safe, durable covering that protects the surface and does not cause further deterioration.

Note: Siding must be installed correctly or it may lead to wood rot and/or interior paint failure. Siding may also become home to insects and mold. Correct installation is critical in both hot and cold climates.

Cover Deteriorated Surface With Siding

Set Up

- See Section 2, p. 15.

Install Siding

- Carefully follow the manufacturer's instructions for installing siding over an existing surface.
- Use a styrene backboard with an R-value of at least R2.
- Take care to properly install flashing, especially at horizontal trim and window and door heads.
- The siding system must be well vented but sealed at the bottom to prevent flaking and peeling paint from falling from behind the siding to the ground.
- Be sure that water can drain out.

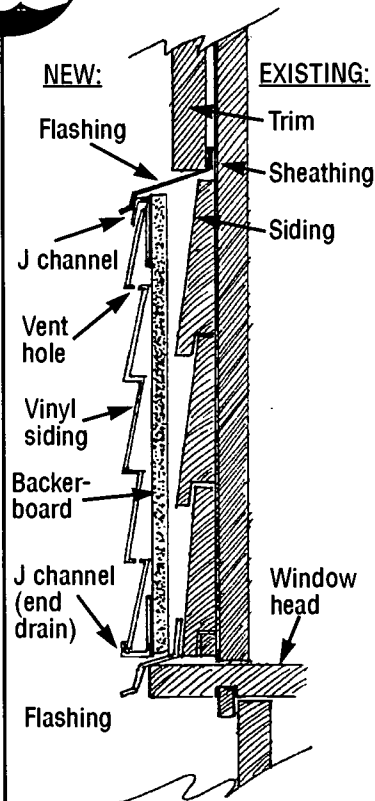
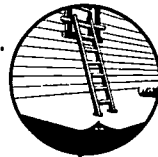

DOING THE WORK



Important: The entire home should be well ventilated to prevent moisture build-up that can cause structural damage and/or paint failure.

**Clean Up
and Clear**

- See Section 4, p. 47.



STICKING WINDOW

SOLUTION

Window sticks, and paint on window is flaking.

Remove window, scrape or plane, repaint, and reinstall, OR install a new window.

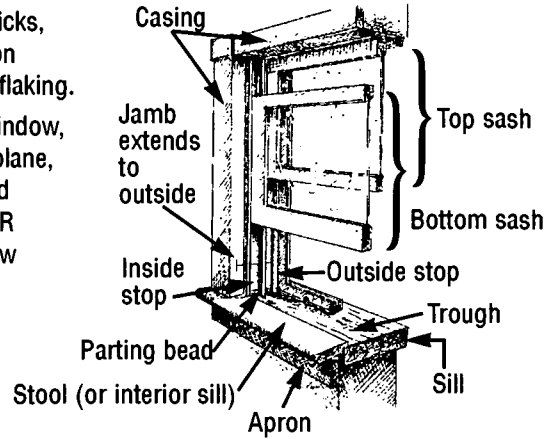

Set Up

- See Section 2, p. 13.

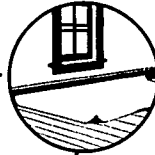

Loosen Painted Sashes

- If window is painted shut, mist and cut window joint with utility knife. Then open joint between sash and stop with a "window opener." Mist while working.

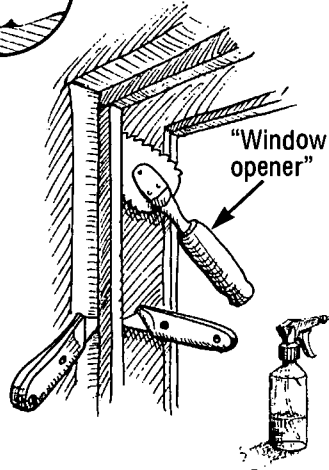

Remove Inside Stop Molding

- Mist and remove stop molding from sides and head. Dispose of properly unless it has historic value.

Remove Bottom Sash

- If counterweight cord or chain is attached to the sash, knot it or tie it to a stick when removing from sash so it does not get pulled into the weight compartment.



DOING THE WORK

Remove Top Sash

- Mist and remove parting bead. Then remove the top sash.

Wet Scrape or Plane

- Set sash on a work bench, clamp, and wet scrape all surfaces. Or use a power planer attached to a HEPA vacuum.



Caution: High dust potential. This work can be done in a dust room. See Section 5D: Setting Up a Dust Room, p. 73.

Wet scrape these ridges of paint

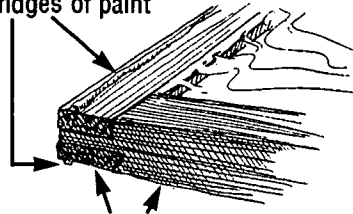

Seal this bottom edge very well, particularly the end grain. Use linseed oil or other sealant.

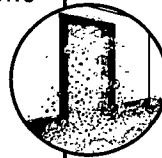

Repair, Reglaze, Seal, and Paint

- Reglaze and repair as necessary. Wet sand, prime, and paint sash and jamb. Seal, but do not paint sash edges.



Important: Seal bottom edge of sash, particularly end grain.

Repair and Paint Jamb

- Repair jamb if necessary.
- To prevent dust and chips from falling outside the window, install a scoop of protective sheeting.
- Then wet scrape, prime, and paint.

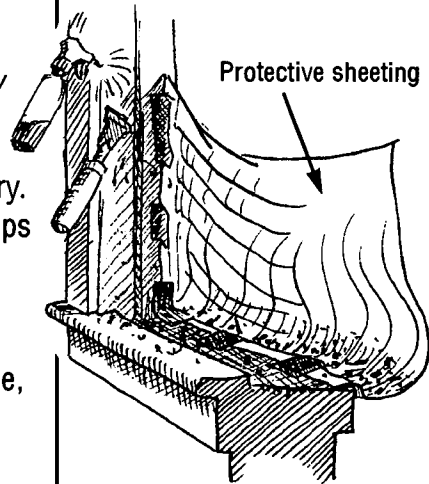

Reinstall Sash

- Reinstall sash with new or wet scraped and repainted stop and parting bead.

Clean Up and Clear

- See Section 4, p. 47.

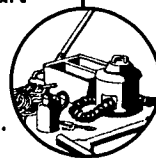

LOOSE WINDOW



Loose sashes (lower and upper) do not operate smoothly, and they allow heat loss. Also, sashes rubbing against a painted jamb create paint dust.

SOLUTION

Install sashes in window compression jamb liner to seal window and allow sashes to move easily without rubbing against jamb. If sashes or window components are badly deteriorated, replace window.

Set Up

- See Section 2, p. 13.

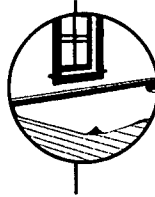

Install Window Jamb Liners

Remove Sashes and Paint

- Follow directions on pages 29 and 30.

Cut Jamb Liners

- Cut liners to fit in jamb (1/4 inch short of dimension). If pulley system is being saved, cut off directly below pulley.

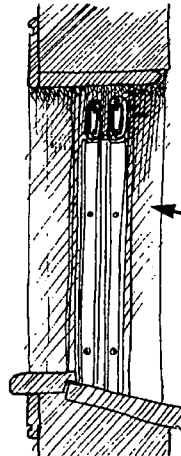

Window jamb liner installed below pulleys to keep counterweight system working

Install Jamb Liners

- Press jamb liners onto sash.
- Attach jamb liners with brass screws on top and bottom of each side.

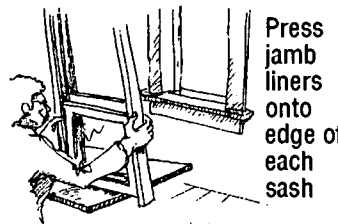

Press jamb liners onto edge of each sash

Slide sashes and liners into jamb and put two brass screws into each side

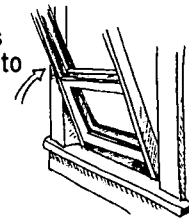

DOING THE WORK

Install Stop Molding

- Install new inside stop molding tight against jamb liner.

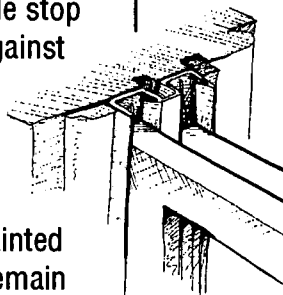

- If top sash is painted shut and is to remain fixed, adjust the above steps as follows:
 - Cut away flange between channels of jamb liner.
 - Leave parting bead intact and install bottom sash as above.

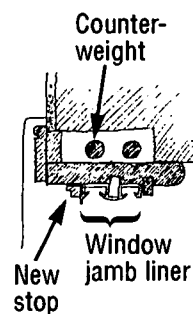

Cut flange of jamb liner with plexiglass cutter.

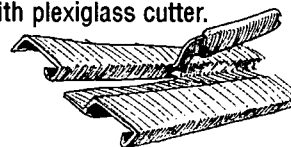

Replace Sash/Window

Choose an Option

- If the sashes or other components are too badly deteriorated to save, consider one of the following options:
 - Install new sashes in tilt-in jamb liners.
 - Replace sashes, stops, and parting bead with a vinyl or aluminum window unit.
 - Replace entire window including jamb casing, stool, and apron.

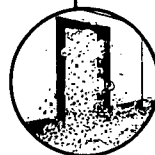

Clean Up and Clear

- See Section 4, p. 47.



WINDOW WON'T STAY OPEN

PROBLEM

Window sash is loose and won't stay up without support. Propping the window open presents a danger to occupants, particularly children. When a window jamb liner is used, it may not be sufficient to keep the window open. (See page 31.)

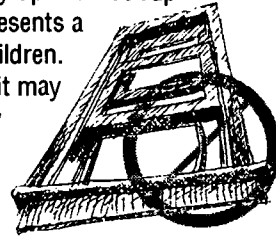

SOLUTION

Repair counterweight system or install hardware so the window will stay open securely, or replace window.

Set Up

- See Section 2, p. 13.



Option #1: Reinstall Counterweight System

Open Counterweight Panel

- Find top of panel. Mist and scrape paint from top edge to find screw or nail holding in panel. Remove screw and pry off panel.

Vacuum

- Vacuum weight compartment with HEPA vacuum.

Remove Counterweight System

- Remove old rope or chain from counterweight and edge of sash.

Reinstall Counterweight System

- Cut chain so weight is above bottom of weight compartment when open and weight is below pulley when closed.

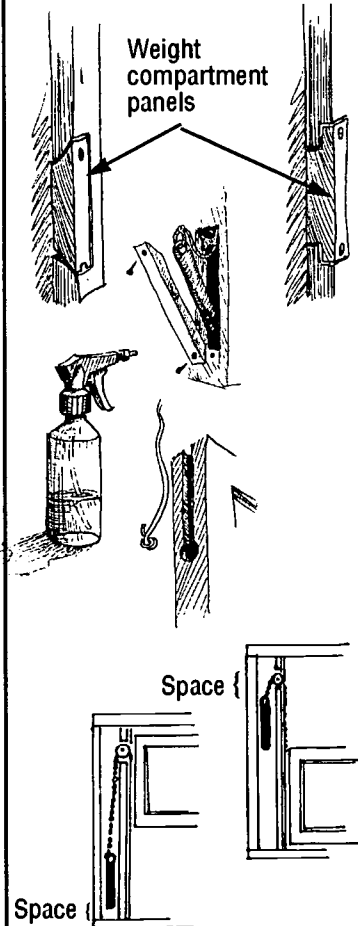

DOING THE WORK

Reinstall Counter Weight System Cont'd

- Drop chain over pulley into weight compartment, pull out through panel opening, and attach to weight.
- Attach other end to edge of window sash using spring fixture. You may want to secure chain with fence staple.

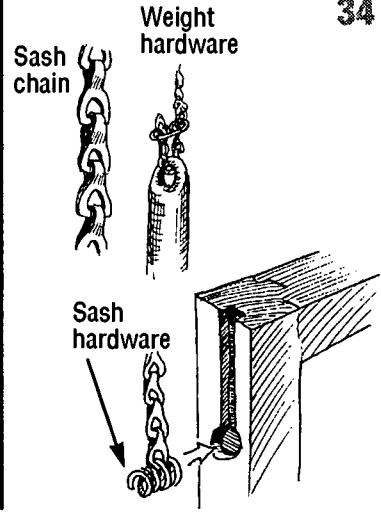

Option #2: Install Spring Clips

Install Spring Clips

- Screw spring clips on to window as directions indicate. (2 styles shown.)

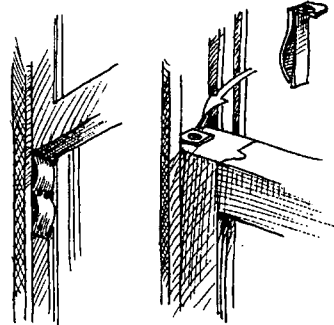

Option #3: Install "Hold Open" Hardware

Install Slide Bolt

- Screw slide bolt to bottom of window sash. Tap bolt to mark where you want to drill holes for bolt. Drill holes in inside stop at 3 or 4 points.

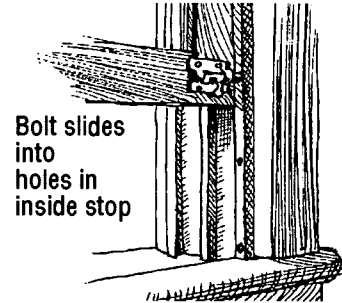

OR

Attach Hardware

- Attach hardware that uses spring to press against stop. To move sash, press lever. Release lever when window is at desired height.



Clean Up and Clear

- See Section 4, p. 47.



DETERIORATED WINDOW TROUGH

PROBLEM

Storm window traps water behind the frame causing paint deterioration and damage to the sill.

BEFORE

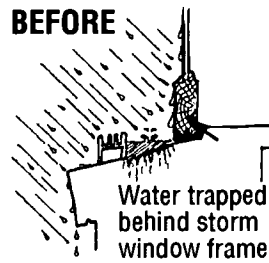

SOLUTION

Drill a drain hole through bottom of the storm window frame.

PROBLEM

Window trough surface is damaged and difficult to clean.

SOLUTION

Install smooth and cleanable surface in window trough.

AFTER

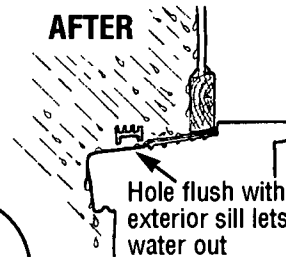

Set Up

- See Section 2, p. 13.

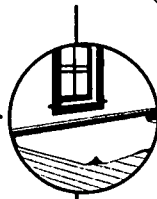

Drill Drain Hole

Drill

- To allow drainage, drill 2 holes through frame of storm window flush with sill. Drill holes approximately one quarter of the way from both sides. First, drill a 1/8 inch pilot hole, then the 3/8 inch hole.

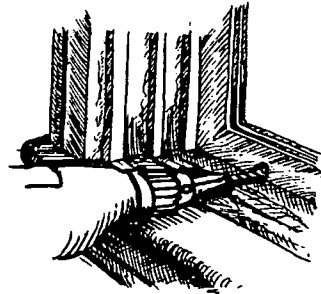

Dent

- If flashing is installed in window trough and covers any part of the drain hole, run awl through drain hole. Tap with hammer to form dent in flashing to drain out water.

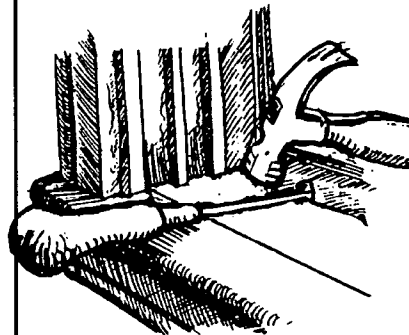

DOING THE WORK

Cover Trough with Flashing

Wet Scrape

- To make surface flat, wet scrape high points and remove any fasteners from trough.

Cut

- Cut flashing 1/4 inch shorter than the width and length of trough.

Chisel or Notch

- To allow flashing to fit tight to jamb, drive chisel under parting bead and outside stop — or notch each side of the flashing at these two points.

Check Fit

- Then slide flashing in to check fit. Remove and trim if needed.

Fasten

- To fasten flashing, run bead of adhesive caulk around perimeter of trough.

Install Flashing

- Bed flashing in adhesive caulk bead and press down.

Seal

- Run a bead of caulk around perimeter of flashing. If necessary wipe off excess caulk with damp cloth. Try not to smear caulk on face of flashing.



Important: Do not cover drain hole with caulk.

Clean Up and Clear

- See Section 4, p. 47.

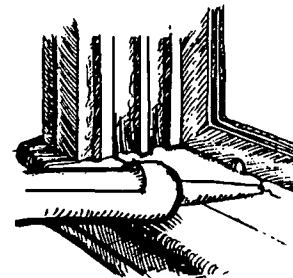
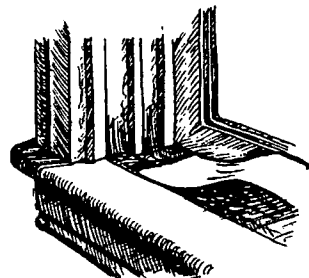
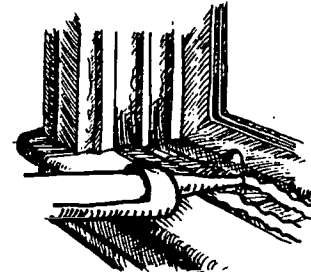
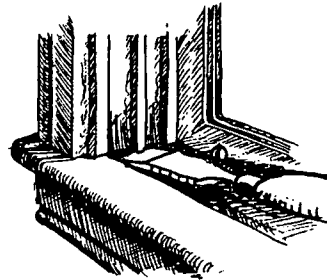
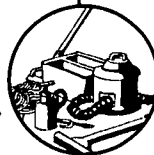

DOOR NEEDS ADJUSTMENT



Edge of door is crushing against jamb on hinge side; or door is rubbing on latch side because hinges are loose. When paint on a door rubs or is crushed, dust and paint chips can result.

SOLUTION

Adjust the door so that it opens and closes without damaging painted surfaces.

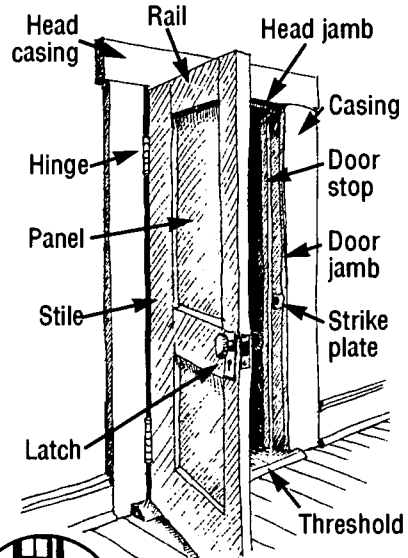

Set Up

- See Section 2, p. 13.

Check Door

- Grasp knob and try to move door up and down. If hinges are loose, door will move.

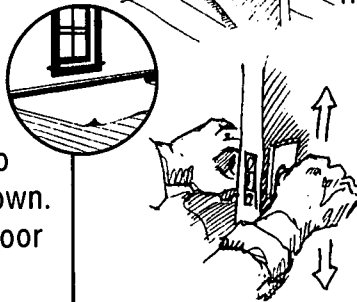

Remove Screws

- Remove screws that are most loose, but not all screws, so door remains hung.
 - Clear paint from screw notch with hammer and small screwdriver.
 - Unscrew. If screw head is stripped, use screwdriver bit in a brace.

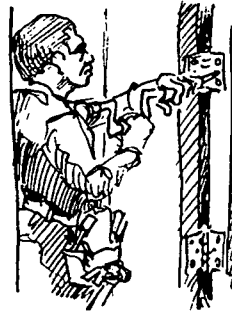

Fill Hole

- Drive 3/16 inch or 1/4 inch dowel into screw holes as necessary to fill each hole. Cut dowels flush.

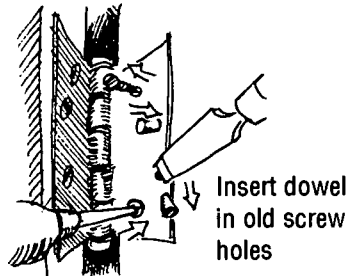

DOING THE WORK

Install New Screws

- Replace screws. Use longer screws if necessary. Using a screwdriver bit on a brace makes this easier. Then remove and replace remaining screws as necessary.

Adjust Stop

- Face of door should only contact the stop on the latch side of door frame. It should not crush or rub head or hinge side stop.
- Where stop is nailed, remove and replace with new matching stop. Leave 1/8 inch space between hinge, head stop, and the face of the door.

Check Clearance

- If putty knife can't fit in gap between door and jamb at all points, crushing of painted surfaces may be occurring.

Adjust Depth of Hinge Leaf

- If door is crushing hinge side and there is more clearance than necessary on the latch side, install metal shims behind hinge leaves. Keep at least 1/8 inch clearance on leaf side and 1/8 inch clearance on latch side. If not enough clearance, see p. 39.
- If only a small increase is needed between leaves of hinge to create a gap between door edge and jamb, place a steel rod between hinge leaves near pin and close door to slightly bend apart leaves.

Clean Up and Clear

- See Section 4, p. 47.

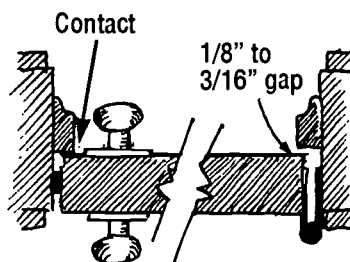

Check perimeter of door for clearance of 1/8" to 3/16"

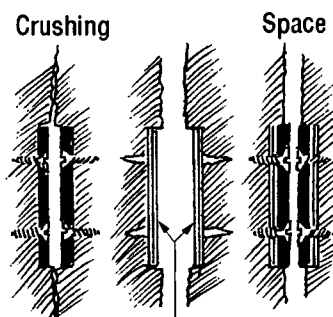
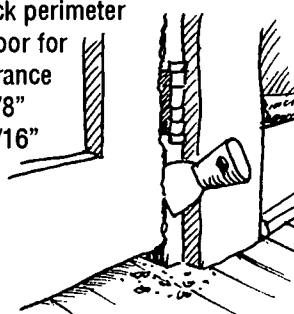

Add shim stock

Use steel rod (like screwdriver) to bend open hinge

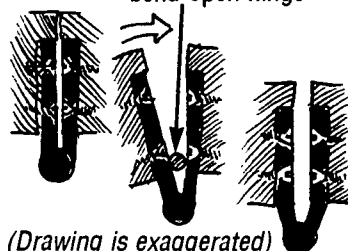

(Drawing is exaggerated)



DOOR RUBS OR STICKS



Door is scraping on latch side; or door is crushing jamb on latch side and there is not enough clearance on latch side to add shims to hinges. When paint on a door rubs or is crushed, paint chips can result.

SOLUTION

Plane edges of door so that it operates smoothly and does not rub.

- Set Up**
- Remove Hinge Leaves**
- Hand Plane Edge**
- Recut Gains**
- Seal Edges**
- Clean Up and Clear**

- See Section 2, p. 13.
- Remove pins from hinges and hinge leaves from door.
- Set door on edge in a door hold. (See Section 5: Building a Door Hold, p. 74.)
- Mist surface and hand plane a chamfer edge.
- Use a smooth bench or jointer plane (not a block plane) to remove the rest of the paint from the edge. Continue to mist while working. If a power planer is used to remove paint, it must be attached to a HEPA vacuum. Some power planers need an adaptor to accept HEPA attachments.
- Once paint is removed, use either a hand or power planer.
- Then, recut gains as necessary so hinge leaf is set about halfway into gain.
- Seal edges of door, particularly the bottom, and rehang.
- See Section 4, p. 47.

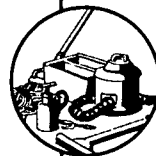
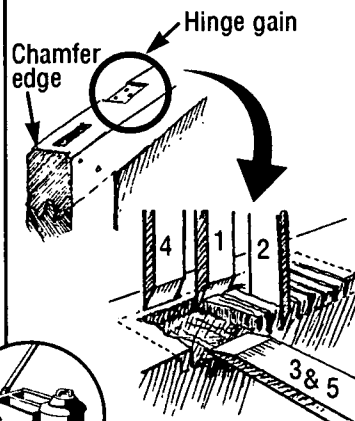
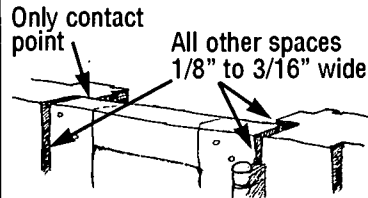
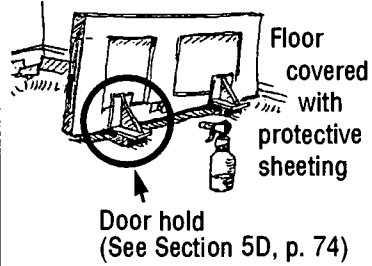

DOING THE WORK

CHIPPING PAINT ON STAIRS OR FLOOR



Painted staircase treads, risers or floors are worn, or the paint is chipping. Paint and other coatings used on staircases and floors in older homes often contain lead. Everyday friction and wear can produce paint chips and dust.

SOLUTION

Cover portions of stairs or floor that are worn with durable material.

Set Up

- See Section 2, p. 13.

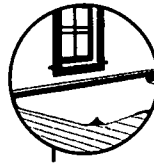

Stairs – Option #1: Install Tread Covers and Riser Enclosures

Wet Scrape

- Mist and wet scrape any loose paint on treads and risers, particularly on edges.

Prime and Paint

- Prime treads and risers. Paint edges that will not be covered by enclosures.

Install Riser Enclosure

- Cut 1/4 inch lauan plywood to fit each riser. Sand exposed edges of lauan.

Fasten

- Back caulk perimeter of riser with adhesive caulk. Press tight or nail with finish nails.

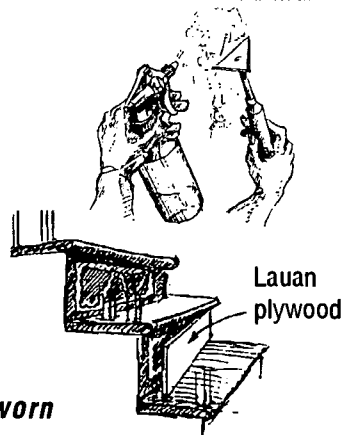
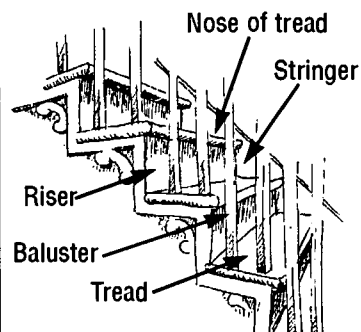

If nose tread is not worn

Cut and Install Tread Cover

- Cut cover to fit over the tread and nose.
- Install cover with adhesive caulk or screws.

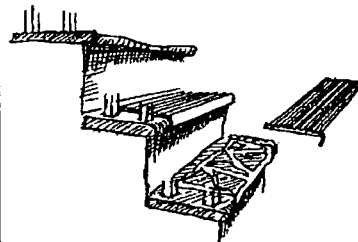

DOING THE WORK

If nose tread is worn

PROBLEM

Installing a rubber tread over a worn tread nose creates a hollow space under the rubber tread cover. This can cause the rubber tread cover to tear, posing a tripping hazard.

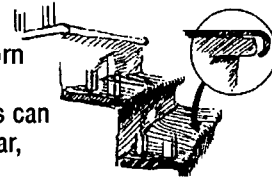

Cut and Install Tread Cover

- Cut tread cover to fit from the riser to rear edge of nose. Install with adhesive caulk or screws.

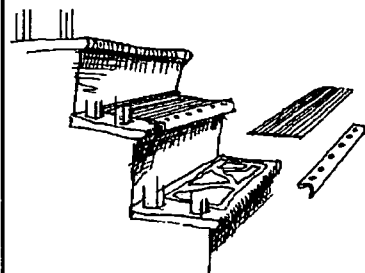

Install Metal Nose Cover

- Screw metal cover over edge of tread nose. It will span the worn area of the nose.

Stairs – Option #2: Install Staircase Runner

Wet Scrape

- Mist and wet scrape any loose paint on tread and riser, particularly on edges.

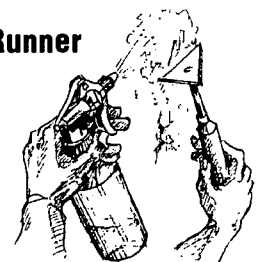

Prime and Paint

- Prime and paint treads and risers.

Install Runner

- Staple runner to top of top riser. Then fasten with staircase bars so runner may be easily removed for cleaning.

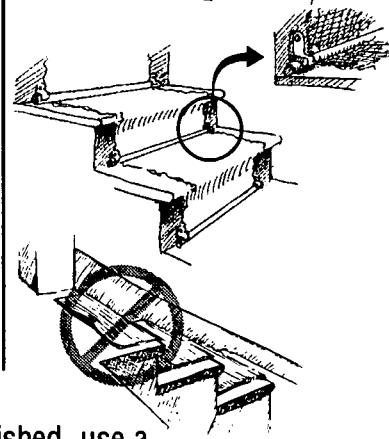

Important: Do not install runner or tread cover on landing of upper floor where its rear edge may become a tripping hazard.

Floors

Prep Surface

- If a floor needs to be refinished, use a floor sander attached to a HEPA vacuum.



Cover

Caution: High dust potential.

- Apply a coating to the floor to keep it smooth and cleanable.
- To maintain a smooth and cleanable surface, it is recommended that the use of wall-to-wall carpeting be avoided. Area rugs can be used instead.

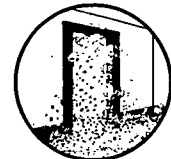

Clean Up and Clear

- See Section 4, p. 47.



CHIPPED OR DAMAGED IMPACT SURFACES

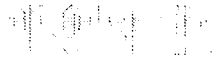

Outside corners of walls, edges at passages, as well as trim, base cap, and shoe molding are being chipped due to impact from doors, furniture, and other objects. If these surfaces are covered with lead-based paint, the paint chips and the dust created may pose a health threat.

SOLUTION

Protecting these surfaces with a durable material can prevent the creation of paint chips and dust.

Set Up

- See Section 2, p. 13.

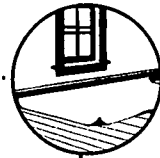

Enclose Outside Corner

- Cover outside corners of walls with corner molding. Attach with nails and/or with a bead of adhesive.

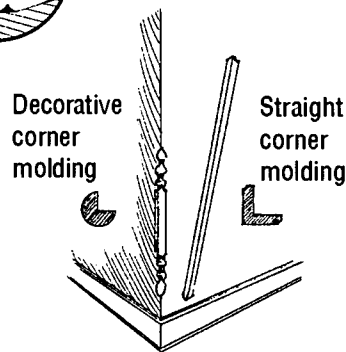

Protect Base

- In places where a baseboard shows signs of impact, replace shoe and protect cap with lattice strip.
- When replacing shoe, bed new shoe in bead of caulk to seal out moisture and prevent infiltration of dust.

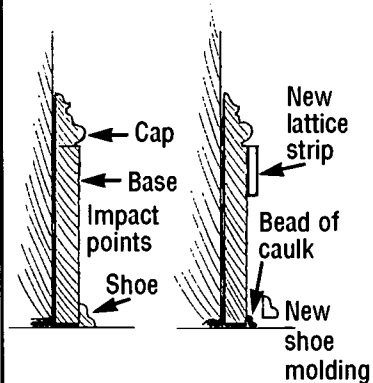

Clean Up and Clear

- See Section 4, p. 47.

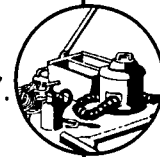

DOING THE WORK

H I G H D U S T J O B S

Some jobs create large amounts of dust. To be safe, workers doing this type of work should:

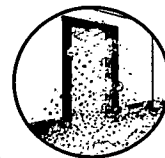

1. Wear half-mask respirators rated by NIOSH as N100 (or HEPA) at a minimum and be trained to wear and maintain them, or conduct air monitoring to show that they are not needed. (See Section 5D: Respiratory Protection, p. 69.)
2. Completely isolate the work space from occupied spaces and use containment to protect other workers. (See next page.)
3. Receive lead worker or supervisor training from an accredited trainer. In most states, accredited courses are available. To locate a course in your state, contact the Leadlisting at 1-888-Leadlist (1-888-532-3547) or www.leadlisting.org.



Remember: All house dust is unhealthy to breathe. It may contain lead, mold, asbestos, gypsum, roach waste, dust mites, coal dust, fiberglass, etc.

Examples of High Dust Jobs

The following types of work are likely to create high levels of dust:

Demolition. Demolition includes tearing off siding and/or demolishing old plaster walls or ceilings.

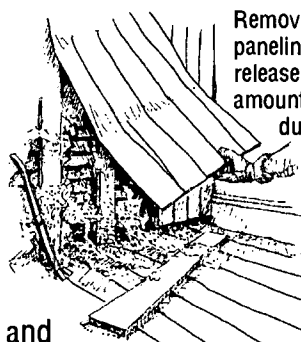

Removing old paneling can release large amounts of dust.

Opening Up Wall Cavities. These jobs include:

- Removing old paneling and baseboards
- Removing door casings and frames or window casings or jambs

"It's not just what's on the wall, it's the dust behind it."

Removing Old Drop Ceilings. Lots of dust can accumulate above ceiling panels.

Improperly Removing Wall-To-Wall Carpet. A carpet that's been on the floor for many years has gathered large amounts of household dust, which may include lead dust. Improperly removing it can release a large amount of dust.

DOING THE WORK

Paint Scraping. Scraping large painted areas, such as the side of a house or an entire room, even when done correctly, can create a large amount of dust.

Containing Dust

Use this system to keep dust from spreading to another room.

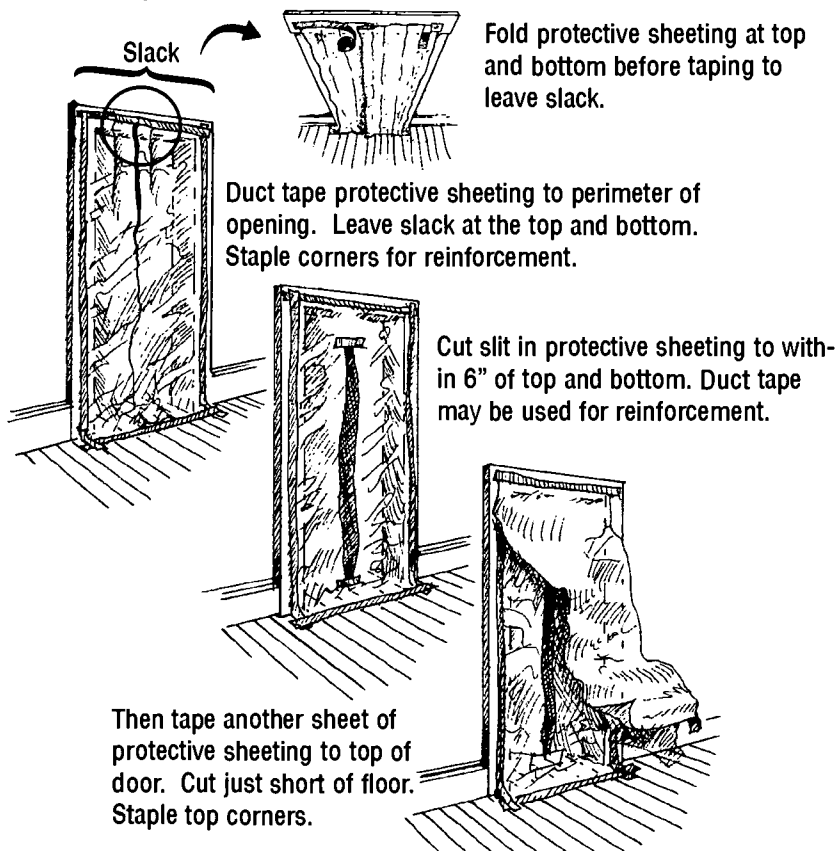

If a job creates extremely high amounts of dust (for example, demolition) or large amounts of dust in the air for more than short periods, the protective flap system shown above may not be sufficient to prevent dust from spreading beyond the work area.

For these types of jobs, a more protective system called "isolation" is needed so that dust does not spread beyond the work area. Isolation means that the work area is sealed with no direct access to occupied areas of the home. Workers need to use an entrance that is separate from occupants until cleanup is completed.

C L E A N I N G U P

It is very important to use proper cleanup procedures at the end of the job. Dust and paint chips left behind at the end of the job may contain lead and may endanger children. Have dust wipe samples collected at the end of the job to be sure that it is safe for children to return.

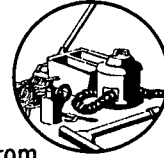

Pick Up Work Area

- Pick up large chips with damp paper towel.
- AND/OR**
- Mist then push dust into dust pan.

Make dust pan from flashing and clean with a whisk broom.

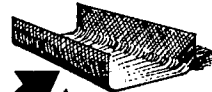

Pick Up Protective Sheeting

- Clean off protective sheeting. Fold dirty side inward (dirty side to dirty side). Dispose of protective sheeting at the end of each job. Protective sheeting may be used again within the same work area if it has not already been folded.

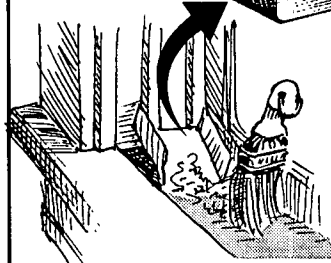

Mist and push dust



Vacuum

- HEPA vacuum all horizontal surfaces—slowly.
- Vacuum all ledges, sills, stools, molding tops, dusty surfaces, etc.
- Vacuum floor under work area. Use corner tool in corners, cracks of trim, and between floor boards.
- Vacuum floor with floor brush and carpet with a carpet tool.

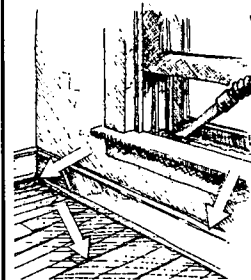

Vacuuming the cracks is very important.



Mist and Scrub

Important: Vacuum carpet very slowly.

- Wet rag with detergent then wring out.
- Mist surface or rag as you clean.
- Lead needs scrubbing, not just wiping.

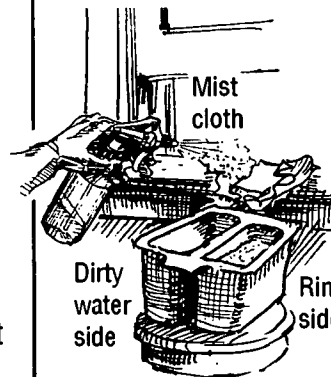

Mist cloth

Dirty water side

Rinse side

AT THE END OF THE JOB

Rinse Rag

- Squeeze rag into empty side of split bucket. Rinse out rag. Squeeze into empty side. Repeat as needed.
- Change rinse water often.
 - Use paper towels first if surfaces are very dirty.
 - Replace rag when it looks dirty.
- Clean until dust and debris are removed.

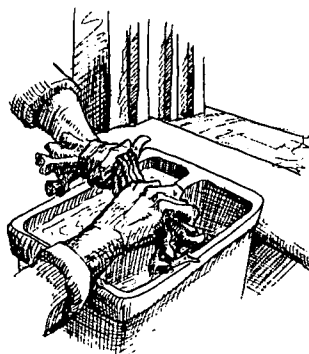

Cleaning Floors

Mist and Scrub

- At start of cleaning, soak mop in detergent water then mist small area with detergent before mopping.
- Scrub with mop.

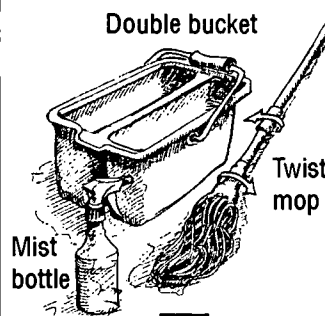

Squeeze Out and Wash

- Squeeze mop into empty bucket then rinse in rinse water. Rinse often. Squeeze out and rinse again. Mop small areas at a time.

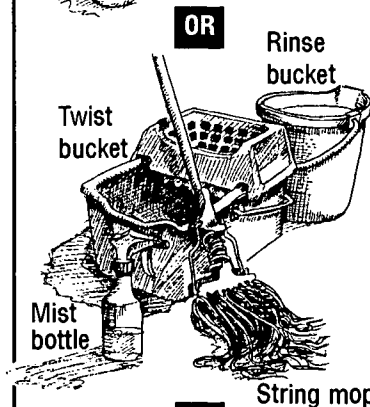

Rinse

- Repeat above process using clean water rather than detergent. When cleaning up a work site, use a new mop head for rinse stage.

Recommendation: Make a final pass with a HEPA vacuum.

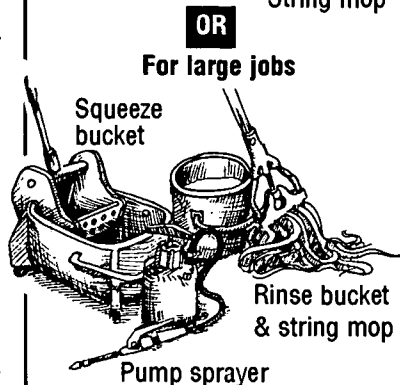

Dispose of Waste

- See following section.

Take Dust Wipe Sample

- See Section 5D: Testing Dust for Lead, p. 71.

DISPOSAL OF WASTE

After cleanup of the work area, take care to safely handle and remove dust and debris from the job. Supervisors should check with the EPA and their state's agency responsible for waste to find out about specific Federal, state, and local regulations regarding disposal of waste that may contain lead-based paint.

Key Principle:

Confine dust and waste to the work area that will be cleaned.

Disposal Practices

Specific guidelines are:

- Avoid carrying construction waste through an occupied space. If you must carry it through an occupied space, first place it in a heavy duty plastic bag or wrap it in protective sheeting and seal with tape.
- When a dumpster is used, keep the dumpster covered. If a chute is used, cover the chute (or use a barrel chute) and cover the dumpster.
- Store all waste in a secure container or dumpster until disposal. Do not transport waste in an open truck, unless it is bagged and sealed.

Water

Water used for clean up should be dumped into a toilet. Never dump this water in a sink, tub, on the ground, or down a storm drain.

Water used to remove paint through pressure washing must be collected in drums and may need to be tested to determine if it is hazardous. Check with your state agency responsible for waste.

AT THE END OF THE JOB

4

49

CHECK YOUR WORK!

Check Quality of Work & Cleanup

Check work quality **during the job** and at the **end of the job**.

- **Was the cause of the problem corrected?**
- **Were proper work practices used?**
- **Was cleanup done thoroughly?**

How to Check:

Checking your work involves two important steps.

1. Visual Checks

Use the checklist inside the back cover of this guide when performing visual checks.

- **During the Job.** Be sure that:
 - the cause of the problem is being corrected;
 - the work area is safely set up;
 - the practices in this guide are being used; and
 - dust and debris are not spreading beyond the work area.
- **End of the Job.** Be sure that the repairs were done properly and that no dust or paint chips remain.

2. Take a Dust Wipe Sample

When interior work disturbs painted surfaces or produces dust, have dust wipe samples taken at the end of the job to check for harmful levels of lead-contaminated dust.

To be accurate, these tests must be done according to specific procedures. See Section 5D, p. 71, for more information about these tests, and who should perform them.

AT THE END OF THE JOB

4

51

**How to
Check
Cont'd**

Dust wipe testing is recommended at the end of any job that disturbs paint or produces dust. It is **strongly recommended** when:

- Work that disturbs paint is done in homes built before 1978.
- A young child or pregnant woman lives in the home.
- Performing unit turnover or regular maintenance in rental properties.

**Why Is It
Important
to Check
Work?**

Checking that work was done properly is important because:

- Failing to correct conditions causing damage or deterioration results in repairs that do not last.
- Work that fails to follow the recommendations in this guide may spread dust and paint chips beyond the work area and may endanger children in the home.
- Dust and paint chips left behind due to poor cleaning may contain lead and may also endanger children in the home.
- For contractors, checking your work improves the quality of a job and is likely to reduce the risk of a lawsuit in the event a child in the home is later found to have high levels of lead in his/her blood.
- Leaving a clean job site is greatly appreciated by customers.

ONGOING MONITORING & MAINTENANCE

Regularly Check Repairs for Deterioration, Paint Chips, and Dust

Property owners should regularly monitor painted surfaces where maintenance or improvements were performed.

Check to see if:

- New evidence of deterioration or paint failure is present.
- The cause of the problem was corrected.
- Lead dust hazards are present. *Important: This can only be done by dust wipe sampling.*

Maintain Surfaces and Thoroughly Clean

Then:

- Perform repairs, as needed, to maintain surfaces in a smooth and cleanable condition using the methods recommended in this guide; and
- Clean the area thoroughly using the practices described earlier in this section.

Methods of Monitoring

Follow the same methods used to check your work:

- **Visual Check.** Look for deterioration, paint failure, dust and paint chips. Use the checklist inside the back cover of this guide.
- **Test for Lead Dust.** Have dust wipe samples taken to check for dust that may be contaminated with lead. A test is needed to determine when dust contains harmful amounts of lead.

To be accurate, these tests must be done according to specific procedures. See Section 5D, p. 71, for more information about these tests, and who should perform them.

When to Monitor?

- **Annually.** Perform a visual check of past repairs and improvements involving painted surfaces.
- **During Unit Turnover or Routine Maintenance.** Perform a visual check of past repairs and improvements involving painted surfaces.
- **Every Two Years.** Get a dust wipe test done at least every two years. This type of test is **strongly recommended** when a young child or pregnant woman lives in the home.

AT THE END OF THE JOB

**Why Is It
Important to
Monitor &
Maintain
Work?**

Monitoring and maintenance helps:

- Plan and implement maintenance tasks
- Protect occupants and neighbors, particularly children, from lead exposure
- Give owners, contractors, and residents a record of the condition of the unit

A - G L O S S A R Y

Aluminum flashing - thin aluminum sheeting, also known as coil stock.

Aviation snips - metal cutters.

Chamfer - a small bevel on an edge.

Enclosure - a rigid, durable construction material that is mechanically fastened to the structure to cover painted surfaces.

Fit testing - a method to check if a respirator fits properly over the face.

Gain - notch chiseled in a door for a hinge leaf.

HEPA filter - High-Efficiency Particulate Air filter. A filter that can remove particles of 0.3 micrometers or larger from the air at 99.97 percent or greater efficiency.

HEPA vacuum - a vacuum with a HEPA filter.

HUD Guidelines - HUD's *Guidelines for the Evaluation and Control of Lead-Based Paint Hazards in Housing*.

Interim controls - a set of measures to reduce exposure to lead hazards. Interim control measures include special cleaning, repairs, paint stabilization, enclosure, and containment. For a full discussion, see HUD's *Guidelines for the Evaluation and Control of Lead-Based Paint Hazards in Housing*.

Lauan plywood - 1/4 inch plywood made of lauan with a smooth face.

N100 - a NIOSH filter class that describes a respirator's ability to filter airborne particles. A respirator filter rated as N100 removes particles of 0.3 microns or larger from the air at 99.97 percent or greater efficiency.

NIOSH - National Institute for Occupational Safety and Health, an agency within the Centers for Disease Control and Prevention that tests and certifies safety equipment including respirators.

RESOURCES

5

55

OSHA - Occupational Safety and Health Administration, an agency of the U.S. Department of Labor that oversees worker safety.

Paint stabilization - a process of wet scraping, priming, and finish coating of a deteriorated painted surface to prevent further deterioration.

Permissible Exposure Limit (PEL) - a dust exposure threshold set by OSHA. Work that creates lead dust levels in the air greater than the PEL must meet OSHA lead safety requirements for workers. OSHA has set the PEL for airborne lead dust at 50 micrograms per cubic meter ($\mu\text{g}/\text{m}^3$) as a time weighted average. See Section 5D, p. 69, for technical information about OSHA requirements and Section 5B, p. 61, for information about OSHA regulations.

Pilot hole - a small hole drilled to guide the drilling of a larger hole.

Protective sheeting - made of plastic, poly or other material. Protective sheeting must be puncture and tear resistant, impermeable to liquids, durable, flexible, and lightweight.

R-value - a measure of heat containment; used for rating insulation effectiveness.

Shim - small piece of wood or metal used to fill space between two fastened components.

Shroud - a protective covering that contains dust and chips.

Substrate - a solid surface such as plaster, drywall, wood, etc.

Tack pad - a sticky pad that helps remove dust from shoes.

Window trough - the area of the sill between a window stool or interior sill and the frame of the storm window where the bottom sash rests when closed (also called a window well or exterior sill).

B. FOR MORE INFORMATION

This section lists useful documents, web sites, and other lead-based paint information resources. Additional sources also exist. Use the reference letter on the right to locate the contact for each information resource. Contacts are listed by letter on pages 62-64. Publications marked with an * are for sale; others are available for free.

Where can I get more information on...

Work practices and lead-safety?

Publications	Reference Letter
<ul style="list-style-type: none"> • <i>Guidelines for the Evaluation and Control of Lead-Based Paint Hazards in Housing (July 1995).</i>* Technical guidance on methods for identifying and controlling lead-based paint and lead-based paint hazards. The <i>Guidelines</i> can also be downloaded for free from the HUD Office of Lead Hazard Control web site. (About 750 pages) 	B, C
<ul style="list-style-type: none"> • <i>Residential Lead Desktop Reference (2nd Edition, June 1998).</i>* A CD-ROM containing a large variety of lead-based paint information resources. 	C
<ul style="list-style-type: none"> • <i>Maintaining a Lead Safe Home (1997).</i>* A do-it-yourself manual for homeowners and property managers. (89 pages) 	B
<ul style="list-style-type: none"> • <i>Lead-Based Paint: Operations and Maintenance Work Practices Manual for Homes and Buildings (May 1995).</i>* Technical guidance on safe work practices. (200 pages) 	G
<ul style="list-style-type: none"> • <i>Guide Specifications for Reducing Lead-Based Paint Hazards (May 1995).</i>* Technical guidance on purchasing lead-hazard control reduction services and developing lead-hazard reduction work specifications. (About 500 pages) 	G
<ul style="list-style-type: none"> • <i>Lead Safety for Nonprofit Property Owners, Developers, and Managers (July 1998).</i> Practical guide to developing policies and activities that incorporate lead safety in property management. (About 30 pages) 	F

RESOURCES

5

57

**Reference
Letter**
Publications

- *Guide to Working Safely with Residential Lead Paint (1999)*. Pamphlet with key lead safety precautions to follow during repainting and home improvement.
- *Reducing Lead Hazards When Remodeling Your Home (September 1997)*. Pamphlet providing basic information about lead-based paint risks and precautions when remodeling pre-1978 homes.

F

B, I, K

Web Sites

- HUD. Office of Lead Hazard Control. Provides information on HUD regulations, technical and educational documents, and links to other lead resources.
- EPA. Office of Pollution Prevention and Toxics. Provides information on EPA regulations, technical and educational documents, and links to other lead resources.

B

K

Worker protection methods?
Publications

- *Protecting Workers and Their Communities from Lead Hazards: A Guide for Protective Work Practices and Effective Worker Training (1993)*.^{*} Guidance on worker protection methods, training workers, and complying with OSHA regulations. (About 500 pages)
- *Lead Exposure in the Construction Industry (1993)*. Fact sheets that describe worker protection measures needed to meet OSHA requirements for lead including respiratory protection and protective clothing. (Series of 6 fact sheets)

L

J

Web Site

- OSHA. Occupational Safety and Health Administration. Provides information on OSHA regulations, technical and educational documents, and links to other lead resources.

J

Preventing children's exposure to lead hazards?

Publications

- *Protect Your Family From Lead In Your Home (May 1995)*. Pamphlet that provides basic information about addressing and preventing lead-based paint hazards in the home.
- *Lead Poisoning Prevention: Directory of State Contacts (1997-98)*.* Booklet that contains profiles of state programs to reduce lead hazards. (150 pages)
- *Directory of State and Local Lead Poisoning Prevention Advocacy Organizations (1998)*.* List of state and local non-profit organizations that are working to prevent lead poisoning. (About 300 pages)

Web Site

- Alliance to End Childhood Lead Poisoning. Information on lead poisoning prevention, lead issues, and program design. Site has publications that can be copied from the web.

Public education and outreach materials?

Web Site and Hotline

- National Lead Information Center. Information about lead hazards and poisoning prevention.

Locating certified abatement contractors and clearance inspectors?

Web Site and Hotline

- Leadlisting. List of qualified lead professionals including inspectors, risk assessors, abatement contractors, and analysis laboratories.

Reference Letter

B, I, K

E

A

A

I

D

RESOURCES

5

59

Disclosure requirements?

Publications

- *Protect Your Family From Lead in Your Home (May 1995)*. Pamphlet that provides basic information about addressing and preventing lead-based paint hazards in the home.
- *Disclosure of Lead-Based Paint Hazards in Housing (March 1996)*. Fact sheet that provides information on how to meet Federal disclosure requirements.
- *Questions and Answers on the HUD/EPA Disclosure Rule*. Answers to commonly asked questions about Federal disclosure requirements. (5 pages)
- *Interpretive Guidance for the Real Estate Community on the Requirements for Disclosure of Information Concerning Lead-Based Paint in Housing, Parts I and II (1996)*. In-depth guidance on the disclosure requirements for real-estate professionals. (27 pages)
- *Resource Handbook on Lead Hazard Disclosure for Homes and Apartments (1996)*.* Comprehensive reference book on disclosure procedures including advice for renters and owners, a glossary of key terms, and copies of disclosure documents. (Approximately 300 pages)

Reference Letter

B, I, K

K

K

K

A

Respirators?

Web Sites

- National Institute of Occupational Safety and Health. Provides information on the proper use of respiratory protection and various types of NIOSH-approved respirators that are available.
- Occupational Safety and Health Administration. Provides information on OSHA regulations regarding the use of respiratory protection.

H

J

Where can I find...

HUD's lead regulations?

- 24 Code of Federal Regulations (CFR) 35 (Lead Rule). Contains lead hazard evaluation and reduction requirements for properties that receive HUD funding.

**Reference
Letter**

B

OSHA's lead regulations?

- 29 CFR 1926.62 (Lead in Construction) and 29 CFR 1910.1025 (Lead in General Industry). These regulations cover Federal worker protection requirements for workers in industry, construction, remodeling, and renovation.

J

EPA's lead regulations?

- 40 CFR 745 (Lead-Based Paint Poisoning Prevention in Certain Residential Structures). Contains the Federal regulations for the disposal of lead waste and contractor notification requirements.
- 40 CFR 745.80 (Residential Property Renovation). Federal rule requiring contractors to provide notification before the start of any work that disturbs a painted surface in pre-1978 homes.

K

K

Disclosure regulations?

- 24 CFR 35 (HUD) and 40 CFR 745 (EPA). Regulations for disclosure of known lead-based paint and lead-based paint hazards by home sellers and landlords. This rule was published jointly by HUD and EPA.

B, K

RESOURCES

5

61

State lead laws?	Reference Letter
Publication	
<ul style="list-style-type: none"> • <i>Summary of Lead Poisoning Prevention Statutes (February 1999)</i>. A state-by-state listing of local lead-related regulations, such as waste disposal requirements. Available by fax. (24 pages) 	E

Contacts

Reference Letter	Organization	Types of Resources
A	Alliance to End Childhood Lead Poisoning 227 Massachusetts Avenue, NE, Suite 200 Washington, DC 20002 202-543-1147 http://www.aeclp.org	Publications
B	Office of Lead Hazard Control (OLHC) U.S. Department of Housing and Urban Development (HUD) 451 Seventh Street, SW, Room P-3206 Washington, DC 20410 202-755-1785 http://www.hud.gov/lea/leahome.html	Publications Program development
C	HUD USER P.O. Box 6091 Rockville, MD 20849 1-800-245-2691 http://www.huduser.org	Publications
D	Leadlisting 1-888-Leadlist (1-888-532-3547) http://www.leadlisting.org	Technical consultation
E	National Conference of State Legislatures 1560 Broadway, Suite 700 Denver, CO 80202 303-830-2200 http://www.ncsl.org	Publications

Reference Letter	Organization	Types of Resources
F	National Center for Lead Safe Housing 10227 Wincopin Circle, Suite 205 Columbia, MD 21044 410-992-0712 http://www.leadshousing.org	Publications Technical consultation
G	National Institute of Building Sciences (NIBS) Publications Department 1201 L Street, NW, Suite 400 Washington, DC 20005-4014 202-289-7800 http://www.nibs.org	Publications Training
H	National Institute of Occupational Safety and Health (NIOSH) Hubert H. Humphrey Building, Room 7154 200 Independence Avenue, SW Washington, DC 20201 800-35-NIOSH (800-356-4674) http://www.cdc.gov/niosh/homepage.html	Publications
I	National Lead Information Center (NLIC) 8601 Georgia Avenue, Suite 503 Silver Spring, MD 20910 Information Clearinghouse: 1-800-424-Lead (1-800-424-5323) http://www.epa.gov/lead/nlic.htm	Publications Training

RESOURCES

Reference Letter	Organization	Types of Resources
J	<p>Occupational Safety and Health Administration (OSHA) U.S. Department of Labor, OSHA Publications Office 200 Constitution Avenue, NW, Room N3101 Washington, DC 20210</p> <p><i>OSHA Lead web page:</i> http://www.osha-slc.gov/SLTC/lead/index.html</p> <p><i>OSHA Respirator web page:</i> http://www.osha-slc.gov/SLTC/respiratory_advisor/mainpage.html</p>	<p>Technical consultation Enforcement</p>
K	<p>Office of Pollution Prevention and Toxics (OPPT) U.S. Environmental Protection Agency (EPA) 401 M Street, SW (7401) Washington, DC 20460 202-260-3810 http://www.epa.gov/lead</p>	<p>Publications Program development</p>
L	<p>Society for Occupational & Environmental Health 6728 Old McLean Village Drive McLean, VA 22101 703-556-9222 http://www.soeh.org</p>	<p>Publications</p>

C. GETTING THE WORD OUT

How Owners and Occupants Can Work Together to Improve Lead Safety In Homes

Gaining tenant cooperation can help rental property owners and managers respond promptly to conditions that could pose a health threat to occupants.

Owner Responsibilities

1. Check the building to be sure that:

- The building shell is sound.
- Water isn't coming in from the outside and causing damage.
- Sources of moisture inside are not causing damage.
- Painted surfaces are intact.
- Doors and windows work properly.
- All surfaces are clean and cleanable.

2. Maintain the building.

- Train maintenance staff to minimize dust, clean up effectively, and protect themselves.
- Conduct regular building checks for potential problems, such as:
 - Flaking or peeling paint
 - Water damage to paint, plaster, or wood
 - Plumbing or roof leaks
 - Painted doors and windows that do not operate smoothly

3. Educate occupants and gain their cooperation.

- Fulfill Federal notice and disclosure requirements.
- Have occupants inform you of damaged paint and other maintenance problems.

When Maintenance or Renovation Work is Done

Give occupants the Lead Safety pamphlet required by Federal regulations (see page 66).

Tell occupants:

- ✓ Why repairs are necessary.
- ✓ The work schedule.
- ✓ How they and their possessions will be protected.
- ✓ Why they may need to leave during the work.

RESOURCES

- ❑ Explain to occupants why steps, such as regular cleaning, prevent lead-based paint hazards. (See below.)
- ❑ Consider providing cleaning supplies and tools (see page 75) to occupants to encourage cleaning.
- ❑ Remind tenants that it is a good practice to provide notice of problems in writing.
- ❑ Make sure occupants understand the property's maintenance reporting procedures and indicate that these problems require priority attention.

Precautions Tenants Can Take to Protect Their Family

Occupants should pay special attention to page 7 of the pamphlet *Protect Your Family From Lead In Your Home*. It describes steps that occupants can take to reduce the chance that they will be exposed to lead hazards. Suggestions from this pamphlet include:

- ❑ Clean floors, window frames, interior window sills, and other flat surfaces each week using warm water and an all-purpose cleaner.
- ❑ Clean up any paint chips immediately.
- ❑ Keep child play areas clean.
- ❑ Wash children's hands often.
- ❑ Keep children from chewing interior window sills and other painted surfaces.

Federal Notice and Disclosure Requirements

(24 CFR Part 35 or
40 CFR Part 745)

- ✓ Landlords and home sellers must notify future occupants about lead-based paint hazards by giving them the pamphlet *Protect Your Family From Lead in Your Home*.
- ✓ Landlords and home sellers must disclose information about known lead-based paint and/or lead-based paint hazards before dwelling leases or home sales contracts take effect. Leases and sales contracts must also include a form about lead-based paint that meets Federal requirements. Contact HUD or EPA for more information about these requirements (see Section 5B, p. 57).

Notice Prior to Renovation

Federal law requires contractors and owners of rental properties to inform occupants about the risks of lead-based paint before non-emergency repair, maintenance, and home renovation work begins. This law applies for all work on surfaces greater than 2 square feet per component. Contractors and property owners must distribute copies of the pamphlet *Protect Your Family From Lead In Your Home* before any work starts. See EPA's regulation at 40 CFR 745.80. Also see Section 5B, p. 57, for sources that can provide copies of this pamphlet.

Contractors and owners must make sure that occupants have received the pamphlet.

- For owner-occupied homes, the contractor must have the homeowner sign an acknowledgement form after receiving the pamphlet. Or, the contractor can send the pamphlet by certified mail.
- For tenants, the contractor or property owner must have an adult occupant sign an acknowledgement form after receiving the pamphlet. Or, the contractor or owner can send the pamphlet by certified mail. If the contractor cannot get a signed acknowledgement, the contractor must sign a statement documenting this.
- For work in common areas, such as the lobby, of an apartment building, the contractor must give the pamphlet to the owner and to the occupants of all affected areas and inform them of the nature, location, timing, and length of the job.

Why Lead Safety Makes Sense for Property Owners and Contractors

Property owners and contractors that use safe work practices benefit in several ways.

Advantages for Owners of Residential Rental Properties

Owners who maintain their rental properties using work practices that increase lead safety can use this information to attract tenants who are concerned for their child's health. Some local agencies may even maintain a listing of housing units that meet certain lead-safety standards. When giving prospective tenants the lead-based paint pamphlet and the required disclosure information, they can tell the tenant that the property has a program to minimize the risk of hazards from lead-based paint. A safety program would include:

RESOURCES

5

67

- Educating and training maintenance workers.
- Examining property at turnover and then every year for deteriorating paint.
- Correcting conditions that may cause paint to flake and peel (excessive moisture, binding doors, etc.).
- Doing work safely and cleaning up well.
- Making sure surfaces are cleanable and doing a professional cleaning at turnover.
- Performing dust wipe tests before occupancy, and after every maintenance job that disturbs old paint. It is also recommended to perform a dust wipe sample test at least every two years. Keep the results on file.
- Encouraging tenants to inform property owners if there is a problem.

Advantages for Contractors

Doing work safely can enhance a contractor's reputation, maintain the safety of workers, and protect the health of customers and their children.

A program for lead safety can also help contractors when bidding new jobs. For example, contractors performing repairs and improvements in homes built before 1978 must give potential customers a pamphlet about the risk of lead-based paint during renovation.

Contractors that follow practices for lead safety can demonstrate to customers that they understand the risks and show that their workers take specific precautions to protect against lead-based paint hazards. Lead-safety can help "give you a leg up" on the competition.

Safe work practices also offer benefits that are important to customers:

- Dust and debris are confined to the work area.
- A "clean" work area at the end of the job.
- Some work offers additional benefits. *(For example, repairs to windows can improve their operation, prevent damage from moisture, and lower energy and maintenance costs.)*
- Lead safety also helps protect you as a contractor. For example, having an independent, certified professional take dust wipe samples of the work area promptly after cleanup provides strong documentation that no lead hazards were present in the work area at the end of the job.

D. MORE ABOUT TECHNICAL TOPICS

Respiratory Protection

Respiratory protection helps prevent workers from breathing harmful amounts of lead and other substances, touching their mouths with dusty hands, or swallowing paint chips.

When work creates high levels of dust in the air, properly trained and certified lead-based paint professionals should do these high dust jobs. If you work for someone, and plan on doing this type of work, your employer must meet the requirements of the OSHA Lead in Construction Standard (29 CFR 1926.62). These requirements include respiratory protection when work creates lead dust in air that exceeds the “permissible exposure limit” (PEL) — see Air Monitoring and Results sections below. See Section 5B, p. 57, for sources of information about OSHA requirements.

Respirators may be required for activities that generate high levels of dust such as:

- Demolishing painted surfaces
- Opening up wall and ceiling cavities
- Using power tools on painted surfaces
- Dry scraping large painted areas

For this type of work, OSHA requirements include the following:

- Training workers on how to properly use and maintain respirators.
- Making sure proper respirators are always available and that workers have been fit tested. Where respirator use is required, workers must be part of a written respiratory protection program that meets OSHA standards (29 CFR 1910.134).

Many types of respirators can be used:

- Disposable respirators can be used if they are rated by NIOSH as N100 (or HEPA) — this information can be found on the respirator’s package or the respirator itself.

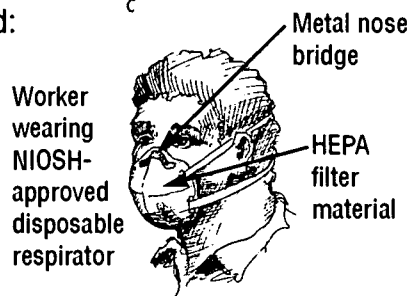
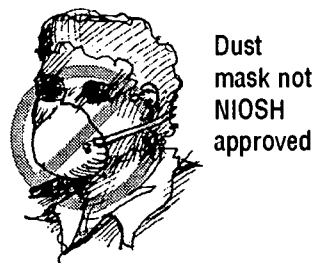

RESOURCES

- Non-disposable respirators, also rated by NIOSH as N100, often have replaceable cartridges and require regular maintenance.
- 
- Worker wearing a non-disposable respirator
- Having a trained person do air monitoring that measures the amount of dust in the air to determine if respirators are required by OSHA, and the appropriate level of protection. Workers must wear proper respirators while air monitoring is being done.

Air Monitoring

Air monitoring is done to ensure that workers are not being exposed to dangerous levels of lead dust in the air, and to comply with OSHA requirements. It must be done by a person with special training. A worker being monitored wears a small plastic canister clipped to his/her clothing near the face. A pump in a device clipped to the belt draws air and dust into the canister. The canister is then sent to a lab to measure how much lead dust was in the air.

What Do the Results Mean?

The results are measured in micrograms per cubic meter ($\mu\text{g}/\text{m}^3$). If the amount of lead dust in the air exceeds the permissible exposure limit (PEL) of $50 \mu\text{g}/\text{m}^3$, workers must wear at least a half-face respirator with an N100 (or HEPA) rating and certain OSHA requirements must be followed.

Results may show that respirators are not necessary or that a greater level of protection is needed. If the results show lead dust levels in the air above $500 \mu\text{g}/\text{m}^3$, a more protective respirator is required.

Other Protection

In addition to respiratory protection for activities that generate high levels of dust, compliance with OSHA's Lead in Construction Standard may involve blood tests for workers, medical monitoring, hand washing facilities, other personal protective equipment, shower and changing areas, and additional training.

Testing Dust for Lead

By having dust wipe samples taken, job supervisors and property owners can locate dust lead hazards and test the effectiveness of cleaning at the end of a job.

Where Are Dust Samples Taken?

Samples are taken in the area of the dwelling where work has been completed. The following surfaces within the work area should be sampled:

- Floor
- Interior window sills (*also referred to as window stools*)
- Window troughs

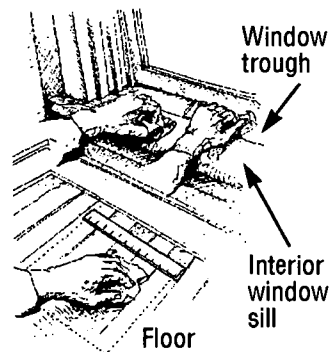

When Should Dust Samples Be Taken?

- At the end of a job
- If there is a child or pregnant woman living in the home
- Before a family moves into a home

What Do the Results Mean?

The results of the laboratory analysis will show the amount of lead found in the dust from the area sampled. The results are measured in micrograms per square foot ($\mu\text{g}/\text{ft}^2$).

To determine if a lead-based paint hazard exists, based on HUD's requirements as of winter 1999, compare the results to the following standards.

- 100 $\mu\text{g}/\text{ft}^2$ on the floor
- 500 $\mu\text{g}/\text{ft}^2$ on the interior window sill (stool)
- 800 $\mu\text{g}/\text{ft}^2$ in the window trough

HUD-assisted, and some federally-owned housing: After 9/14/2000, use 40 for floors, 250 for sills, and use trough value only for clearance.

If the results for a sample are higher than these standards, a dust lead hazard is present.

RESOURCES

5

71

Who Can Take Dust Wipe Samples?

Following painting, home maintenance, and renovation work:

- In homes receiving Federal assistance, dust wipe samples, if required by regulations, must be taken by a trained and certified person.
- For all other homes, it is recommended that dust wipe samples be taken by a trained person, and it is preferable that they be certified. Some states require that dust wipe samples be taken by certified persons.

What Actions Do I Take Based On the Results?

If the results show dust lead levels higher than the standards listed above, the area where the work was performed should be cleaned to remove the dust lead hazard.

If the dust wipe samples were taken as part of ongoing monitoring by maintenance staff or the property owner, the surfaces where work was performed should be examined to see if the work has failed or new conditions that generate dust have developed. In either case, these conditions should be corrected using lead-safety principles and work practices.

If the work required to correct the likely source of the dust lead hazard is beyond the scope of this guide, the property owner should seek the help of a lead-based paint professional trained to safely correct lead-based paint hazards.

Setting Up a Dust Room

A dust room can be useful for dusty work on building components that can be moved. For example, scraping or planing doors or window sashes can be done in a dust room. A dust room is particularly useful when working in occupied spaces.

The dust room can be any room that can be closed off. The door can be covered with a flap system (see page 46) and the floor can be covered with protective sheeting taped to the baseboard.

Workers in this room should wear disposable clothing and wear respiratory protection. Wall and ceiling vents inside the room should be sealed off.

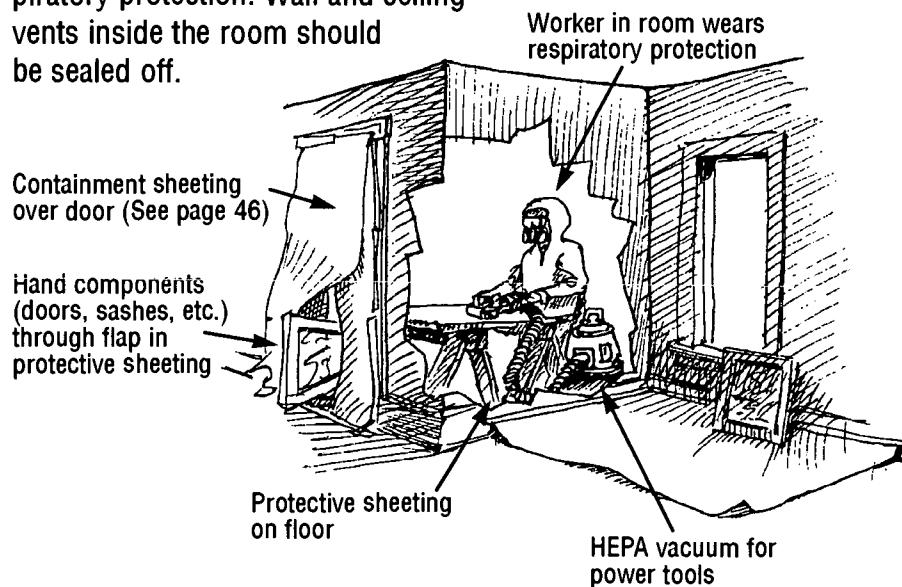

RESOURCES

5

73

Building a Door Hold

A door hold makes working on doors easier and safer.

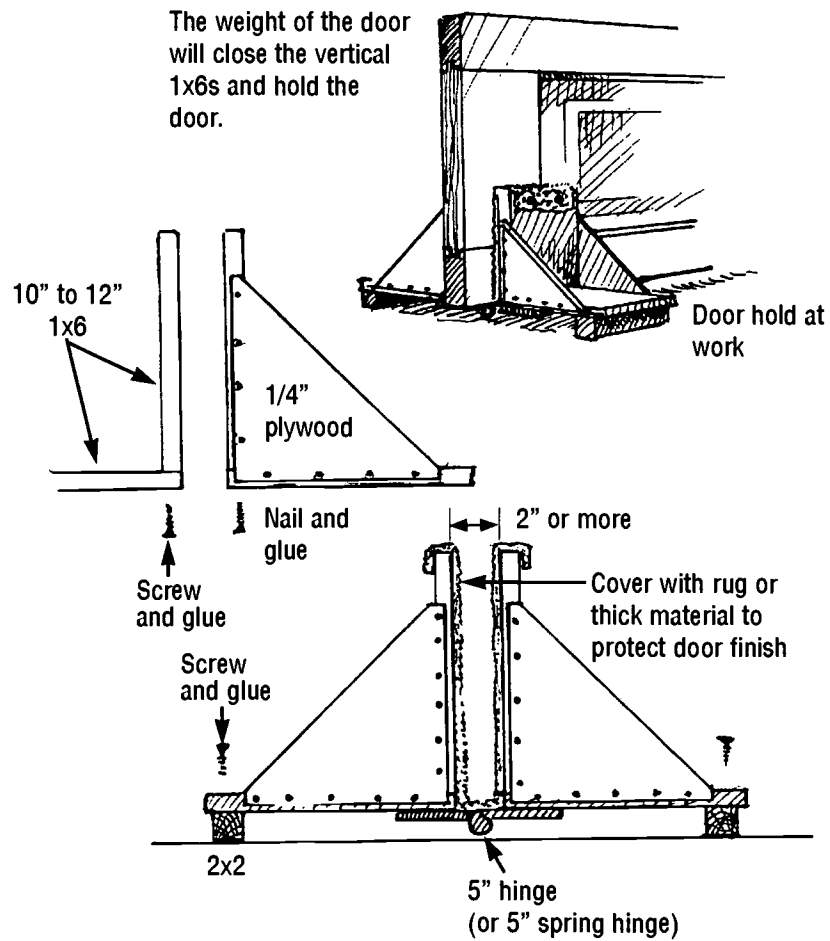

E. TOOL AND SUPPLY LIST

Additional Tools Needed for Lead-Safety Work

(Not every tool is needed for every job.)

Paint scrapers - A variety of scrapers are useful; carbon blades last longest. A mill file works well to keep scraper blades sharp.

Sanding sponges and wet/dry sandpaper - Where areas need to be smoothed or feathered, these abrasive tools, when used wet, keep dust to a minimum.

Mist bottles - Misting a surface being scraped or cut keeps down dust. Squeeze bottles work best in small areas. For larger jobs, a pump pressure sprayer in a knapsack works best.

Plane - A jack, smooth, or jointer (not block) plane. Hand planes are good for removing paint from edges such as the edge of a window, stool, or door. They create very little dust.

Cleanup station - A kitchen counter with a working sink is a good place for a cleanup station. If not available, set up a board with 3 buckets and a pump sprayer.

The station should have:

- Paper towels and soap
- Pads for cleaning respirators
- A 2-bottle eye-wash station
- A first aid kit
- Clipboard with emergency numbers
- Drinking water and cups

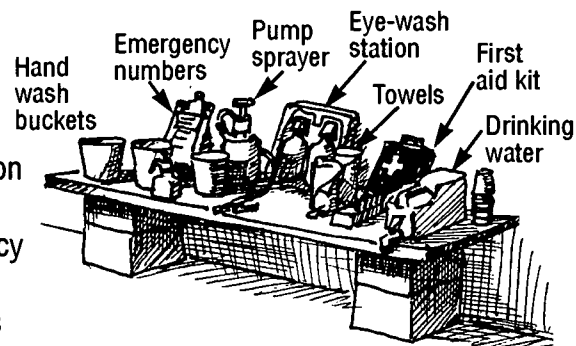

Personal Protective Clothing and Equipment

- A disposable respirator rated by NIOSH as N100 (or HEPA)
- A half-face, air cartridge respirator rated by NIOSH as N100 (or HEPA)
- Protective, lightweight, disposable suits with elastic sleeves and ankles
- Shoe covers (slip resistant is recommended)
- Safety glasses (vented goggles if working in high dust conditions or when using liquids or strippers)
- Ear protection if using power tools

RESOURCES

Cleaning Equipment

- Bottle mister and pump sprayer for detergent
- Mops and buckets
- Tack cloths for wiping furnishings that may be damaged by water
- Heavy-duty paper towels and/or rags

Vacuums - At the end of a job, use a HEPA vacuum because it will capture even the finest dust. For regular household cleaning, use a HEPA vacuum if available. If one is not available, use a fine filter in your vacuum known as micron or allergen bags.

Painting Supplies

- Use commercial grade cleaners; there are also lead-specific cleaners. (Note: Trisodium phosphate [TSP] is banned in some states.)
- Degreasers may be necessary on some walls.
- Use deglosser or wet sanding supplies.
- Where wood is exposed, use a sealer and then apply a best grade primer or primer-sealer.

Other Tools

- Coil stock for covering window troughs. Coil stock is available with white and brown sides to match window trim color (see page 36).
- Window opening tool for windows that are painted shut (see page 29).
- Brace with screwdriver tips for removing and replacing hinge screws.
- Power planer with exhaust port that can be attached to HEPA vacuum. A power planer can be used for stripping window sashes and doors in a contained work area with respiratory protection.

G . W O R K C H E C K L I S T

Before Work Begins

- Are the possible risks to occupants identified?
- Are the occupants informed of the possible risks and their responsibilities?
- Are the causes of the problems located?
- Is the work area set up?
- Is the work area closed off from occupants?

During Work

- Are dust and debris being contained in the work area?
- Are workers wearing necessary protective clothing and equipment?
- Are workers cleaning up each time they leave the work site?

At the End of the Job

- Did workers fix the cause of the problem?
- Did workers remove visible dust and debris?
- Did workers properly dispose of dust and debris?
- Did workers wet wash the surfaces?
- Were dust samples taken to make sure that cleanup worked?

For Long-Term Maintenance

Is there a plan to:

- Maintain painted surfaces?
- Keep surfaces clean and cleanable?
- Prevent water and moisture damage?

This Guide may be reproduced and distributed without prior permission from the U.S. Department of Housing and Urban Development or any other Federal Agency.

Disclaimer: The guidance offered in this document is based upon the latest lead hazard control knowledge and technology available at the time it was written. Users bear all risks associated with reliance on these work practices and have sole responsibility for evaluating the information it contains. Users bear sole responsibility to form their own independent judgments on the document's use, modification, and adaptation as appropriate. Neither the United States Government nor any of its employees makes any warranty, expressed or implied, or assumes any legal liability for any use of, or the results of, any information, product, or process discussed in this document.

Why Follow this Guide?

The Simple Work Practice Changes in this Guide Can Protect Children and Workers

- This Guide contains practical steps for lead safety.
- With small changes in work practices, workers can protect themselves, their families, and their customers, especially children, from lead exposure.

Painting, Home Improvement, and Maintenance Work in Older Homes Can Endanger Children

- Most homes built before 1978 contain lead-based paint.
- Doing work improperly can create a lot of paint chips and dust that may contain lead.
- Lead in paint chips, dust, and soil gets on children's hands and toys which they may put in their mouths.
- Lead can make children very sick and cause permanent brain and nerve damage, learning difficulties, and behavior problems.

Poor Maintenance Also Endangers Children

- Paint flaking and peeling is often caused by moisture.
- Rubbing or impact on doors, windows, and trim can cause paint failure.

Who Should Use This Guide?

- Building maintenance workers and supervisors
- Painters
- Repair, renovation, and remodeling contractors
- Property managers and owners
- Homeowners

Ordering Additional Copies

Single copies of *Lead Paint Safety: A Field Guide for Painting, Home Maintenance, and Renovation Work* on paper or on CD-ROM can be ordered from the National Lead Information Center at 1-800-424-5323 or downloaded from the HUD Office of Lead Hazard Control web site at www.hud.gov/lea/leahome.html.

For information about obtaining multiple copies, contact the National Lead Information Center.

June 1999
HUD-1779-LHC

APPENDIX 2

Information About Key HUD Requirements Regarding Lead-Based Paint and the Responsibilities of Key Federal Agencies

**Summary of U.S. Department of Housing and Urban Development
(HUD) Requirements for Safe Work Practices**

**Responsibilities of Key Federal Agencies
Regarding Lead-Based Paint**

Summary of U.S. Department of Housing and Urban Development (HUD) Requirements for Safe Work Practices

This appendix describes safe work practices required in HUD-funded work that disturbs paint in housing built before 1978. The regulations can be found in the Code of Federal Regulations (CFR) at 24 CFR 35.1350. They can also be found on the Internet at www.hud.gov/offices/lead. The brief summary of HUD's requirements provided here will be useful if you work now or will work in the future on HUD-funded rehabilitation projects or other federally assisted housing projects.

In most cases, it is the responsibility of the agency (public, nonprofit, or private) that administers the rehabilitation project or the individual / organization who accepts HUD funds to make sure that HUD's requirements are followed. However, the contractors who work on HUD-funded projects are required to know and use the proper practices for set up, safe work practices, and cleanup. Contractors should also cooperate with the agency and property owners to make sure that the job is carried out safely.

The HUD regulations that apply most to contractors who do routine renovation, remodeling and rehabilitation that is funded by HUD relate to:

- Training Requirements
- Occupant Protection;
- Safe Work Practices;
- Cleanup; and
- Clearance.

TRAINING REQUIREMENTS

Contractors who perform rehabilitation, maintenance, repainting, or interim lead-based paint hazard controls on most pre-1978 HUD-associated housing, and are disturbing paint that is known or presumed to be lead-based paint must have taken a HUD-approved course in lead-safe work practices. If workers have not taken such a course they must be supervised by a certified lead-based paint abatement supervisor, who is responsible for assuring that the work is done safely and effectively.

There is an exception to the training requirement for jobs receiving no more than \$5,000 per dwelling unit in Federal rehabilitation funds. In such cases, HUD requires the use of safe work practices, but allows the local recipient of funds to decide how to assure that the workers are trained or supervised to ensure that the work is performed safely.

OCCUPANT PROTECTION

Contractors must take steps to protect occupants from lead-based paint hazards while the work is in progress.

- Occupants may not enter the worksite. Occupants are allowed to return only after the work is done and the home has passed a clearance examination that checks for deteriorated lead-based paint and harmful levels of lead-contaminated dust.
- Occupants' belongings must be protected from lead contamination. This can be done by removing them from the work area or covering them with protective sheeting and sealing it to prevent dust from getting on the items.
- The work site must be set up to prevent the spread of leaded dust and debris.
- Warning signs must be posted at entrances to the worksite when occupants are present; at the main and secondary entrances to the building; and at exterior work sites. The signs must be readable from 20 feet from the edge of the worksite. Signs must be in the occupants' primary language when practicable.
- It may be necessary to temporarily move occupants out of the unit if work will take several days and it involves kitchens, bathrooms, or bedrooms. This is the responsibility of the dwelling's owner.

SAFE WORK PRACTICES

HUD prohibits several practices (see exhibit 1, below). The safe practices described in Module 3 of this training are good alternatives to the prohibited practices listed here. Safe work practices are not required:

- If paint has been tested and found not to be lead-based paint by an EPA or State certified risk assessor or inspector, or
- If the work disturbs a total painted surface area that is:
 - Less than 20 ft.² on exterior surfaces;
 - Less than 2 ft.² in any one interior room or space; or
 - Less than 10 percent of the total surface area on an interior or exterior type of component with a small surface area like window sills, baseboards, and trim.

Exhibit 1: HUD Prohibited Work Practices

- Open flame burning or torching.
- Machine sanding or grinding with out a high-efficiency particulate air (HEPA) local exhaust control.
- Abrasive blasting or sandblasting without HEPA local exhaust control.
- Heat guns operating above 1,100 degrees Fahrenheit, or those that operate high enough to char the paint.
- Dry sanding or dry scraping.
- Paint stripping in a poorly ventilated space using a volatile stripper that is a hazardous substance.

There are several circumstances when limited use of these prohibited methods is allowed under HUD regulations:

- Dry scraping in conjunction with heat guns;
- Dry scraping within 1.0 ft of electrical outlets;
- Dry scraping deteriorated paint spots that total no more than 2 ft.² in any one interior room or space; or
- Dry scraping deteriorated paint spots that total no more than 20 ft.² on exterior surfaces.

Note: Use of paint strippers with methylene chloride can be hazardous and is prohibited in poorly ventilated areas (such as when the concentration will exceed the permissible exposure limit for methylene chloride).

CLEANUP

Worksite cleanup removes dust and debris from the work area. Good cleanup is critical to passing clearance and leaving the unit safe for habitation. Worksite cleanup must be done using methods, products, and devices that are successful in cleaning lead-contaminated dust, such as vacuum cleaners with HEPA filters or equivalent equipment, and wet cleaning with household or lead-specific detergents or equivalent products.

CLEARANCE

Clearance is a process to test the work site to assure that any lead in dust does not exceed HUD standards and that there is no deteriorated paint that might contain lead. After the work is done and before the residents can return, the work area or unit must pass clearance. In a clearance examination, a clearance examiner:

- Performs a visual assessment of the worksite or unit to look for deteriorated paint and visible amounts of dust, debris, paint chips or other residue. If these are found in areas where dust sampling is required they must be eliminated before continuing the clearance examination. If deteriorated paint is found, it must be stabilized using safe work practices. If visible dust and debris is found, it must be cleaned up;
- Takes several dust wipe samples from floors, interior window sills (stools), and window troughs and sends them to a laboratory for lead analysis. If leaded dust above HUD standards are found, the worksite or unit must be re-cleaned and another dust clearance tested conducted.

It is usually the responsibility of the organization or owner overseeing the work to arrange for the clearance. However, it is often the contractor who is responsible for cleaning sufficiently to pass clearance. Some agencies may state in the construction contract that if clearance is not passed the first time, the contractor will be held responsible for paying for an adequate second cleaning and clearance test.

- Clearance must be performed by a certified examiner (a risk assessor, lead-based paint inspector, or lead sampling/clearance technician), or a trained lead sampling/clearance technician whose work is approved by a certified risk assessor or lead-based paint inspector. Certified sampling technicians cannot conduct clearance after lead abatement, but only after other lead hazard control activities like paint stabilization. State requirements for sampling technicians may vary, so the state regulatory authority should be consulted.
- The contractor cannot perform clearance. The HUD regulations state that the person conducting the lead hazard reduction activities and clearance must be independent of each other. However, an organization or owner that is responsible for regulatory compliance may use a qualified in-house employee to conduct clearance if that same employee does not conduct both 1) a hazard reduction, rehabilitation, or maintenance activity and 2) the clearance examination.

Clearance Standards

If the test results equal or exceed the following HUD interim standards, the dwelling unit, worksite, or common area fails the clearance examination. (Note: EPA's guidance currently has different thresholds. After EPA's lead hazard standards rule goes into effect, HUD will adopt them.)

- Floors: 40 $\mu\text{g}/\text{ft.}^2$
- Interior windows sills (stools): 250 $\mu\text{g}/\text{ft.}^2$
- Window troughs: 800 $\mu\text{g}/\text{ft.}^2$ EPA's rule is set to change this to 400 $\mu\text{g}/\text{ft.}^2$

Clearance is not required when:

- Maintenance or a lead hazard reduction activity at a worksite does not disturb painted surfaces; or
- If the total area of the painted surface disturbed does not exceed the following:
 - 20 ft.^2 on exterior surfaces;
 - 2 ft.^2 in any one interior room or space; or
 - 10 percent of the total surface area on an interior or exterior type of component with a small surface area like windowsills, baseboards, and trim.



HUD Sets New Requirements to Prevent Childhood Lead Poisoning in Housing Assisted or Being Sold by the Federal Government

SUMMARY

The U.S. Department of Housing and Urban Development (HUD) has issued a new regulation to protect young children from lead-based paint hazards in housing that is financially assisted by the federal government or being sold by the government. The regulation, "Requirements for Notification, Evaluation and Reduction of Lead-Based Paint Hazards in Federally Owned Residential Property and Housing Receiving Federal Assistance," was published in the Federal Register on September 15, 1999. The hazard reduction requirements in this regulation are based on scientific research and the practical experience of cities, states, and others who have been controlling lead-based paint hazards in low-income housing through HUD assistance. The requirements apply to housing built before 1978, the year lead-based paint was banned nationwide for consumer use.

The new regulation puts all of the Department's lead-based paint regulations in one part of the Code of Federal Regulations, making it much easier to find HUD policy on the subject. The new requirements will take effect on September 15, 2000, one year after publication, to allow time for housing owners and state and local agencies to prepare for compliance. HUD estimates that about 2.8 million housing units will be affected by the regulation during its first five years.

LEAD POISONING PREVENTION

Lead poisoning can cause permanent damage to the brain and many other organs, and can result in reduced intelligence and behavioral problems. Lead can also harm the fetus. More than 800,000 children younger than 6 years old living in the United States have lead in their blood that is above the level of concern set by the Centers for Disease Control and Prevention (CDC). A large portion of these children are in families of low income and are living in old homes with heavy concentrations of lead-based paint. The most common sources of childhood exposure to lead are deteriorated lead-based paint and lead-contaminated dust and soil in the residential environment.

HUD estimates that the regulation will protect more than two million children from exposure to lead during its first five years. The estimated net benefits (that is, benefits minus costs) from the first five years are \$2 billion, mostly from increased lifetime earnings but also including reductions in medical and special education costs. Additional benefits that have not been estimated in dollar terms include reduced family time, and anxiety involved in caring for lead-poisoned children, increased stature and hearing ability, reduced hypertension in later life, and reduced juvenile delinquency and crime.

LEGISLATIVE BACKGROUND

The new regulation is being issued under sections 1012 and 1013 of the Residential Lead-Based Paint Hazard Reduction Act of 1992, which is Title X ("ten") of the Housing and Community Development Act of 1992. Sections 1012 and 1013 of Title X amended the Lead-Based Paint Poisoning Prevention Act of 1971, which is the basic law covering lead-based paint in federally associated housing. The new regulation appears within title 24 of the Code of Federal Regulations as part 35 (24 CFR 35).

WHAT ARE THE REQUIREMENTS?

The regulation sets hazard reduction requirements that give much greater emphasis than existing regulations to reducing lead in house dust. Scientific research has found that exposure to lead in dust is the most common way young children become lead poisoned. Therefore the new regulation requires dust testing after paint is disturbed to make sure the home is lead-safe. Specific requirements depend on whether the housing is being disposed of or assisted by the federal government, and also on the type and amount of financial assistance, the age of the structure, and whether the dwelling is rental or owner-occupied.

A summary of the hazard reduction requirements for the various types of housing programs is attached to the Questions and Answers issued in association with this regulation. More detailed information is available in training and guidance material, in the regulation itself, and in the Department's explanation of the regulation, published in the Federal Register.

TYPES OF HOUSING COVERED

- Federally-owned housing being sold
- Housing receiving a federal subsidy that is associated with the property, rather than with the occupants (project-based assistance)
- Public housing
- Housing occupied by a family receiving a tenant-based subsidy (such as a voucher or certificate)
- Multifamily housing for which mortgage insurance is being sought
- Housing receiving federal assistance for rehabilitation, reducing homelessness, and other special needs

TYPES OF HOUSING NOT COVERED

- Housing built since January 1, 1978, when lead paint was banned for residential use
- Housing exclusively for the elderly or people with disabilities, unless a child under age 6 is expected to reside there
- Zero-bedroom dwellings, including efficiency apartments, single-room occupancy housing, dormitories, or military barracks
- Property that has been found to be free of lead-based paint by a certified lead-based paint inspector
- Property where all lead-based paint has been removed
- Unoccupied housing that will remain vacant until it is demolished
- Non-residential property
- Any rehabilitation or housing improvement that does not disturb a painted surface

FOR MORE INFORMATION

If you want copies of the regulation or have general questions, you can call the National Lead Information Center at (800) 424-LEAD, or TDD (800) 526-5456 for the hearing impaired. You can also download the regulation and other educational materials at www.hud.gov/lea. For further information, you may call HUD at (202) 755-1785, ext. 104, or e-mail HUD at lead_regulations@hud.gov.

The new regulation puts all of the Department's lead-based paint regulations in one part of the Code of Federal Regulations, making it much easier to find HUD policy on the subject.

RESPONSIBILITIES OF KEY FEDERAL AGENCIES REGARDING LEAD-BASED PAINT

Environmental Protection Agency (EPA) Responsibilities:

EPA is responsible for protecting human health and safeguarding the natural environment. Under the Toxic Substances Control Act (TSCA), Title IV, EPA has developed or is developing regulations regarding the following:

- Training, certification and work practice standards for individuals and firms conducting lead-based paint activities (inspection, risk assessment, abatement) (TSCA section 402(a))
- Authorization of States and Indian Tribes to run their own lead-based paint training and certification program (TSCA section 404)
- Identification of hazardous levels of lead in paint, dust and soil (TSCA section 403)
- Providing a lead hazard information pamphlet to be distributed to persons before they buy or rent a home or before renovation and remodeling activities are conducted in their home (TSCA section 406(b))
- Training, certification and work practice standards for individuals and firms conducting renovation and remodeling activities (TSCA section 402(c))
- EPA information and materials can be obtained on the Internet (www.epa.gov/lead/) or by contacting the National Lead Information Center at 1-800-424-LEAD (800-424-5323).

Department of Housing and Urban Development (HUD) Responsibilities:

HUD is responsible for setting requirements for federally owned or assisted housing and operating the Lead Hazard Control Grant Program for privately owned low-income housing. Most pre-1978 properties receiving HUD funds are subject to HUD requirements for lead-based paint. Under the Residential Lead-Based Paint Hazard Reduction Act of 1992, commonly called Title X ("Title Ten"), HUD has:

- Developed regulations for how contractors and employees must work with lead paint when doing lead hazard reduction or abatement work on HUD-owned/assisted housing (e.g., "public housing" or Section 8 housing rehabilitation funded by CBDG or HOME).
- Developed regulations affecting training and work practices for operations and maintenance work on housing receiving federal assistance.
- Required training in lead-safety for all workers performing rehabilitation activities in units built before 1978.
- HUD guidelines and materials can be obtained on the Internet (www.hud.gov/offices/lead)

Occupational Health and Safety Administration (OSHA) Responsibilities:

OSHA is responsible for developing standards to protect worker health and safety on the job. Under Title X, OSHA has developed:

- A standard to prevent lead exposure on construction jobs (29 Code of Federal Regulations 1926.62, Interim Final Lead Exposure in Construction Standard).
- This training does not address OSHA standards or requirements.

Centers for Disease Control and Prevention (CDC) Responsibilities:

CDC is responsible for promoting health and quality of life by preventing and controlling disease, injury, and disability.

- CDC first published guidance on the prevention of childhood lead poisoning in 1975. CDC issued updates to these guidelines in 1978, 1985, and 1991.
- The current guidance is entitled, "Screening Young Children for Lead Poisoning: Guidance for State and Local Public Health Officials." The guidance makes recommendations to improve the effectiveness of lead screening. Other audiences include public health agencies, health care organizations including managed-care organizations, pediatricians, and other providers of health care to children.
- CDC guidelines and materials can be obtained on the Internet (www.cdc.gov) or by contacting 800-311-3435.

APPENDIX 3

Protect Your Family from Lead in Your Home Pamphlet

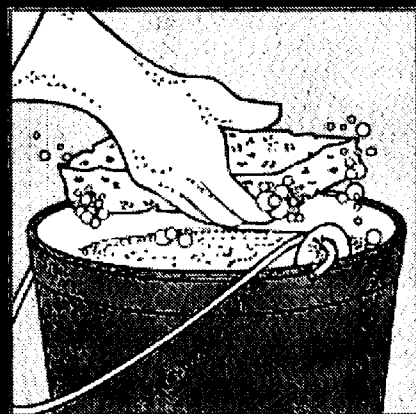
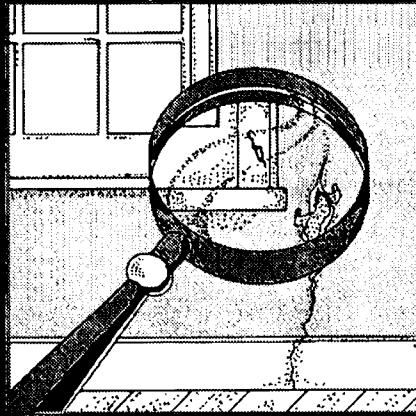

Protect Your Family From Lead In Your Home

United States
Environmental
Protection Agency

United States
Consumer Product
Safety Commission

United States
Department of Housing
and Urban Development

U.S. EPA Washington DC 20460
U.S. CPSC Washington DC 20207
U.S. HUD Washington DC 20410

EPA747-K-99-001
April 1999

Are You Planning To Buy, Rent, or Renovate a Home Built Before 1978?

Many houses and apartments built before 1978 have paint that contains lead (called lead-based paint). Lead from paint, chips, and dust can pose serious health hazards if not taken care of properly.

Federal law requires that individuals receive certain information before renting, buying, or renovating pre-1978 housing:



LANDLORDS have to disclose known information on lead-based paint and lead-based paint hazards before leases take effect. Leases must include a disclosure form about lead-based paint.



SELLERS have to disclose known information on lead-based paint and lead-based paint hazards before selling a house. Sales contracts must include a disclosure form about lead-based paint. Buyers have up to 10 days to check for lead hazards.



RENOVATORS have to give you this pamphlet before starting work. (After June 1, 1999.)

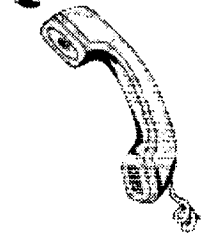

IF YOU WANT MORE INFORMATION on these requirements, call the National Lead Information Clearinghouse at **1-800-424-LEAD**.

This document is in the public domain. It may be reproduced by an individual or organization without permission. Information provided in this booklet is based upon current scientific and technical understanding of the issues presented and is reflective of the jurisdictional boundaries established by the statutes governing the co-authoring agencies. Following the advice given will not necessarily provide complete protection in all situations or against all health hazards that can be caused by lead exposure.

IMPORTANT!

Lead From Paint, Dust, and Soil Can Be Dangerous If Not Managed Properly

- FACT:** Lead exposure can harm young children and babies even before they are born.
- FACT:** Even children who seem healthy can have high levels of lead in their bodies.
- FACT:** People can get lead in their bodies by breathing or swallowing lead dust, or by eating soil or paint chips containing lead.
- FACT:** People have many options for reducing lead hazards. In most cases, lead-based paint that is in good condition is not a hazard.
- FACT:** Removing lead-based paint improperly can increase the danger to your family.

If you think your home might have lead hazards, read this pamphlet to learn some simple steps to protect your family.

Lead Gets in the Body in Many Ways

In the United States, about 900,000 children ages 1 to 5 have a blood-lead level above the level of concern.

Even children who appear healthy can have dangerous levels of lead in their bodies.

People can get lead in their body if they:

- ◆ Put their hands or other objects covered with lead dust in their mouths.
- ◆ Eat paint chips or soil that contains lead.
- ◆ Breathe in lead dust (especially during renovations that disturb painted surfaces).

Lead is even more dangerous to children than adults because:

- ◆ Babies and young children often put their hands and other objects in their mouths. These objects can have lead dust on them.
- ◆ Children's growing bodies absorb more lead.
- ◆ Children's brains and nervous systems are more sensitive to the damaging effects of lead.

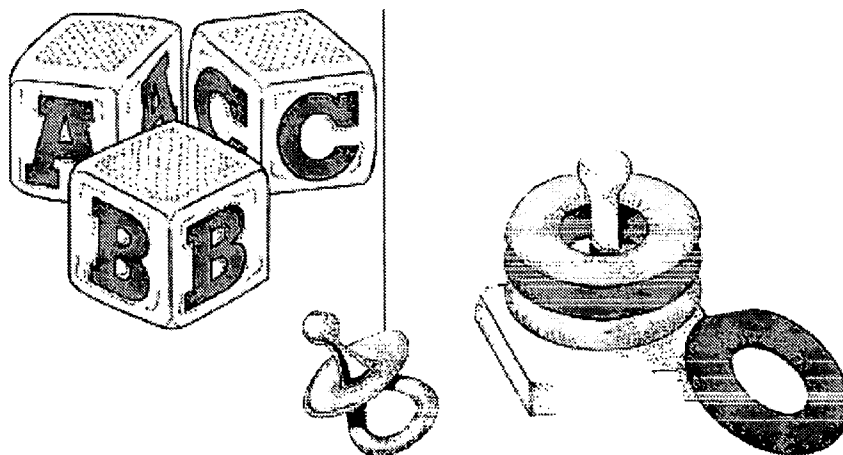

Lead's Effects

If not detected early, children with high levels of lead in their bodies can suffer from:

- ◆ Damage to the brain and nervous system
- ◆ Behavior and learning problems (such as hyperactivity)
- ◆ Slowed growth
- ◆ Hearing problems
- ◆ Headaches

Lead is also harmful to adults. Adults can suffer from:

- ◆ Difficulties during pregnancy
- ◆ Other reproductive problems (in both men and women)
- ◆ High blood pressure
- ◆ Digestive problems
- ◆ Nerve disorders
- ◆ Memory and concentration problems
- ◆ Muscle and joint pain

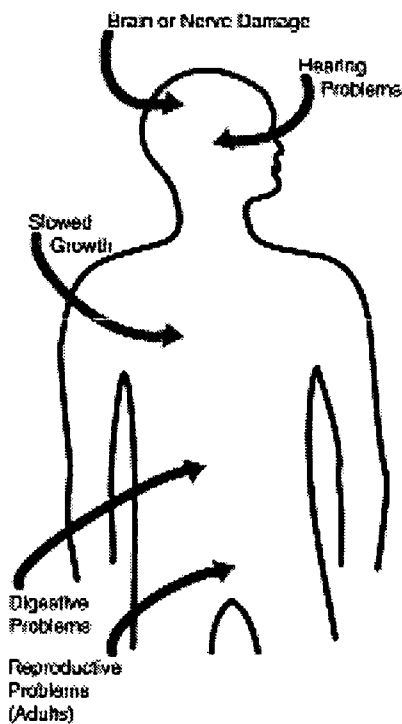

***Lead affects
the body in
many ways.***

Where Lead-Based Paint Is Found

In general, the older your home, the more likely it has lead-based paint.

Many homes built before 1978 have lead-based paint. The federal government banned lead-based paint from housing in 1978. Some states stopped its use even earlier. Lead can be found:

- ◆ In homes in the city, country, or suburbs.
- ◆ In apartments, single-family homes, and both private and public housing.
- ◆ Inside *and* outside of the house.
- ◆ In soil around a home. (Soil can pick up lead from exterior paint or other sources such as past use of leaded gas in cars.)

Checking Your Family for Lead

Get your children and home tested if you think your home has high levels of lead.

To reduce your child's exposure to lead, get your child checked, have your home tested (especially if your home has paint in poor condition and was built before 1978), and fix any hazards you may have.

Children's blood lead levels tend to increase rapidly from 6 to 12 months of age, and tend to peak at 18 to 24 months of age.

Consult your doctor for advice on testing your children. A simple blood test can detect high levels of lead. Blood tests are usually recommended for:

- ◆ Children at ages 1 and 2.
- ◆ Children or other family members who have been exposed to high levels of lead.
- ◆ Children who should be tested under your state or local health screening plan.

Your doctor can explain what the test results mean and if more testing will be needed.

Where Lead Is Likely To Be a Hazard

Lead-based paint that is in good condition is usually not a hazard.

Peeling, chipping, chalking, or cracking lead-based paint is a hazard and needs immediate attention.

Lead-based paint may also be a hazard when found on surfaces that children can chew or that get a lot of wear-and-tear. These areas include:

- ◆ Windows and window sills.
- ◆ Doors and door frames.
- ◆ Stairs, railings, and banisters.
- ◆ Porches and fences.

Lead dust can form when lead-based paint is dry scraped, dry sanded, or heated. Dust also forms when painted surfaces bump or rub together. Lead chips and dust can get on surfaces and objects that people touch. Settled lead dust can re-enter the air when people vacuum, sweep, or walk through it.

Lead in soil can be a hazard when children play in bare soil or when people bring soil into the house on their shoes. Call your state agency (see page 11) to find out about testing soil for lead.

Lead from paint chips, which you can see, and lead dust, which you can't always see, can both be serious hazards.

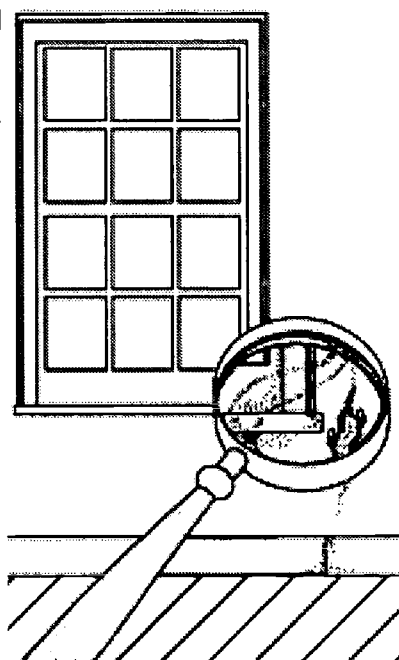

Checking Your Home for Lead Hazards

Just knowing that a home has lead-based paint may not tell you if there is a hazard.

You can get your home checked for lead hazards in one of two ways, or both:

- ◆ A paint **inspection** tells you the lead content of every different type of painted surface in your home. It won't tell you whether the paint is a hazard or how you should deal with it.
- ◆ A **risk assessment** tells you if there are any sources of serious lead exposure (such as peeling paint and lead dust). It also tells you what actions to take to address these hazards.

Have qualified professionals do the work. *There are standards in place for certifying lead-based paint professionals to ensure the work is done safely, reliably, and effectively.* Contact your state lead poisoning prevention program for more information. Call 1-800-424-LEAD for a list of contacts in your area.

Trained professionals use a range of methods when checking your home, including:

- ◆ Visual inspection of paint condition and location.
- ◆ A portable x-ray fluorescence (XRF) machine.
- ◆ Lab tests of paint samples.
- ◆ Surface dust tests.

Home test kits for lead are available, but studies suggest that they are not always accurate. Consumers should not rely on these tests before doing renovations or to assure safety.

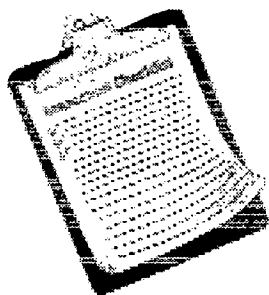

What You Can Do Now To Protect Your Family

If you suspect that your house has lead hazards, you can take some immediate steps to reduce your family's risk:

- ◆ If you rent, notify your landlord of peeling or chipping paint.
- ◆ Clean up paint chips immediately.
- ◆ Clean floors, window frames, window sills, and other surfaces weekly. Use a mop or sponge with warm water and a general all-purpose cleaner or a cleaner made specifically for lead. REMEMBER: NEVER MIX AMMONIA AND BLEACH PRODUCTS TOGETHER SINCE THEY CAN FORM A DANGEROUS GAS.
- ◆ Thoroughly rinse sponges and mop heads after cleaning dirty or dusty areas.
- ◆ Wash children's hands often, especially before they eat and before nap time and bed time.
- ◆ Keep play areas clean. Wash bottles, pacifiers, toys, and stuffed animals regularly.
- ◆ Keep children from chewing window sills or other painted surfaces.
- ◆ Clean or remove shoes before entering your home to avoid tracking in lead from soil.
- ◆ Make sure children eat nutritious, low-fat meals high in iron and calcium, such as spinach and dairy products. Children with good diets absorb less lead.

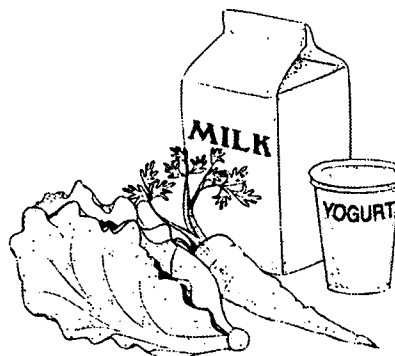
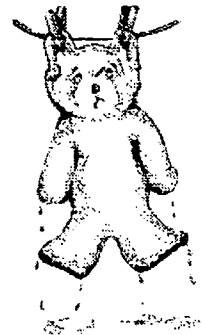

How To Significantly Reduce Lead Hazards

Removing lead improperly can increase the hazard to your family by spreading even more lead dust around the house.

Always use a professional who is trained to remove lead hazards safely.

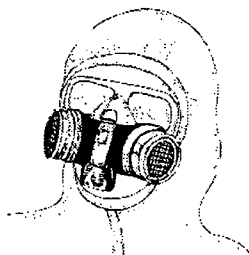

In addition to day-to-day cleaning and good nutrition:

- ◆ You can **temporarily** reduce lead hazards by taking actions such as repairing damaged painted surfaces and planting grass to cover soil with high lead levels. These actions (called "interim controls") are not permanent solutions and will need ongoing attention.
- ◆ To **permanently** remove lead hazards, you must hire a certified lead "abatement" contractor. Abatement (or permanent hazard elimination) methods include removing, sealing, or enclosing lead-based paint with special materials. Just painting over the hazard with regular paint is not enough.

Always hire a person with special training for correcting lead problems—someone who knows how to do this work safely and has the proper equipment to clean up thoroughly. Certified contractors will employ qualified workers and follow strict safety rules as set by their state or by the federal government.

Call your state agency (see page 11) for help with locating certified contractors in your area and to see if financial assistance is available.

Remodeling or Renovating a Home With Lead-Based Paint

Take precautions before your contractor or you begin remodeling or renovations that disturb painted surfaces (such as scraping off paint or tearing out walls):

- ◆ **Have the area tested for lead-based paint.**
- ◆ **Do not use a belt-sander, propane torch, heat gun, dry scraper, or dry sandpaper** to remove lead-based paint. These actions create large amounts of lead dust and fumes. Lead dust can remain in your home long after the work is done.
- ◆ **Temporarily move your family** (especially children and pregnant women) out of the apartment or house until the work is done and the area is properly cleaned. If you can't move your family, at least completely seal off the work area.
- ◆ **Follow other safety measures to reduce lead hazards.** You can find out about other safety measures by calling 1-800-424-LEAD. Ask for the brochure "Reducing Lead Hazards When Remodeling Your Home." This brochure explains what to do before, during, and after renovations.

If you have already completed renovations or remodeling that could have released lead-based paint or dust, get your young children tested and follow the steps outlined on page 7 of this brochure.

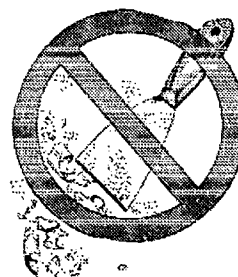

If not conducted properly, certain types of renovations can release lead from paint and dust into the air.

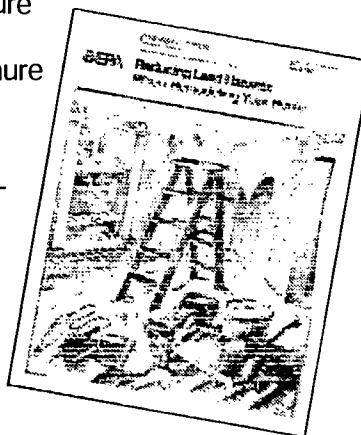

Other Sources of Lead

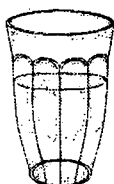

While paint, dust, and soil are the most common lead hazards, other lead sources also exist.

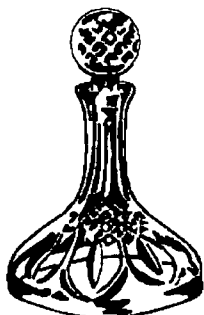
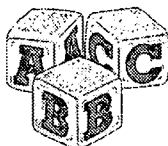

◆ **Drinking water.** Your home might have plumbing with lead or lead solder. Call your local health department or water supplier to find out about testing your water. You cannot see, smell, or taste lead, and boiling your water will not get rid of lead. If you think your plumbing might have lead in it:

- Use only cold water for drinking and cooking.
- Run water for 15 to 30 seconds before drinking it, especially if you have not used your water for a few hours.

◆ **The job.** If you work with lead, you could bring it home on your hands or clothes. Shower and change clothes before coming home. Launder your work clothes separately from the rest of your family's clothes.

◆ **Old painted toys and furniture.**

◆ **Food and liquids stored in lead crystal or lead-glazed pottery or porcelain.**

◆ **Lead smelters** or other industries that release lead into the air.

◆ **Hobbies** that use lead, such as making pottery or stained glass, or refinishing furniture.

◆ **Folk remedies** that contain lead, such as "greta" and "azarcon" used to treat an upset stomach.

For More Information

The National Lead Information Center

Call **1-800-424-LEAD** to learn how to protect children from lead poisoning and for other information on lead hazards. (Internet: **www.epa.gov/lead** and **www.hud.gov/lea**).

For the hearing impaired, call the Federal Information Relay Service at **1-800-877-8339** and ask for the National Lead Information Center at **1-800-424-LEAD**.

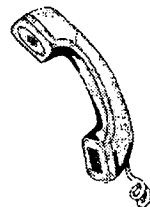

EPA's Safe Drinking Water Hotline

Call **1-800-426-4791** for information about lead in drinking water.

Consumer Product Safety Commission Hotline

To request information on lead in consumer products, or to report an unsafe consumer product or a product-related injury call **1-800-638-2772**. (Internet: www@cpsc.gov). For the hearing impaired, call **TDD 1-800-638-8270**.

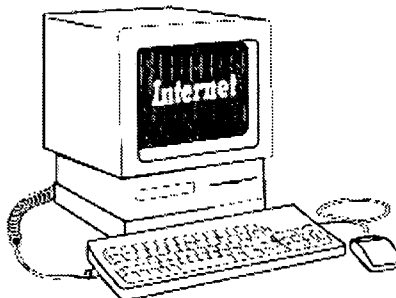

State Health and Environmental Agencies

Some cities and states have their own rules for lead-based paint activities. Check with your state agency to see if state or local laws apply to you. Most state agencies can also provide information on finding a lead abatement firm in your area, and on possible sources of financial aid for reducing lead hazards. Receive up-to-date address and phone information for state and local contacts on the Internet at **www.epa.gov/lead** or contact the National Lead Information Center at **1-800-424-LEAD**.

EPA Regional Offices

Your Regional EPA Office can provide further information regarding regulations and lead protection programs.

EPA Regional Offices

Region 1 (Connecticut, Massachusetts, Maine, New Hampshire, Rhode Island, Vermont)

Regional Lead Contact
U.S. EPA Region 1
Suite 1100 (CPT)
One Congress Street
Boston, MA 02114-2023
1 (888) 372-7341

Region 2 (New Jersey, New York, Puerto Rico, Virgin Islands)

Regional Lead Contact
U.S. EPA Region 2
2890 Woodbridge Avenue
Building 209, Mail Stop 225
Edison, NJ 08837-3679
(732) 321-6671

Region 3 (Delaware, Washington DC, Maryland, Pennsylvania, Virginia, West Virginia)

Regional Lead Contact
U.S. EPA Region 3 (3WC33)
1650 Arch Street
Philadelphia, PA 19103
(215) 814-5000

Region 4 (Alabama, Florida, Georgia, Kentucky, Mississippi, North Carolina, South Carolina, Tennessee)

Regional Lead Contact
U.S. EPA Region 4
61 Forsyth Street, SW
Atlanta, GA 30303
(404) 562-8998

Region 5 (Illinois, Indiana, Michigan, Minnesota, Ohio, Wisconsin)

Regional Lead Contact
U.S. EPA Region 5 (DT-8J)
77 West Jackson Boulevard
Chicago, IL 60604-3666
(312) 886-6003

Region 6 (Arkansas, Louisiana, New Mexico, Oklahoma, Texas)

Regional Lead Contact
U.S. EPA Region 6
1445 Ross Avenue, 12th Floor
Dallas, TX 75202-2733
(214) 665-7577

Region 7 (Iowa, Kansas, Missouri, Nebraska)

Regional Lead Contact
U.S. EPA Region 7
(ARTD-RALI)
901 N. 5th Street
Kansas City, KS 66101
(913) 551-7020

Region 8 (Colorado, Montana, North Dakota, South Dakota, Utah, Wyoming)

Regional Lead Contact
U.S. EPA Region 8
999 18th Street, Suite 500
Denver, CO 80202-2466
(303) 312-6021

Region 9 (Arizona, California, Hawaii, Nevada)

Regional Lead Contact
U.S. Region 9
75 Hawthorne Street
San Francisco, CA 94105
(415) 744-1124

Region 10 (Idaho, Oregon, Washington, Alaska)

Regional Lead Contact
U.S. EPA Region 10
Toxics Section WCM-128
1200 Sixth Avenue
Seattle, WA 98101-1128
(206) 553-1985

CPSC Regional Offices

Your Regional CPSC Office can provide further information regarding regulations and consumer product safety.

Eastern Regional Center

6 World Trade Center
Vesey Street, Room 350
New York, NY 10048
(212) 466-1612

Western Regional Center

600 Harrison Street, Room 245
San Francisco, CA 94107
(415) 744-2966

Central Regional Center

230 South Dearborn Street
Room 2944
Chicago, IL 60604-1601
(312) 353-8260

HUD Lead Office

Please contact HUD's Office of Lead Hazard Control for information on lead regulations, outreach efforts, and lead hazard control and research grant programs.

U.S. Department of Housing and Urban Development

Office of Lead Hazard Control
451 Seventh Street, SW, P-3206
Washington, DC 20410
(202) 755-1785

Simple Steps To Protect Your Family From Lead Hazards

If you think your home has high levels of lead:

- ◆ Get your young children tested for lead, even if they seem healthy.
- ◆ Wash children's hands, bottles, pacifiers, and toys often.
- ◆ Make sure children eat healthy, low-fat foods.
- ◆ Get your home checked for lead hazards.
- ◆ Regularly clean floors, window sills, and other surfaces.
- ◆ Wipe soil off shoes before entering house.
- ◆ Talk to your landlord about fixing surfaces with peeling or chipping paint.
- ◆ Take precautions to avoid exposure to lead dust when remodeling or renovating (call 1-800-424-LEAD for guidelines).
- ◆ Don't use a belt-sander, propane torch, heat gun, dry scraper, or dry sandpaper on painted surfaces that may contain lead.
- ◆ Don't try to remove lead-based paint yourself.

Recycled/Recyclable

Printed on paper that contains at least 20 percent postconsumer fiber.

APPENDIX 4

Information About Lead-Based Paint Pre-Renovation Education Rule

Lead Pre-Renovation Education Rule flyer

**Lead-Based Paint Pre-Renovation Regulation
Tri-fold Pamphlet**

**Pre-Renovation Lead Information Rule:
Questions and Answers**

Pre-Renovation Lead Information Rule: Fact Sheet

**Lead-Based Paint Pre-Renovation Education Rule:
Handbook**

**Lead-Based Paint Pre-Renovation Education Rule:
Interpretative Guidance Part 1**

**Lead-Based Paint Pre-Renovation Education Rule:
Interpretative Guidance Correction to Part 1**

**Lead-Based Paint Pre-Renovation Education Rule:
Interpretative Guidance Part 2**

ATTENTION!

Remodeler/Renovator/Contractor/Landlord Does the New Federal Lead-Based Paint Regulation Apply to You?

- Yes, if:
- Your work involves pre-1978 houses or apartments
 - You receive any form of compensation for your work
 - You disturb more than 2 square feet of painted surfaces
 - Your work is not specifically excluded from this law

Federal law requires distribution of this lead hazard information pamphlet **BEFORE** starting a renovation. →

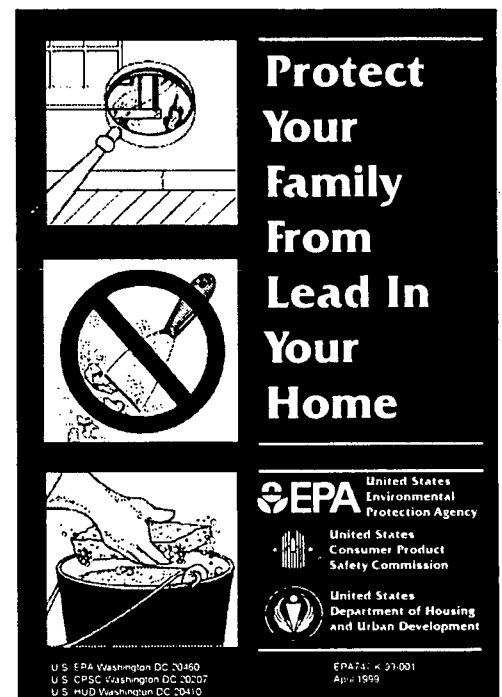

Applicable to:

- Carpenters
- Home Improvement Contractors
- Renovators & Remodelers
- Landlords/Property Managers
- Electricians & Plumbers
- Apartment Maintenance Staff
- Painters
- Anyone whose work disturbs paint

Find Out More on How to Comply

Information on back



U.S. Environmental Protection Agency
EPA 747-F-00-002
March 2000

1-800-424-LEAD
www.epa.gov/lead



The Lead Pre-Renovation Education (PRE) Rule

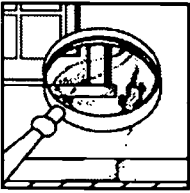

In general, the Lead PRE Rule applies to:
Renovations performed in pre-1978 housing which are performed for compensation.

“**Renovation**” means any modification of all or part of any existing structure in the housing that disturbs painted surfaces. “Renovation” includes:

- Removal/modification of painted surfaces, components, or structures
- Surface preparation activities (sanding/scraping/ other activities that may create paint dust)
- Window replacement.

“**Compensation**” is the receipt of anything of value (not only money), and may include:

- Exchanges of money, goods, or services
- Payment of rent to landlords/property managers.

Renovation Examples:

- Demolition of painted walls or ceilings
- Large surface replastering
- Major plumbing repairs or improvements
- Any other activities which disturb more than 2 square feet of painted surfaces

Are there exemptions from these requirements? YES...



- Lead abatement activities performed by certified lead abatement contractors
- Emergency renovations
- Renovation of certified lead-based paint free components
- Minor repair/maintenance activities which disturb less than 2 square feet of painted surfaces
- Renovations in dormitories/studio apartments/housing for the elderly or disabled

What am I required to do? Specific requirements depend on the following criteria:

In owner-occupied housing you must:

- Provide an EPA-approved lead information pamphlet to owner and get written acknowledgment or receipt from owner, OR
- Mail the pamphlet to owner 7 days prior to renovation and document with certificate of mailing.

In tenant-occupied housing you must:

- Provide an EPA-approved pamphlet to both building owner and an adult occupant by one of above methods.
- if attempted delivery to adult occupant fails, you may comply by leaving the pamphlet at unit and preparing certification describing delivery attempts for your files.

For renovations in “common areas” in multi-family housing (more than 4 units), you must:

- Provide an EPA-approved pamphlet by one of the methods listed under owner-occupied housing above.
- Provide notice to each tenant in the building describing:
 - Nature/location/timing of renovation.
 - Availability of the EPA-approved pamphlet (free upon request).
- Retain written documentation describing notification procedures for 3 years.



For more information or to obtain lead hazard information pamphlets:

1-800-424-LEAD

www.epa.gov/lead

Region 1 (CT, MA, ME, NH, RI, VT)
1 Congress Street
Suite 1100 (CPT)
Boston, MA 02114 888-372-7341

Region 2 (NJ, NY, PR, VI)
MS-225
2890 Woodbridge Avenue
Edison, NJ 08837 732-321-6671

Region 3 (DE, DC, MD, PA, VA, WV)
1650 Arch Street
Philadelphia, PA 19103 215-814-5000

Region 4 (AL, FL, GA, KY, MS, NC, SC, TN)
Sam Nunn AFC Tower
12th Floor, 61 Forsyth Street
Atlanta, GA 30303 404-562-8989

Region 5 (IL, IN, MI, MN, OH, WI)
77 West Jackson Blvd.
Chicago, IL 60604 312-886-6003

Region 6 (AR, LA, NM, OK, TX)
First Interstate Bank Tower
1445 Ross Avenue
12th Floor, Suite 1200
Dallas, TX 75202 800-887-6063

Region 7 (IA, KS, MO, NE)
901 N. 5th Street
Kansas City, KS 66101 913-551-7020

Region 8 (CO, MT, ND, SD, UT, WY)
999 18th Street, Suite 500
Denver, CO 80202 303-312-6021

Region 9 (AZ, CA, HI, NV)
75 Hawthorne Street
San Francisco, CA 94105 415-744-1124

Region 10 (ID, OR, WA, AK)
1200 Sixth Avenue, WCM-128
Seattle, WA 98101 206-553-1985



The Lead-Based Paint Pre-Renovation Regulation: Does It Apply to YOU?

- Home Improvement Contractors
- Landlords/Property Managers
- Apartment Maintenance Staff
- Renovators & Remodelers
- Electricians & Plumbers
- Painters
- Carpenters
- Anyone whose work disturbs paint

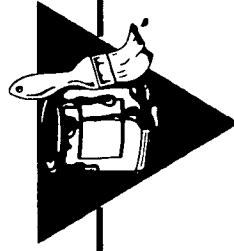

United States
Environmental Protection Agency
(7404)
Washington, DC 20460
Official Business
Penalty for Private Use \$300



What is the Lead-Based Paint Pre-Renovation Education Rule (Lead PRE)?

- Lead PRE is a Federal regulation affecting renovations/repairs in residential housing built before 1978.
- Lead PRE is designed to provide residents of pre-1978 housing with information to help prevent lead exposure which can cause serious health effects, especially in children and pregnant women.

Who Must Follow These Requirements?

- In general, anyone whose compensated work disturbs paint in housing built before 1978, including:
- Residential rental property owners/managers
 - General contractors
 - Special trade contractors, including: Painters, Plumbers, Carpenters, Electricians.

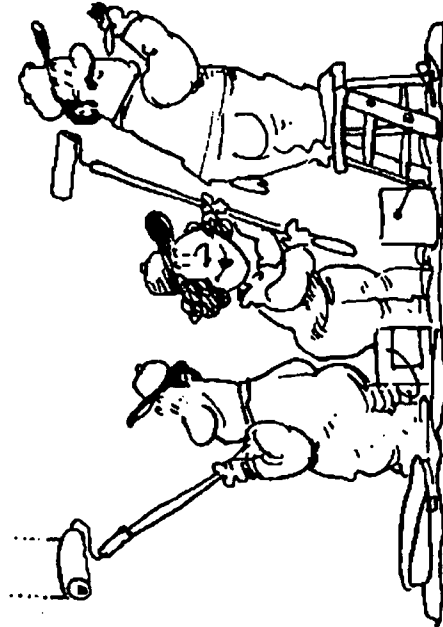

BEST COPY AVAILABLE

Generally, the New Lead PRE Rule Applies to YOU if:

- Your renovation/repair work involves houses/apartments built before 1978.
- You disturb more than 2 square feet of painted surfaces.
- You are compensated for the work, do the work in exchange for other services (bartering), or you or your staff do the work as property managers.
- Your work is not specifically excluded from this law.







Protect Your Family From Lead In Your Home



United States
Environmental
Protection Agency



United States
Consumer Product
Safety Commission



United States
Department of Housing
and Urban Development

EPA 310 (9/78)
U.S. GPO: 1978-0-250-300
U.S. GOVERNMENT PRINTING OFFICE: 1978

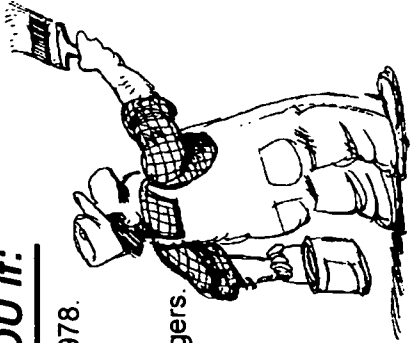

What Does Lead PRE Require You to Do?

For work in houses or individual apartments:

- Distribute the pamphlet, *Protect Your Family From Lead in Your Home*, to housing owners and occupants before starting renovations or repairs, AND
- Obtain confirmation of receipt of this pamphlet from owner and occupants (OR you may mail the pamphlet and obtain a certificate of mailing from the post office), AND
- Retain records for 3 years.

For work in common areas of multi-family housing:

- Distribute renovation notices to tenants.
- Retain records for 3 years.

What Work is Specifically Excluded from Lead PRE?

- Housing built in 1978 or later
- Housing for the elderly or disabled persons (unless children will reside there)
- Zero-bedroom dwellings (studio apartments, dormitories, etc.)
- Housing or components declared lead-free by a certified lead inspector or certified risk assessor
- Emergency renovations and repairs
- Minor repairs and maintenance that disturb 2 square feet or less of paint per component

To find out more about Lead PRE or to obtain the Protect Your Family From Lead pamphlet:

CALL: 1-800-424-LEAD
VISIT: www.epa.gov/lead
CONTACT: Your EPA Regional Office

EPA Questions and Answers

Pre-Renovation Lead Information Rule (TSCA 406B)

Following the questions and answers are several example scenarios.

Q: What is the Pre-Renovation Lead Information rule?

A: The Pre-Renovation Lead Information Rule (PLIR), also known as section 406(b) of the Toxic Substances Control Act, is a rule requiring people performing renovation for compensation to distribute a lead hazard information pamphlet prior to commencing the renovation.

Q: Why is the Pre-Renovation Lead Information rule necessary?

A: Through Title IV of the Toxic Substances Control Act, Congress directed EPA to address the public's risk of exposure to lead-based paint hazards through regulations, education, and other activities. Of particular concern to Congress were potential lead exposure risks that could occur during renovations of housing containing lead-based paint.

Congress believed that informed owners and occupants of housing slated for renovation could act to avoid lead exposure to themselves and their families. So Congress directed EPA to:

- create a lead hazard information pamphlet containing information on lead-based paint in housing, the risks of exposure, and the precautions for avoiding exposure
- issue PLIR so that compensated renovators would distribute the pamphlet to owners and occupants of most pre-1978 residential housing before beginning renovations

Q: Does the Pre-Renovation Lead Information rule apply to me?

A: If your job is for compensation and will require you to disturb more than 2ft² of paint in pre-1978 housing, then you are a renovator for the purposes of PLIR. This is not dependent upon whether what you do is typically considered a renovation. Whether you are a plumber, a drywaller, a painter, or an electrician, if your job requires that you disturb more than 2ft² of paint, then you must comply with PLIR.

The term compensation extends beyond money. Providing services in exchange for other services (e.g., bartering) is included within the term. PLIR applies to owners renovating their own apartment buildings using maintenance staff as well as neighborhood handymen providing services to those in the neighborhood for services or goods other than money.

Work that is performed for free (e.g., no exchange of money, goods, or services) or work performed by Do-It-Yourselfers in their own homes is not covered by PLIR. Work that is performed during an emergency (i.e., a hazardous, non-routine situation that could either threaten public health or cause substantial property damage) is also excluded from this rule.

Q: What exactly do I have to do if the Lead Pamphlet Distribution rule applies to me?

A: If you are performing a renovation in pre-1978 housing and that renovation will disturb more than 2 ft² of paint, then you must give the owner of the housing a copy of the pamphlet and get her acknowledgment of receipt. If the housing is tenant occupied, then in addition to giving a copy of the pamphlet to the owner, you must provide a copy to the tenant and get her signature as well. The same requirements apply to apartments in housing with more than four separate dwelling units.

If the renovation is to occur in a common area (e.g., laundry room, hallway, playground) of housing with more than four separate dwelling units, you must provide all residents of the building information on the timing and extent of the renovations slated to occur.

Q: How do I get copies of the pamphlet?

A: The pamphlet has been made available to the general public as well as the regulated community. Single copies of the pamphlet are available in both English and Spanish from the NLIC, by calling 1-800-424-LEAD. Multiple copies are available through the Government Printing Office (GPO), and may be ordered by calling the GPO Order Desk at (202) 512-1800, faxing (202) 512-2233, or writing to Superintendent of Documents, P.O. Box 371954, Pittsburgh, PA 15250-7954. Request the publication by title, Protect Your Family From Lead in Your Home, and/or GPO stock #055-000-00507-9.

Q: When do I have to start complying with the Lead Pamphlet Distribution rule?

A: PLIR is effective one year after the date of publication.

Q: What if the tenant or owner won't accept or isn't home to accept the pamphlet?

A: If the tenant or owner refuses or is unavailable to accept the pamphlet, PLIR allows for the renovator to certify the attempt. PLIR also allows the renovator to mail the pamphlet (at least 7 days prior to the renovation) if she purchases a certificate of mailing from the Post Office when mailing the pamphlet.

PRE-RENOVATION INFORMATION RULE EXAMPLES

The following scenarios are designed to facilitate your understanding of how the Pre-Renovation Information Rule (PLIR- also known as the Toxic Substances Control Act (TSCA) §406(b) rule) requirements are likely to be met by regulated parties.

Background

Jane General-Contractor has four impending contracts. One contract is for the re-shingling of the roof and re-painting of the exterior of a home. One contract is for the renovation of the interiors and shared entry-way foyer of a "duplex" (two separate dwelling units, typically one over the other, that occupy a single residential structure). Another contract is for the renovation of several apartments and the re-painting of the outdoor playground equipment of a large apartment building. The last contract is for the renovation of several apartments in a small, six-unit apartment building. Jane is aware of PLIR and plans to take the affirmative steps necessary to comply with the law.

Example 1 - The Home Renovation

The first step that Jane takes is to determine whether PLIR is applicable to this job. Based upon a brief examination of her plans and a brief telephone discussion with the home owner, Jane knows:

- The re-painting will disturb more than 2 ft² of exterior paint
- The house was built in 1930
- The house exterior has not been inspected by a certified inspector
- This is not an “emergency” renovation

During a meeting to discuss the plans and costs with the homeowner, Jane gives the owner the lead hazard information pamphlet. The homeowner signs a certification of pamphlet receipt (modeled on the sample language in PLIR) that Jane has added to her contracts. Jane returns to her office and files the certification, aware that the certification must be retained for three years. Jane has met the PLIR requirements.

Example 2 - The Duplex Renovation

As described in Example 1, Jane acts to determine whether PLIR is applicable to this job. Based upon a brief examination of her renovation plans and a brief telephone discussion with the owner, Jane knows:

- The renovation is likely to disturb more than 2ft² of paint inside dwelling unit 1
- The renovation will not disturb any paint inside dwelling unit 2
- The renovation will disturb more than 2ft² of the shared foyer paint
- The duplex was built in the 1950's
- The duplex has not been inspected by a certified inspector
- This is not an “emergency” renovation
- The owner does not live in the duplex
- The dwelling units in the duplex are rented to two families

During a meeting to discuss the plans and costs with the duplex owner, Jane gives the owner the lead hazard information pamphlet. The duplex owner then signs a certification of pamphlet receipt (modeled on the sample language in PLIR) that Jane has added to her contracts. Jane files the certification.

A few days before the renovation, Jane sends an employee over to the duplex to take a few foyer measurements. She also directs the employee to deliver a lead hazard information pamphlet to an adult occupant of duplex unit 1 and gives him a checklist, a lead hazard information pamphlet, and a pamphlet receipt certification form.

The employee knocks on the door of duplex unit 1 and a child answers the door. After ascertaining that no adult is home, the employee slips the pamphlet under the door and makes note of the address, date, time, and that the pamphlet was delivered when only a child was present. That information is later used by Jane or the employee to complete a certification that a pamphlet was delivered to duplex unit 1 but that an acknowledgment could not be obtained due to the lack of an adult occupant at the time of delivery. Jane puts this certification in her filing cabinet.

Jane knows that she does not have to notify the duplex residents about the activities in the shared foyer of the duplex because the “common area” notification requirements are only applicable to a building with more than four dwelling units. Jane also knows that she does not have to provide a pamphlet to an occupant of duplex unit 2 because no paint will be disturbed. Jane is aware that she must retain the filed certifications for three years. Jane has met the PLIR requirements.

Example 3 - The Large Apartment Building Renovation

As described in Example 1, Jane determines whether PLIR is applicable to this job. Based upon a brief examination of her renovation plans and a brief telephone discussion with the owner, Jane knows:

- The apartment renovations are likely to disturb more than 2ft² of paint
- The re-painting of the playground equipment may disturb more than 2ft² of paint
- The building was built before 1969
- Neither the apartments nor the playground equipment have been inspected by a certified inspector
- This is not an “emergency” renovation

During a meeting to discuss the plans and cost with the building owner, Jane gives the building owner the lead hazard information pamphlet. The building owner then signs a certification of pamphlet receipt (modeled on the sample language in PLIR) that Jane has added to her contracts.

Jane is aware of the fact that the playground is an apartment building common area. A few days before the scheduled re-painting of the playground equipment, Jane gives two employees several pamphlets and a stack of notices containing information on the general nature, location, and start/end dates of the re-painting. Jane, in creating the notices with a generous time line, has purposefully allowed for work delays. The notices also indicate that copies of the lead hazard information pamphlet can be obtained at the building’s management office. Jane directs the employees to “shove” a notice under the door of each apartment in the building. Jane further directs the employees to leave the pamphlets with the secretary of the owner’s on-site management office (per an agreement between Jane and the owner). After the employees return, Jane certifies a basic description of the steps taken to notify the residents about the playground re-painting activity.

Jane arranges that her secretary send a pamphlet to each to-be-renovated apartment via certificate of mailing at least a week before renovation begins. The secretary accomplishes this by working with the on-site foreman to track renovation progress in the preceding units. Ten days before the renovations are scheduled to begin in each unit, the secretary goes to the Post Office, and mails a pamphlet by purchasing a certificate of mailing from the teller,

Jane puts the common area certification and the certificate of mailing receipts in her filing cabinet, fully aware that they must be retained for three years. Jane has met the PLIR requirements.

Example 4 - The Small Apartment Building Renovation

As described in Example 1, Jane determines whether PLIR is applicable to this job. Based upon a brief examination of her renovation plans and a brief telephone discussion with the owner, Jane knows:

- The apartment renovations are likely to disturb more than 2ft² of paint
- The building was built in 1987
- This is not an “emergency” renovation

Jane correctly concludes that because the building was built after 1978, PLIR is not applicable.



FACT SHEET

EPA Releases Final Rule Requiring Distribution of Lead Hazard Information Prior to Renovations

ACTION

A new EPA regulation will require renovators, working for compensation, to distribute a pamphlet to owners and occupants of most housing built prior to 1978 before commencing renovation activity. The pamphlet, entitled *Protect Your Family From Lead In Your Home*, discusses ways in which individuals can protect themselves and their families from lead-based paint hazards.

The pre-renovation lead information rule differentiates between renovation activities and excluded activities, such as routine maintenance or repair. Sanding, scraping, and other surface preparation activities that disrupt paint and generate dust are the two key sources of lead exposure during renovation.

Renovation activities that disrupt more than 2 square feet of paint per component will be covered by this rule. A general rule-of-thumb would be to include activities not specifically excluded in the rule, that disturb more than 2 square feet of a painted surface.

Specific exclusions include activities that are less likely to pose a risk of exposure to lead-based paint dust or other lead hazards. Prominent examples are minor housing repairs and maintenance activities, emergency renovation operations (specifically defined in the rule), and renovation activities that take place in housing that has already been determined by a certified inspector to be lead free.

The pre-renovation lead information rule will also require that before renovating common areas (e.g., hallways, stair wells) in multi-family housing, a renovator must inform building residents about the nature and extent of the renovations and make the pamphlet available in a central location.

LEGAL AUTHORITY

In an effort to protect families from exposure to the hazards of lead-based paint, Congress amended the *Toxic Substances Control Act (TSCA)* in 1992 to add Title IV, entitled *Lead Exposure Reduction*. Title IV of TSCA directs EPA to address the general public's risk of exposure to lead-based paint hazards through regulations, education, and other activities. One particular concern of Congress and EPA is the potential lead exposure risks that can occur during renovations of housing containing lead-based paint unless certain safety measures are taken.

Recognizing that many families might be unaware that their homes might contain lead-based paint, section 406(a) of TSCA directed EPA to publish, after notice and comment, a lead hazard information pamphlet providing comprehensive information to the general public on lead-based paint in housing, the risks of exposure, and the precautions for avoiding exposure. Section 406(b) of the law directed EPA to issue regulations requiring that compensated renovators distribute the pamphlet to owners and occupants of most pre-1978 residential housing before beginning renovations (1978 is the year that lead-based paint was banned from residential use).

PURPOSE

People have sometimes created a health hazard for their families without realizing it by disturbing surfaces containing lead-based paint during housing renovations. Activities like scraping, sanding, or using a heat gun on surfaces that contain lead-based paint can release large amounts of lead dust and fumes. Lead dust from renovations can remain in the home long after the work is completed.

EPA is promulgating this pre-renovation lead information rule to ensure that families are fully aware

of the importance of preventative measures to protect housing occupants before beginning renovations in housing that may contain lead-based paint.

LEAD HAZARDS IN HOUSING

Approximately three quarters of the nation's housing stock contains lead-based paint. When properly managed and maintained, this paint poses little risk. If improperly managed, however, lead from paint can threaten the health of occupants, especially children under 6 years of age. Over time, low-level exposure to lead from paint, dust, and soil can cause a range of health problems including permanent damage to the brain, nervous system and kidneys. In sufficient levels, lead can also cause health problem in adults. Because of its effects on fetal development, lead exposure can also be harmful to pregnant women and women of child-bearing age. Such exposure is largely preventable if individuals take precautionary measures.

PUBLIC COMMENT

EPA published a proposed section 406(b) rule in March 1994. Approximately 30 comments were received in response from such groups as associations representing builders and renovators, State and local health officials, and consumer advocacy groups. The final pre-renovation lead information rule will impose requirements on a large number of businesses and self-employed individuals. While this rule's requirements are minor, its effectiveness is dependent on the regulated community's understanding of their obligations.

LEAD HAZARD PAMPHLET

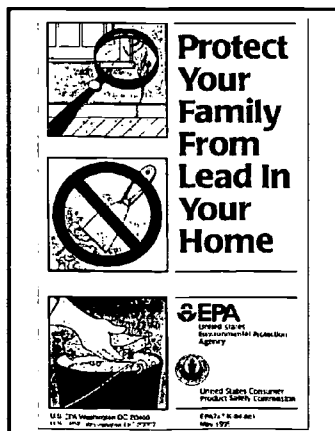

EPA developed a lead hazard information pamphlet entitled *Protect Your Family From Lead In Your Home*. This pamphlet provides families with prevention tips on reducing exposure to lead hazards from various sources.

EFFECTIVE DATE

June 1, 1999

FOR MORE INFORMATION

For a copy of *Protect Your Family from Lead in Your Home* (in English or Spanish) or the rule call the National Lead Information Center at 1-(800) 424-LEAD.

Bulk copies of the pamphlet are available from the Government Printing Office (GPO) at (202) 512-1800. Refer to the complete title or GPO Stock Number 055-000-00507-9. The price is \$26.00 for a pack of 50 copies. Alternatively, persons may reproduce the pamphlet, for use or distribution, providing that the text and graphics are reproduced in full. Camera-ready copies of the pamphlet are available from the National Lead Information Center.

For specific questions about lead-based paint and lead-based paint hazards, call the National Lead Information Center at 1-(800) 424-LEAD.

The EPA pamphlet and rule are available electronically and may be accessed through the Internet at the following URL: <http://www.epa.gov/lead>

The Lead-Based Paint Pre-Renovation Education Rule

A Handbook for Contractors, Property
Managers, and Maintenance Personnel

*Summary of Requirements Under
Section 406(b) of the Lead-Based Paint
Hazard Reduction Act of 1992*

INTERIM EDITION — JUNE 1999

**Prepared by the
Office of Pollution Prevention and Toxics
U.S. Environmental Protection Agency
Washington, D.C. 20460**

Note:

This Interim Edition of the handbook is being made available to increase public awareness and understanding of the rule requirements pending publication of the Final Edition of this handbook. While every effort has been made to make this handbook accurate and specific to individual circumstances, this handbook does not replace the definitive language of the official rule. Users are encouraged to obtain the official rule from the information sources described on page 6 of the handbook.

What Is The Lead-Based Paint Pre-Renovation Education Rule (Lead PRE)?

- The Lead PRE Rule is a Federal regulation affecting construction contractors, property managers, and others who perform **renovations** for **compensation** in residential housing that may contain lead-based paint.
- It applies to residential houses and apartments built before 1978.
- It requires distribution of the **lead pamphlet**, *Protect Your Family from Lead in Your Home*, to the owners and occupants before starting **renovation** work.
- **Renovation** includes most repair, remodeling, and maintenance activities that disturb painted surfaces.
- Lead PRE implements Section 406(b) of the Toxic Substances Control Act (TCSA).

About This Handbook

- This handbook summarizes Lead PRE and how to comply with it. To ensure compliance, you should also read the rule.
- Key terms are highlighted in **bold** and are explained on pages 8-10.

Who Should Read This Handbook?

- Anyone who owns or manages housing built before 1978.
- Contractors who perform **renovations** (including certain repairs and maintenance) which disturb paint in homes built before 1978.

How Can This Handbook Help Me?

- This handbook presents simple steps to follow to comply with Lead PRE. It also lists ways these steps can be easily incorporated into your work.
- Having demonstrated knowledge of lead requirements and safety practices can mean more business for you.
- Distributing the **lead pamphlet** to your customers and tenants can help them protect themselves and their children from the hazards of lead-based paint.
- This handbook describes the law. It also explains the proper steps to take to avoid potentially significant civil (monetary) and criminal fines and penalties.

What Does Lead PRE Require Me To Do?

1. Distribute a **lead pamphlet** to the housing **owner** and occupants before **renovation** starts.
2. Obtain **confirmation of receipt of lead pamphlet** (see page 11) from owner and occupants or a **certificate of mailing** from the post office.
3. For work in **common areas of multi-family housing**, distribute **renovation notices** to tenants.
4. Retain records for 3 years.

(See page 4 for more details)

Who Must Follow These Requirements?

In general, anyone whose compensated work disturbs paint in housing built before 1978, including:

- Residential rental property owners/managers
- **General contractors**
- **Special trade contractors**, including
 - Painters
 - Plumbers
 - Carpenters
 - Electricians

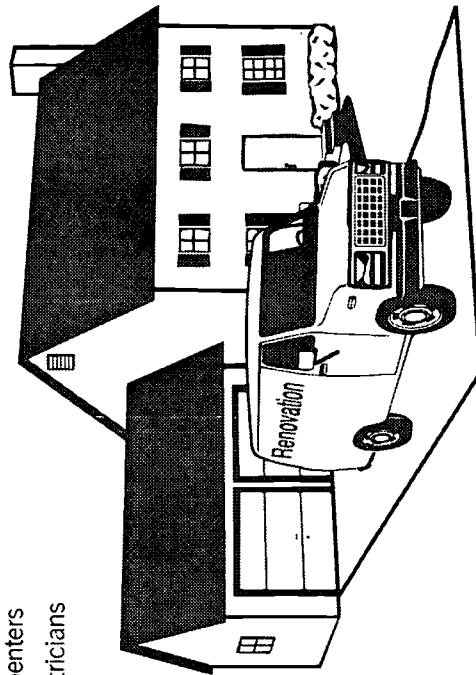

What Types Of Activities Are Subject To Lead PRE?

In general, any activity that disturbs paint in pre-1978 housing, including:

- Remodeling and repair/maintenance
- Plumbing
- Carpentry
- Electrical work
- Painting
- Window replacement

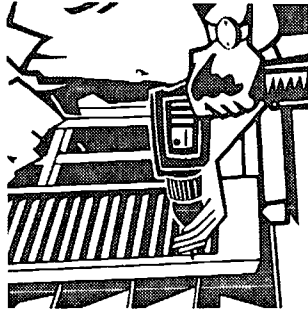
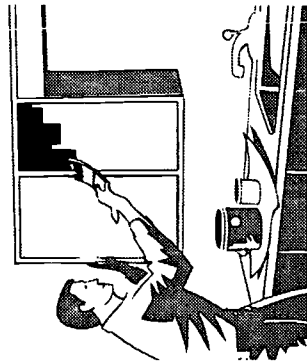

What Housing Or Activities Are Excluded From Lead PRE?

- Housing built in 1978 or later
- **Housing for the elderly** or disabled persons (unless children will reside there)
- **Zero-bedroom dwellings** (studio apartment, dormitories, etc.)
- Housing or **components** declared lead-free by a **certified inspector** or **risk assessor**
- **Emergency renovations** and repairs
- **Minor repairs and maintenance** that disturb two square feet or less of paint per component

Lead PRE At-A-Glance

If you will be working for **compensation** in a pre-1978 home or apartment building, answer the questions below to determine if Lead PRE requires you to give the **lead pamphlet** to the **owner** and occupants.

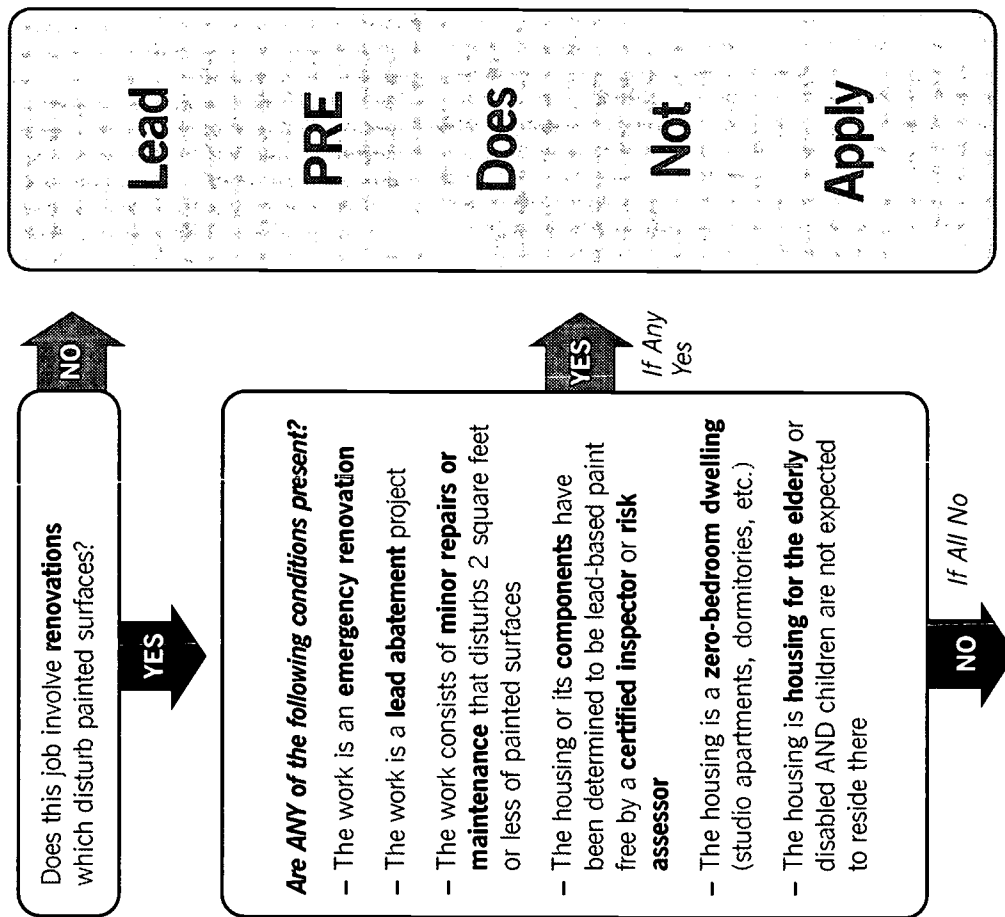

If no, then you need to provide the lead pamphlet (see page 4).

How Do I Meet The Lead PRE Requirements?

Renovation Location

Procedures to Follow

Box 1

Renovations in Owner-Occupied Dwelling Units

Deliver **lead pamphlet to owner** before renovation begins and obtain **confirmation of receipt**.

OR

Mail lead pamphlet to owner 7 days before renovation begins and document with **certificate of mailing** (sample form on page 11).

Box 2

Renovations in Tenant-Occupied Dwelling Units

1. Provide **lead pamphlet to owner** using either procedure described in Box 1 above.

2. Provide lead pamphlet to tenant by either method below:

(a) Deliver pamphlet to dwelling unit before **renovation** begins and document delivery with either a **confirmation of receipt** of lead pamphlet or a **self-certification of delivery**.

OR

(b) Mail lead pamphlet to tenant at least 7 days prior to renovation and document with a **certificate of mailing** (sample form on page 11).

Box 3

Renovations in Common Areas of Multi-Family Housing Units

1. Provide **owner** with **lead pamphlet** using either procedure described in Box 1 above.

2. Notify tenants and make pamphlet available.

3. Maintain written documentation describing notification procedures.

4. Provide **supplemental renovation notice** if changes occur in location, timing, or scope of renovation occurring.

Special Circumstances

Is painting considered renovation, even if no surface preparation activity occurs?

No. If the surface to be painted is not disturbed by sanding, scraping, or other activities that may cause dust, the work is not considered renovation and Lead PRE does not apply.

What if I renovate my own home?

Lead PRE applies only to renovations performed for compensation; therefore, if you work on your own home Lead PRE does not apply.

Is a renovation performed by a landlord or employees of a property management firm considered a compensated renovation under Lead PRE?

Yes. The receipt of rent payments or salaries derived from rent payments is considered compensation under Lead PRE. Therefore, renovation activities performed by landlords or employees of landlords are covered.

Do I have to give out the lead pamphlet 7 days prior to beginning renovation activities?

The 7-day advance delivery requirement applies only when you deliver the lead pamphlet via mail; otherwise, you may deliver the pamphlet anytime before the renovation begins. Note, however, that the renovation must begin within 60 days of the date that the pamphlet is delivered. So for example, if your renovation is to begin May 30, you may deliver the pamphlet in person anytime between April 1 and start of the project on May 30, or you may deliver the pamphlet via mail anytime between April 1 and May 23.

BEST COPY AVAILABLE

234



Tips For Easy Compliance

1. Copy and use the sample forms on pages 11 and 12 of this handbook.
2. Attach the forms to the back of your customer **renovation** or repair contracts. The completed forms can be filed along with your regular paperwork.
3. If a tenant is not home or refuses to sign the form, you may use the "self-certification" section of the form (on page 11) to prove delivery. This will reduce your paperwork.
4. Plan ahead to obtain enough copies of the **lead pamphlet**.

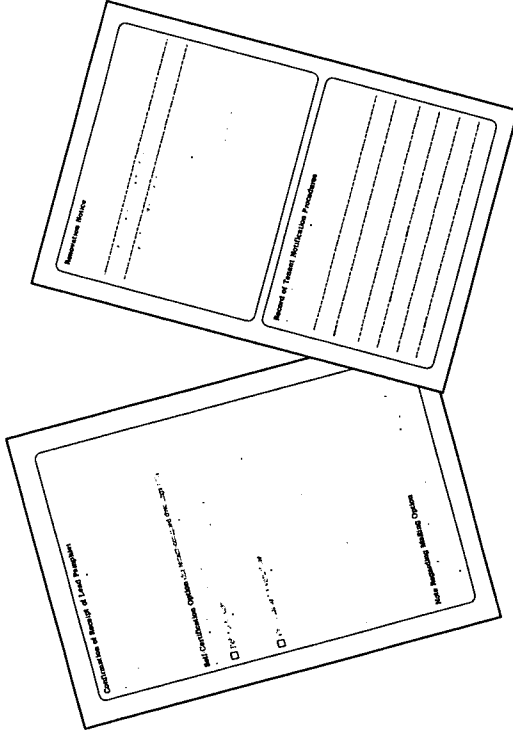

Where Can I Obtain More Information on Lead PRE?

- Further information is available from the National Lead Information Clearinghouse (800-424-LEAD) or through the Internet (www.epa.gov/lead). Available resources include:
- Full text version of Lead PRE
 - Interactive software which guides the users through the Lead PRE requirements on a step-by-step basis (available in late June)
 - Interpretive guidance which provides more detailed information on Lead PRE requirements

Why is Lead Paint Dangerous?

People can ingest lead by breathing or swallowing lead-based paint dust or by eating lead-contaminated soil or lead-based paint chips. Household animals are also at risk.

If not detected early, high levels of lead in a child can cause serious effects, including:

- Damage to the brain and nervous system
- Behavior and learning problems
- Slowed growth
- Hearing problems
- Headaches



Lead is also harmful to adults and can, among other effects, cause:

- Difficulties during pregnancy
- Other reproductive problems for men and women
- High blood pressure
- Digestive problems
- Nerve disorders
- Memory and concentration problems
- Muscle and joint pain

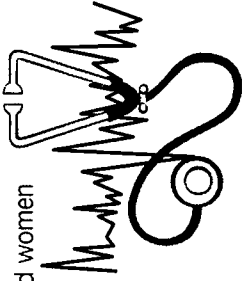

Lead can be dangerous to workers and their families if the worker brings equipment and clothing home after a job.

Other Resources

For additional information on how to protect yourself and your customers from lead paint hazards, call the National Lead Information Clearinghouse at 1-800-424-LEAD. Available documents include:

- *Lead-Based Paint: Operations and Maintenance Work Practices Manual for Homes and Buildings*
- *Lead Safety for Property Owners, Developers, and Managers*
- *Reducing Lead Hazards When Remodeling Your Home*
- *Lead in Your Home: A Parents' Reference Guide*
- *Lead Paint Safety: A Field Guide for Painting, Home Maintenance, and Renovation Work*

Lead Type = Key Terms (see pages 8-10)

Key Terms

Certificate of Mailing — written verification from the Postal Service that you mailed the lead pamphlet to an owner or a tenant. This is less expensive than certified mail, which is also acceptable for meeting Lead PRE requirements. (*Note: If using this delivery option, you must mail the pamphlet at least 7 days prior to the start of renovation.*)

Certified Inspector or Risk Assessor — an individual who has been trained and is certified by EPA or an authorized state or Indian Tribe to conduct lead-based paint inspections or risk assessments.

Common Area — a portion of a building that is generally accessible to all residents or users. Common areas include (but are not limited to) hallways, stairways, laundry rooms, recreational rooms, playgrounds, community centers, and fenced areas. The term applies to both interiors and exteriors of the building. (*Note: Lead PRE requirements related to common areas apply only to multi-family housing.*)

Compensation — payment or goods for services rendered. Payment can be in the form of money, goods, or services (bartering).

Component — specific design or structural element or fixture distinguished by its form, function, and location. A component can be located inside or outside the dwelling.

Examples

Interiors

- Ceilings
- Crown molding
- Walls
- Doors and trim
- Floors
- Fireplaces
- Radiators
- Shelves
- Stair treads
- Windows and trim
- Built-in cabinets
- Beams
- Bathroom vanities
- Counter tops
- Air conditioners

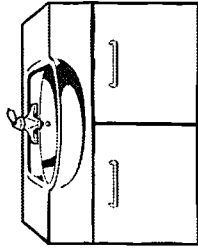

Exterior

- Painted roofing
- Chimneys
- Flashing
- Gutters and downspouts
- Ceilings
- Soffits
- Doors and trim
- Fences
- Floors
- Joists
- Handrails
- Window sills and sashes
- Air conditioners

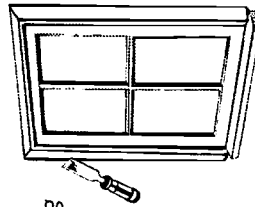

Key Terms (continued)

Emergency Renovation — unplanned renovation activities done in response to a sudden, unexpected event which, if not immediately attended to presents a safety or public health hazard, or threatens property with significant damage.

- Examples 1:** Renovation to repair damage from a tree that fell on a house
2: Renovation to repair a water pipe break in an apartment complex

General Contractor — one who contracts for the construction of an entire building or project, rather than for a portion of the work. The general contractor hires subcontractors (e.g. plumbing, electrical, etc.), coordinates all work, and is responsible for payment to subcontractors.

Housing for the Elderly — retirement communities or similar types of housing specifically reserved for households of one or more persons 62 years of age or older at the time the unit is first occupied.

Lead Abatement — work designed to permanently eliminate lead-based paint hazards. If you are hired to do lead-abatement work only, Lead PRE does not apply. Abatement does not include renovation, remodeling, landscaping, or other activities done to repair, restore, or redesign a given building — even if these activities incidentally reduce lead-based paint hazards. (*Note: Some states define this term differently than described above. Consult your state officials if you are not sure how "lead abatement" is defined in your state.*)

Lead Pamphlet — the pamphlet *Protecting Your Family From Lead in Your Home*, or an EPA-approved alternative pamphlet. (See page 13 for information on obtaining copies.)

Minor Repair and Maintenance — minor repair and maintenance activities, such as minor electrical work or plumbing, that disturb two square feet or less of painted surface per component.

- Examples 1:** Drilling holes in the wall to run an electrical line
2: Replacing a piece of window trim
3: Replacing a light fixture

Multi-family Housing — housing property consisting of more than four dwelling units.

Owner — any person or entity that has legal title to housing, including individuals, partnerships, corporations, government agencies, Indian Tribes, and nonprofit organizations.

Record of Notification — written statement documenting the steps taken to notify occupants of renovation activities in common areas of multi-family housing. (See page 12 for sample.)

Key Terms (continued)

Renovation — modification of all or part of any existing structure in housing that disturbs a painted surface. Includes:

- Removal/modification of painted surfaces, components, or structures
- Surface preparation activities (sanding/scraping/other activities that may create paint dust)
- Window replacement

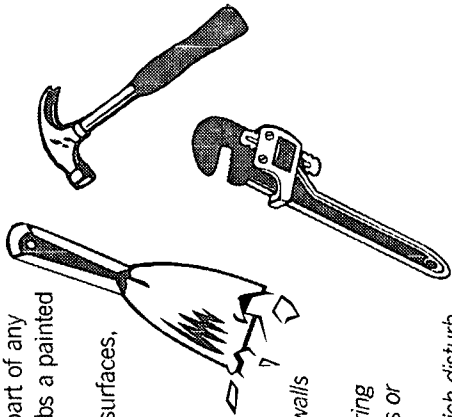

- Examples**
- 1:** Demolition of painted walls or ceilings
 - 2:** Large surface replastering
 - 3:** Major plumbing repairs or improvements
 - 4:** Any other activities which disturb painted surfaces

Renovation Notice — notice to tenants of renovations in common areas of multifamily housing. (See sample form on page 12.) Notice must describe nature, location, and expected timing of renovation activity; and must explain how the lead pamphlet may be obtained free of charge.

Renovator — a person who performs for compensation a renovation, as defined above. (**Note:** Because the term "renovation" is defined broadly by Lead PRE, many contractors who are not generally considered to "renovators," as that term is commonly used, are considered to be "renovators" under Lead PRE, and must follow Lead PRE requirements.)

Self-Certification of Delivery — an alternative method of documenting delivery of the lead pamphlet to a tenant. This method may be used whenever the tenant is unavailable or unwilling to sign a confirmation of receipt of lead pamphlet. (See sample form on page 11.) (**Note:** This method is not a permissible substitute for delivery of the lead pamphlet to an owner.)

Special Trade Contractors — individuals or companies performing work in specialized occupations such as painting, electrical work, plumbing, or carpentry.

Supplemental Renovation Notice — additional notification that is required when the scope, location, or timing of project changes.

Zero-Bedroom Dwelling — any residential dwelling where the living area is not separated from the sleeping area. This term includes efficiency and studio apartments, dormitory housing, and military barracks.

Sample Forms

The forms on the next two pages are sample forms you can use to make documentation of compliance easier.

Confirmation of Receipt of Lead Pamphlet

I have received a copy of the pamphlet, *Protect Your Family From Lead in Your Home*, informing me of the potential risk of the lead hazard exposure from renovation activity to be performed in my dwelling unit. I received this pamphlet before the work began.

Printed name of recipient _____ Date _____

Signature of recipient _____

Self-Certification Option (for tenant-occupied dwellings only) —

If the lead pamphlet was delivered but a tenant signature was not obtainable, you may check the appropriate box below.

- Refusal to sign** — I certify that I have made a good faith effort to deliver the pamphlet, *Protect your Family From Lead In Your Home*, to the rental dwelling unit listed below at the date and time indicated and that the occupant refused to sign the confirmation of receipt. I further certify that I have left a copy of the pamphlet at the unit with the occupant.
- Unavailable for signature** — I certify that I have made a good faith effort to deliver the pamphlet, *Protect Your Family From Lead In Your Home*, to the rental dwelling unit listed below and that the occupant was unavailable to sign the confirmation of receipt. I further certify that I have left a copy of the pamphlet at the unit by sliding it under the door.

Printed name of person certifying lead pamphlet delivery _____ Attempted delivery dates and times _____

Signature of person certifying lead pamphlet delivery _____

Unit Address _____

Note Regarding Mailing Option — As an alternative to delivery in person, you may mail the lead pamphlet to the owner and/or tenant. Pamphlet must be mailed at least 7 days before renovation (Document with a certificate of mailing from the post office).

Sample Forms (continued)

Renovation Notice — For use in notifying tenants of renovations in common areas of multi-family housing.

The following renovation activities will take place in the following locations:

Activity (e.g., sanding, window replacement) _____

Location (e.g., lobby, recreation center) _____

The expected starting date is _____ and the expected ending date is _____. Because this is an older building built before 1978, some of the paint disturbed during the renovation may contain lead. You may obtain a copy of the pamphlet, *Protect Your Family From Lead in Your Home*, by telephoning me at _____. Please leave a message and be sure to include your name, phone number and address. I will either mail you a pamphlet or slide one under your door.

Date _____ Printed name of renovator _____

Signature of renovator _____

Record of Tenant Notification Procedures — Procedures Used For Delivering Notices to Tenants of Renovations in Common Areas

Project Address: _____ (apt. #) _____

Street _____ State _____ Zip Code _____

City _____ Number of dwelling units _____

Owner of multi-family housing _____

Method of delivering notice forms (e.g. delivery to units, delivery to mailboxes of units) _____

Name of person delivering notices _____

Signature of person delivering notices _____ Date of Delivery _____

Where Can I Get Copies of the Lead Pamphlet?

For single copies of *Protect Your Family From Lead in Your Home* (in Spanish or English), call the National Lead Information Clearinghouse (NLIC) at 1-800-424-LEAD. For any orders, be sure to use the stock reference number **EPA747-K-99-001**.

There are four ways to get multiple copies:

1. Call the Government Printing Office order desk at **(202) 512-1800**.
2. Send fax requests to **(202) 512-2233**.
3. Request copies in writing from:
Superintendent of Documents
P.O. Box 371954
Pittsburgh, PA 15250-7954
4. Obtain via the Internet at **www.epa.gov/lead**

Single copies are available at no charge. Bulk copies available in packs of 50.

The pamphlet may be photocopied for distribution as long as the text and graphics are readable. Camera-ready copies are available from NLIC or via the Internet.

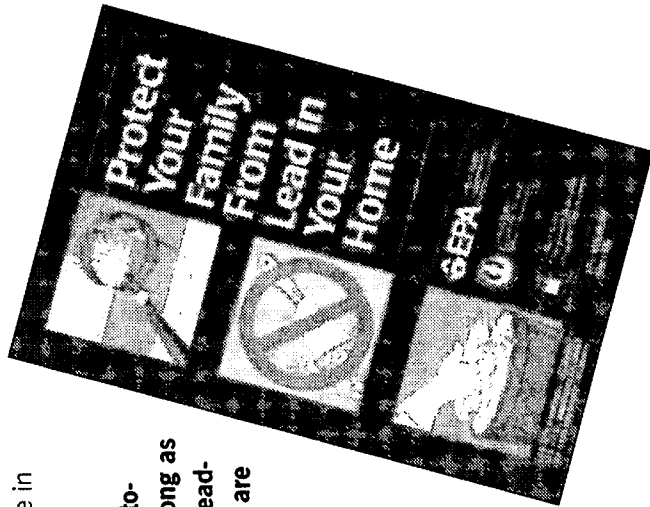

The Lead Pre-Renovation Education Rule (Lead PRE) At-A-Glance

If you will be working for **compensation** in a pre-1978 home or apartment building, answer the questions below to determine if Lead PRE requires you to give the **lead pamphlet** to the **owner** and occupants.

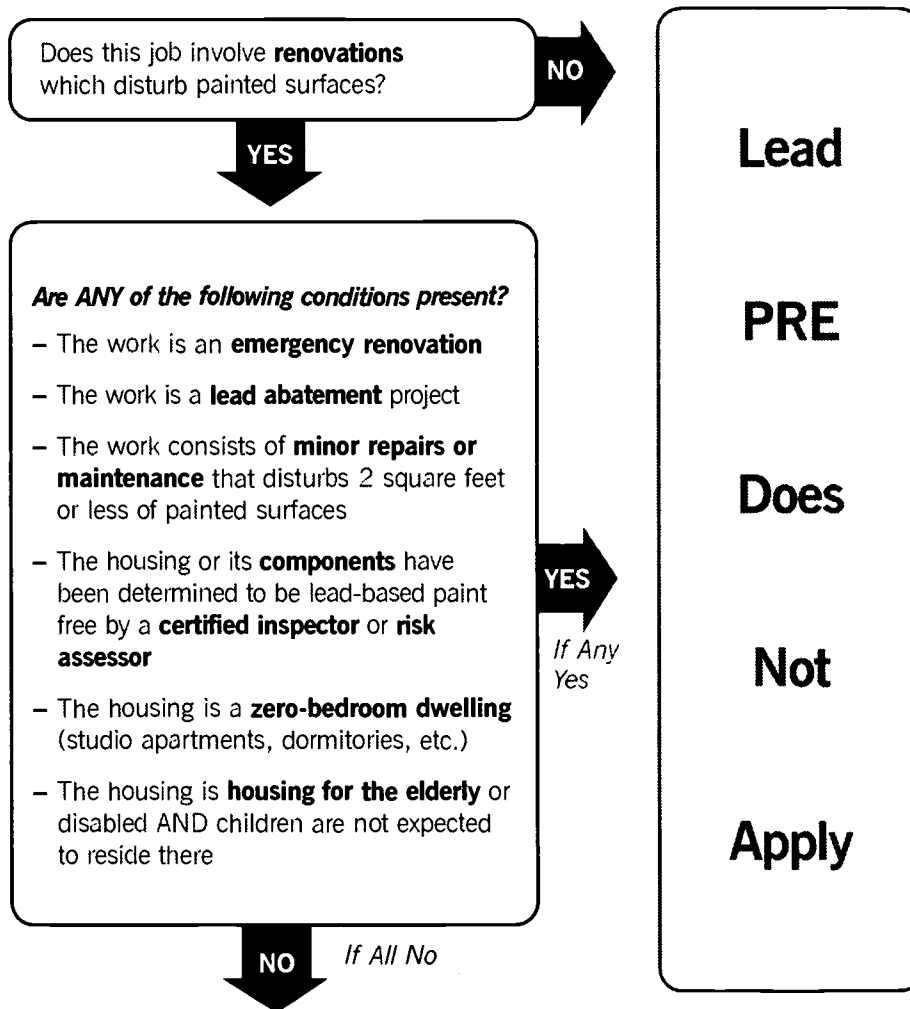

***If no, then you need to read this book!
Rental property owners and managers,
renovators, and maintenance personnel
are affected by Lead PRE.***

Bold Type = Key Terms (see pages 8–10 inside)

**THE LEAD-BASED PAINT PRE-RENOVATION
EDUCATION RULE**

**INTERPRETIVE GUIDANCE FOR CONTRACTORS, PROPERTY MANAGERS, AND
MAINTENANCE PERSONNEL UNDER SECTION 406(b) OF THE LEAD- BASED PAINT
HAZARD REDUCTION ACT OF 1992**

PART I

**May 28, 1999
[Revised June 25, 1999]**

Prepared by the

**Office of Pollution Prevention and Toxics
U.S. Environmental Protection Agency
Washington, D.C. 20460**

1. When a home or an apartment unit is re-painted in preparation for a new tenant, is the painting activity always considered a “renovation” for purposes of the 406(b) rule even if no surface preparation activity is performed prior to painting ?

No. The primary determinant of whether a given activity constitutes a “renovation” under the rule is whether that activity disturbs painted surfaces. The practice of recoating painted surfaces in preparation of new tenants would not constitute “renovation” unless accompanied by surface preparation activities (sanding, scraping, or other activities that may generate paint dust). Minor “spot” scraping or sanding can qualify for the exemption from the rule for “minor repair and maintenance activities” if no more than 2 square feet of paint is disturbed on any component to be painted. (See question 5 below for further explanation of that exemption). Washing down of walls or other components prior to painting does not constitute “surface preparation” for purposes of the rule.

2. If the letter of the regulation is strictly followed, tenants in a large apartment complex will receive several notices regarding repairs to common areas every month, sometimes several in a single week. Is there anyway to avoid such duplication?

EPA believes that in enacting section 406(b) of the Residential Lead-Based Paint Hazard Reduction Act of 1992, Congress intended to provide persons residing in both single family and multi-family housing with information needed to protect against exposure to lead-based paint and lead-based paint hazards during renovations. In multi-family housing, advance knowledge of location and timing of renovation activities in lobbies, hallways, and other common areas is essential for residents wishing to minimize exposures to lead, especially those residents with young children. At the same time, however, neither residents nor owners/managers are well-served if duplicative notifications are issued repeatedly for essentially similar renovation activities. For this reason, EPA wishes to encourage owners/managers to use one or more of the methods described below to provide residents with needed information in the most efficient manner.

(1) **Category Notices** – When renovation activities fall within distinct categories which are performed on a cyclical or recurring basis (e.g., hallway painting), they may be grouped into a single notice which describes the categories and provides a description of the locations affected. To fulfill the requirement for providing timing information for the renovations, owners/managers may either list the expected starting and ending dates, or employ one of the other methods for meeting the timing requirements described below.

(2) **Bi-monthly Notices** – Section 745.85(a) of the rule requires that notifications be

given no more than 60 days before renovation activities begin. To minimize the number of notices required, owners/managers may group all of the renovation activities expected to occur over a 60-day period into a single notice distributed bi-monthly (every other month). Renovation activities which were expected to occur within a given 60-day period, but which were canceled or postponed, would simply be addressed in the subsequent bi-monthly notice. Including renovation notices in, or as an attachment to, a pre-existing newsletter is acceptable provided that the cover of the newsletter prominently indicates that lead-based paint renovation notices are contained in or attached to the newsletter.

(3) Descriptions of Renovation Timing -- Section 745.85(b)(2) of the rule requires that notices contain the “expected starting and ending dates” of the proposed common area renovations. Although providing specific dates is preferable wherever possible, the Agency is aware that unexpected events or circumstances often result in delays and/or cancellations of planned renovation activities. To provide sufficient flexibility without unduly compromising residents’ rights to information on timing of renovations in common areas, owners/managers may employ the following terminology to address the following timing scenarios to avoid the needing to issue supplemental notices:

–“On or about” -- acceptable when the expected starting or ending dates occurs one week before or after the date given.

–“Early [insert month name]” -- acceptable when the expected starting or ending dates occurs during the first half of the specified month.

–“Late [insert month name]” -- acceptable when the expected starting or ending dates occurs during the second half of the specified month.

–“Ongoing for the 12-month period beginning [insert month name]” -- acceptable when the renovation commences within 60 days of the issuance of the notice and continues throughout the 12-month period. If an interruption of more than 60 days occurs anytime after commencement of such activity, a new notice will be required before the activity may restart.

(4) Descriptions of Renovation Ending Dates -- Due to the inherent difficulties in estimating the duration of many renovation activities, owners/managers are encouraged to make allowances for unexpected delays when providing descriptions of ending days under Section 745.85(b)(2) of the rule. Any estimated ending date with a rational basis is acceptable.

3. Pamphlet distribution requirements may interfere with prompt responses to maintenance/repair requests. Specifically, the requirement for obtaining a tenant's signature on an acknowledgment of receipt prior to commencement of the work may delay the repairs for a day or more.

EPA believes that potential delays in making requested repairs can be readily avoided either through minor revisions of existing administrative procedures or by employing the "self-certification" delivery procedures enumerated in section 745.85(a)(2) of the rule. *[Regarding the former, an owner/manager may attach or incorporate the required acknowledgment statement into any existing repair request forms, and may distribute a copy of the pamphlet along with the form to all tenants on a one-time basis. Whenever a repair is needed, the tenant would simply fill out a repair request form and acknowledge receipt of the lead information pamphlet at the same time.]* Alternatively, the self-certification provisions provide that a person delivering a pamphlet to a unit where an adult occupant is unavailable for signing an acknowledgment may sign and date a statement attesting to that unavailability and to the delivery of the pamphlet to the unit. Owners/managers are reminded that they may also employ the "emergency renovation operations" exemption under section 745.82 where the needed repairs pose a safety or health hazard, or threaten significant equipment or property damage. See section 745.83 for the specific definition of this term.

[NOTE: The bracketed language in italics above contains incorrect information regarding timing of pamphlet delivery. Consult the June 25, 1999 Correction and Clarification for amended guidance.]

4. Must notifications for common area renovations be provided to every unit in a multifamily housing complex in all cases?

Section 745.85(b)(2) states that notification of renovations in common areas of multi-family housing "shall be accomplished by distributing written notice to each affected unit." (Emphasis added). In most cases where such renovations are performed, all units in the housing are "affected units" because a common area is, by definition, "a portion of a building that is generally accessible to all occupants." Section 745.103. In some limited instances in large apartment buildings, however, EPA recognizes that certain areas of the building, while meeting the literal definition of a common area, are, in practice, used almost exclusively by an identifiable subset of tenants, e.g., a hallway on an upper floor of a multi-story building. EPA believes that providing notices to every unit in a large building when renovations are occurring in only one such "limited use common area" is unduly burdensome and does not result in appreciable reductions in lead exposures. Therefore, for purposes of this rule, EPA will interpret the common area notification requirements of the rule as follows: First, where renovation activity takes place in an area within a common area which is used almost exclusively by an identifiable subset of residents of a large apartment building, the Agency will interpret the term "affected units" to refer only to those units

serviced by, or in close proximity to, the limited use common area. Second, the term “large apartment building” shall mean multifamily housing with 50 or more dwelling units. EPA believes that need for special treatment for limited use common areas is less compelling when dealing with apartment buildings with fewer than 50 units because (1) the burden of providing notifications to every unit in the building is not unreasonable, and (2) in general, there are fewer areas within smaller apartment buildings which would meet the criteria for a limited use common area designation. Third, to ensure notification of tenants who may enter a limited use common area but are not among the subset of tenants identified for individual notification, the renovator must post placards at all accessible entrances to the renovation work site which prominently conveys the same information required under section 745.85(b)(2).

5. Please provide guidance on how the Agency will interpret the exemption for “minor repair and maintenance activities,” e.g., what constitutes a “component”? May the 2 square feet value be aggregated among several components? Does the exemption apply to window replacement activities?

The exemption applies to “minor repair and maintenance activities (including minor electrical work and plumbing) that disrupt 2 square feet or less of painted surface per component.” 40 C.F.R. section 745.82(b)(1). The term “component[s]” is defined, in relevant part, in the section 402 rule as

“ . . . specific design or structural elements or fixtures of a . . . dwelling . . . that are distinguished from each other by form, function, and location. These include, but are not limited to, interior components such as: ceilings, crown molding, walls, chair rails, doors, door trim, floors, fireplaces, radiators and other heating units, shelves, shelf supports, stair treads, stair risers, stair balustrades, windows and trim (including sashes, window heads, jambs, sills or stools and troughs), built-in cabinets, columns, beams, bathroom vanities, counter tops, and air conditioners; and exterior components such as: painted roofing, chimneys, flashing, gutters and downspouts, ceilings, soffits, fascias, rake boards, cornerboards, bulkheads, doors and door trim, fences, floors, joists, lattice work, railings and railing caps, siding, handrails, stair risers and treads, stair stringers, columns, balustrades, window sills or wells, and air conditioners.” 40 C.F.R. 745.223

The Agency wishes to emphasize several aspects of this exemption which have been overlooked by some readers of the final rule. First, the central tenet of the exemption was that it was designed to apply only to activities which can reasonably be characterized as “minor repair and maintenance.” Any over-emphasis on the mechanics of the exemption serves to inappropriately divert attention from the central purpose of the exemption: to provide regulatory relief for those activities which are truly minor in scope. Common examples of the types of activities the Agency

wanted to exempt in the final rule were repairs to electrical outlets and switches, replacement/repair of plumbing fixtures, and spot repairs of painted walls, ceilings, trim, and molding. Second, the exemption was not intended to provide an avenue to circumvent the requirements of the rule; some have questioned the permissibility of dividing up a renovation project into separate sub-projects, each of which disturbs 2 square feet or less of painted surfaces, or of multiplying the number of components in a room by 2 square feet to come up with an overall *de minimis* value . If any aspect of a renovation project results in disturbance of more than 2 square feet on any component in the area renovated, the entire project is subject to the rule. Finally, EPA wishes to clearly state that window replacements do not qualify for this exemption to the rule because (a) the definition of the term “renovation” specifically includes window replacement; and (b) replacement of a window(s) cannot reasonably be classified as “minor repair and maintenance activities.”

**THE LEAD-BASED PAINT PRE-RENOVATION
EDUCATION RULE**

**INTERPRETIVE GUIDANCE FOR CONTRACTORS,
PROPERTY MANAGERS, AND MAINTENANCE
PERSONNEL UNDER SECTION 406(b) OF THE LEAD-
BASED PAINT HAZARD REDUCTION ACT OF 1992**

**Correction and Clarification to Part I Interpretive Guidance
Regarding Timing of Pamphlet Delivery**

June 25, 1999

Prepared by the

Office of Pollution Prevention and Toxics
U.S. Environmental Protection Agency
Washington, D.C. 20460

Correction and Clarification Regarding Timing of Pamphlet Delivery

EPA wishes to issue the following correction and clarification regarding timing of the lead hazard pamphlet distribution, addressed in the May 28, 1999 Interpretive Guidance:

In response to question number 3. of the Interpretive Guidance, it was stated that an

“owner/manager may attach or incorporate the required [lead pamphlet] acknowledgment statement into any existing repair request forms, and may distribute a copy of the pamphlet along with the form to all tenants on a one-time basis. Whenever a repair is needed, the tenant would simply fill out a repair request form and acknowledge receipt of the lead information pamphlet at the same time.”

The portion of the above statement related to distribution of the lead hazard pamphlet is incorrect: although copies of the acknowledgment form may be provided to all tenants on a one-time basis, section 745.85(a) of the regulations clearly states that the lead hazard pamphlet must be distributed no more than 60 days before the subject renovation begins. Therefore, although an owner/manager may choose to distribute copies of the acknowledgment form and pamphlet to all tenants on a one-time basis to introduce tenants to the new pre-renovation rule requirements, an additional pamphlet delivery would be needed if any renovation is to begin more than 60 days after such a mass distribution.

In comments on the proposed section 745.85(a), several persons and organizations pointed out that the requirement to deliver the pamphlet no more than 60 days in advance of any renovation activity covered by the rule would result in some tenants receiving multiple copies of the pamphlet. In developing the final pre-renovation education rule, EPA carefully weighed whether a one-time pamphlet distribution would be adequate to meet the objectives of section 406(b) of the lead statute, and concluded that many, if not most, tenants would benefit from receiving the information in the lead pamphlet closer to the time that a renovation is to begin. Although some tenants may read lead information delivered on a “for-your-information” basis, many others are not likely to focus on potential lead hazards until a renovation affecting their unit is imminent, and would welcome receiving information on protecting their families from lead in a more timely fashion. To alleviate potential delays in performing repairs when tenant acknowledgments are not obtainable, section 745.85(a)(2)(i) of the final rule permits owners/managers to “self-certify” that a pamphlet has been delivered to the unit before the renovation begins.

**THE LEAD-BASED PAINT PRE-RENOVATION
EDUCATION RULE**

**INTERPRETIVE GUIDANCE FOR CONTRACTORS, PROPERTY MANAGERS, AND
MAINTENANCE PERSONNEL UNDER SECTION 406(b) OF THE LEAD- BASED PAINT
HAZARD REDUCTION ACT OF 1992**

PART II

October 15, 1999

Prepared by the

**Office of Pollution Prevention and Toxics
U.S. Environmental Protection Agency
Washington, D.C. 20460**

[See Part I for questions 1. - 5.]

6. Who is responsible for providing required notifications when multiple contractors are involved in a given renovation?

If the renovation activity on a given job is overseen by a general contractor, the general contractor is considered to be the “renovator” under the rule, and thus is responsible for ensuring that the requirements of the rule are met. A subcontractor would not be considered a “renovator” so long as he/she has no direct contractual relationship with the property owner or manager relating to the given job. If a general contractor is not involved, any contractor who performs work on a job which constitutes “renovation” under the rule is responsible for complying with the information distribution and recordkeeping requirements of the rule. However, after those requirements have been met by one contractor on a given job, subsequent contractors working on the same job need not provide additional distributions/notifications. To verify that an earlier contractor has complied with the rule, subsequent contractors are advised to personally review and, if possible, obtain copies of pamphlet delivery confirmations and related records. If such records or copies thereof are not present at the job site or otherwise not readily available, however, subsequent contractors may rely upon representations by the earlier contractor, a property manager, or a property owner that the rule requirements have been met, provided that such representations are documented in writing and signed by the party making the representations. Subsequent contractors who rely upon verbal representations of a prior contractor’s compliance with the rule may be held liable for non-compliance if those representations are incorrect.

7. If an outside contractor is hired to perform a renovation in an apartment building, can the contractor effect delivery of the lead hazard pamphlet to the owner of the building via the property manager?

The statutory language of section 406(b) specifically requires that the pamphlet be provided to both owners and occupants of target housing. This provision underscores the importance of notifying building owners of the potential hazards of lead-based paint during renovations. Awareness of these potential hazards helps not only to ensure protection of tenants, but also to alert building owners of potential liabilities if appropriate work practices are not followed. In many apartment buildings, however, it is the property managers who are the day-to-day operators of the facilities, and as such, they are acting in the capacity of agents for the building owners. For this reason, EPA believes it is appropriate to permit a property manager to receive, and acknowledge receipt of, the lead hazard pamphlet on behalf of the owner.

In situations where property managers or their employees are performing the renovations themselves, they are acting both as “renovators” and as agents for the owner under the rule, and thus no separate action is required to satisfy the requirement to deliver the lead hazard pamphlet to the owner because documents in the possession of an agent are deemed to be also on the

possession of the person or entity represented by the agent.

8. Is a renovation performed by a landlord or by employees of a management firm considered a “compensated” renovation under the rule?

Yes. By paying rent, tenants are, in virtually all instances, contracting for both the right to occupy a unit, and for repair/maintenance services to the unit. Therefore, even though money does not typically change hands at the time repair or maintenance services are rendered, such services, if they meet the definition of “renovation” under the rule, are considered to be compensated renovations for purposes of section 406(b).

9. Is the installation of new exterior siding over an existing painted surface considered a “renovation” under the rule?

Installation of new exterior siding requiring any removal or modification of existing painted surfaces or painted components to ensure a uniform and structurally secure underlayment for the new siding is considered “renovation” under the section 406(b) rule. In some cases, however, installation activities consist solely of attaching the new siding to the existing painted surface or structural members under the existing painted surface with nails, screws, or other fastening devices or materials. In these cases, the Agency believes that the disturbance to the existing painted surfaces is minimal, and therefore does not consider these latter types of re-siding activities to be “renovation” for purposes of the section 406(b) rule.

10. Does the “limited uses common area” rule discussed in the Part I Interpretive Guidance (question no. 4) apply to multi-building apartment complexes?

Yes. The Agency determined that it was reasonable to permit alternative notification procedures in large apartment buildings where the renovations were occurring in an area within a common area which is used almost exclusively by an identifiable subset of residents. The Agency stated that in such “limited use common areas”, the section 406(b) notification requirements would be satisfied if (1) individual renovation notices were distributed to those units serviced by, or in close proximity to, the limited use common area, and (2) placards were posted at all accessible entrances to the renovation work site which prominently conveyed the information required under section 745.85(b)(2) of the regulations. The Agency believes that the same logic should be applied to multi-building apartment complexes; therefore, whenever a renovation occurs in a limited use common area, multi-building apartment complex comprised of 50 or more dwelling units on a contiguous site, the notification procedures described above are adequate under the

rule.

11. Is the exterior of a building included within the meaning of a “common area”? If an apartment complex consists of several separate buildings, does a common area renovation in one building trigger the requirement to notify tenants in all buildings?

The examples cited in the definition of the term “common area” under section 745.103 clearly indicate that both interiors and exteriors of buildings are included within the meaning of the term. If a renovation is being performed in a common area on the interior of one building in a multi-building complex, then only the units located in that building need to receive renovation notices. If the renovation is being performed on the exterior of one of the buildings or elsewhere on the complex grounds, however, written notice of the renovation must be provided to every unit in the complex unless the renovation is occurring in an area which qualifies as a “limited use common area” as described in questions 4 and 9 above.

12. If renovation activity is being performed on a balcony of a unit, does that activity trigger the common area notification requirements?

Under section 745.103 of the rule, a “common area” is defined as “a portion of a building that is generally accessible to all occupants.” A balcony which is generally accessible only by the occupants of an individual dwelling unit does not fall within this definition. Therefore, renovation activities taking place within the confines of a balcony would be subject only to the requirements applicable to renovations within an individual unit. Note, however, that if such renovations are not confined to the balcony, i.e., result in the release of dust, paint chips, or other construction debris to the outside of the building, the persons performing the renovation would be required to follow the rule requirements applicable to renovations in common areas.

13. Can common area renovation notices be delivered to the mailboxes of a unit, or only to the unit itself?

The requirement to distribute common area renovation notices to dwelling units in multi-family housing may be satisfied either through delivery of the notices directly to tenant units or through delivery to tenant mailboxes. If mailbox delivery is used, both hand delivery and delivery via U.S. mail is acceptable; however, U.S. mail deliveries must be sent 7 days prior to the commencement of renovations and documented with a certificate of mailing.

14. If you “seal off” a common area for the duration of a renovation, does the renovator

still have to provide notifications to all tenants?

When tenant accessibility to a work site within a common area can be precluded for the duration of a renovation, the Agency considers that work site to be temporarily excluded from the common area of the building because it is not accessible to the residents and users of the building. To qualify for this exclusion, however, the work site must be in an area which is enclosed by a wall, fence, or other permanent or temporary physical barrier which prevents access by tenants and other building users. Rope, tape lines, pylons, and similar work area designation devices which can be easily surmounted or bypassed are not acceptable barriers.

15. Does the “emergency repair” exemption apply to the entire repair, or only that portion of the repair which addresses the source of the emergency.

The exemption for emergency renovations was added to the final rule to address situations in which non-routine failures of equipment necessitate immediate action to address safety or public health hazards or threats of significant damage to equipment and/or property. In these types of situations, the need for immediate action clearly outweighs the need to provide lead hazard information to tenants before the renovation is commenced. Once the portion of the repair that addresses the source of the emergency is completed, however, the justification for the exemption from the rule is no longer operative; therefore, any additional renovation activity needed to return the renovation work area to its pre-emergency condition would be subject to the requirements of the rule. Thus, for example, repairing a hole in a wall after a broken water pipe has been repaired would be subject to the rule, as would repainting any water-stained walls or ceilings resulting from the pipe break.

16. Does a renovator need to attempt personal delivery of the lead information pamphlet to a tenant more than one time before utilizing the “self-certification of pamphlet delivery” option?

Personal delivery of the lead information pamphlet is preferable, wherever possible, because EPA believes that tenants will be more likely to read the information if it is handed directly to them. It also affords tenants an opportunity to raise concerns and ask questions about the renovation. In drafting the final rule, however, the Agency recognized that personal delivery would not always be a viable option, especially when a renovation needs to be commenced on short notice and an adult occupant of the apartment is not available. For this reason, the Agency included a provision in the final rule which permits the person delivering the pamphlet to “self-certify” the delivery (40 C.F.R. 745.85(a)(2)(i)). Although it is recommended that delivery be attempted on more than one occasion, a single good faith delivery attempt is acceptable for purposes of the rule. SPECIAL NOTE: the self certification provisions of the rule apply only to pamphlet deliveries to rental units; renovators cannot self-certify a pamphlet delivery to the owner of the dwelling unit. Pamphlet deliveries to unit owners must be made directly to the owner, an agent of the owner, or

17. In a typical co-operative apartment building, occupants do not own the individual units; rather they “own” an undifferentiated share in the entire building and then “rent” back a specific unit from the co-operative corporation. Similarly, in a typical condominium building, owners of individual units jointly own the common areas of the building. For purposes of the rule, who are the “owners” in such situations?

EPA recognizes that co-operative apartments (“co-ops”) and condominiums (“condos”) can be structured in a variety of ways. For example, in the case of co-ops, a corporation (sometimes referred to as a “co-op association”) is often established and owns all the units and common areas comprising the co-op; in such circumstances, individual unit “shareholders” own shares in the corporation and also own occupancy rights or lease a unit from the corporation. In the case of many condos, individuals hold title to their individual units, and all condo unit owners jointly own the common areas (with a condo association established to represent the interests of all the unit owners).

For purposes of this rule, the following general principles will be applied:

(a) if title to a building is held by a corporation which leases back dwelling units to individual corporation shareholders, as in typical co-op apartment buildings, the corporation/association will generally be considered to be the “owner” of the entire building, and individual resident shareholders, or persons who rent from individual shareholders, will generally be considered to be tenants.

(b) In buildings where individuals hold title to specific dwelling units and jointly hold title to common areas of the building, as in typical condo buildings, the individual owners each will be considered to be the owners of his/her individual units, and the association (or its equivalent body composed of, or representing, the group of owners) will be considered the owner of the common areas of the building.

See the attached Table A for more specific guidance on meeting the requirements of the rule as they relate to various renovation scenarios in co-ops and condos.

TABLE A
COMPLIANCE WITH §406(b) PRE-RENOVATION RULE FOR
COOPERATIVE APARTMENTS AND CONDOMINIUMS

RENOVATION LOCATION	RULE REQUIREMENT	COMPLIANCE FOR CO-OPs	COMPLIANCE FOR CONDOS
Renovations Inside Individual Unit	<ol style="list-style-type: none"> 1. Deliver Pamphlet to Owner §745.85(a)(1) 2. Deliver Pamphlet to Adult Occupant (Tenant) §745.85(a)(2) 	<ol style="list-style-type: none"> 1. Deliver Pamphlet to Co-op Corp./Assoc. or Property Manager 2. Deliver Pamphlet to Resident Co-op Share holder or Adult Occupant 	<ol style="list-style-type: none"> 1. Deliver Pamphlet to Condo Unit Owner (Or Agent of Owner) 2. If Condo is Leased, Deliver Pamphlet to Adult Occupant
Renovations In a Common Area	<ol style="list-style-type: none"> 1. Deliver Pamphlet to Owner §745.85(b)(1) 2. Deliver Notice to Each Unit §745.85(b)(2) 	<ol style="list-style-type: none"> 1. Deliver Pamphlet to Co-op Corp./Assoc. or Property Manager 2. Deliver Notice to Each Unit 	<ol style="list-style-type: none"> 1. Deliver Pamphlet to Condo Association or Property Manager 2. Deliver Notice to Each Unit

APPENDIX 5

Liability Insurance Summary Fact Sheet

FACT SHEET

Liability Insurance Summary

There are three types of liability insurance that individuals and firms involved in residential renovation, remodeling and painting should consider when evaluating their insurance needs:

- Commercial General Liability (CGL);
- Professional liability errors and omissions (E&O); and
- Pollution liability.

In addition, there are two coverage “triggers” in liability insurance policies:

- Occurrence-based; and
- Claims-made.

This document discusses the types of insurance and policy coverage triggers, and then provides a list of questions to consider when deciding what type of insurance to purchase.

Types of Insurance

Commercial General Liability Insurance. CGL policies are typically carried by contractors and contracting firms. They cover claims arising from business premises liability exposures, on-site contracting operations liability, liability assumed in a construction contract, liability arising out of the work performed by hired independent contractors, liability arising out of products that are manufactured, sold or installed, and liability arising out completed work or projects.

Professional Liability Errors and Omissions Insurance. E&O policies are usually carried by those persons and firms that render “professional services,” such as architects, engineers, designers, management planners, risk assessors, lead paint inspectors and others that design and write specifications for renovation, remodeling and painting projects. These policies cover liability that results from providing or failing to provide such professional services.

Under the law, “professionals” are held to a higher standard of care than laymen, and most CGL policies have exclusions for claims that result from the performance, or failure, of the professional service. E&O policies cover only the professional act itself; therefore, they cover a far narrower range of potential claims than CGL policies. CGL coverage protects contractors from liability due to accidents while E&O coverage protects professionals from liability that results from giving advice or providing other professional services. For example, a lead inspector who drops a flashlight onto and injures a passing tenant will be covered by CGL insurance if a claim is brought. If the lead inspector fails to identify lead-containing materials and there is a resulting claim,

he or she will be covered by E&O insurance. An architect who designs a defective containment scaffold that collapses would be covered by E&O. If a worker incorrectly assembles a properly designed scaffold, any resulting accidents would be covered by CGL.

Pollution Liability Insurance. Standard CGL and E&O insurance almost always contains a "pollution exclusion" or other clause that excludes coverage for liability caused by "pollution." To the extent that residential renovation, remodeling and painting projects generate lead-related "pollutants" or "contaminants," CGL and E&O policies may not cover any resulting claims. Therefore, it may also be necessary to consider acquiring special pollution liability insurance and/or a CGL or E&O policy that has been specifically written or endorsed to include coverage of claims and suits for bodily injury and property damage contamination caused by lead.

Occurrence-based Versus Claims-made Insurance

Liability insurance policies are written as either "occurrence-based" or "claims-made." An **occurrence-based** policy is one that covers claims that result from an accident that occurs during the term of the insurance policy, regardless of how long it takes for the claim to be made. It does not matter if the policy expired years before the claim finally arises; as long as the accident or exposure to injurious conditions or substances happened or "occurred" during the policy term, the resulting claim will be covered by the insurance. Some occurrence-based policies may include **sunset clauses**. A sunset clause states that the coverage lasts for a limited time beyond the expiration date of the policy. For example, if a policy has a sunset clause after five years, and expires on December 31, 2001, then any claims made after December 21, 2006 will not be covered. These clauses are not very prevalent although they sometimes appear in pollution liability policies.

A **claims-made** policy covers a claim for an accident, as long as both the accident and the claim take place while the policy is in force. The policyholder must have a claims-made policy in effect when the claim is first made against the policyholder and reported to the insurance company in order to have coverage. If the policy has expired or been canceled after the accident but before the claim comes in, the policyholder has no insurance coverage. Most claims-made policies include a **retroactive or retro-date clause**. The retroactive clause states that the policy will not cover any claims resulting from accidents that happened more than a specified amount of time before the inception date of the policy.

Insurance companies may be willing to modify insurance policy provisions during negotiations and before policy inception. Some insurers offering occurrence-based insurance will drop or extend the periods of sunset clauses prior to writing the policy. Some insurers offering claims-made insurance can be persuaded to push the retro-date back to an earlier time, so that the policyholder will be covered for all claims arising

from the insured's previous activities. Also, most insurers now provide or offer **extended discovery periods** endorsements for claims-made policies. For an additional premium, the policyholder gains an extension of time during which to file claims after the policy expires, as long as the accident occurred during a time period covered by the expiring policy. Extended discovery periods of one year are common. Longer periods are less common.

Generally, most CGL policies are occurrence-based while most E&O policies are claims-made.

Financial Viability of Insurers

Regulation of insurance is left to the states and, depending on the structure of insurance companies and the types of insurance coverage being offered, that regulation and financial oversight might be extensive, limited or non-existent. Pre-approval of policy forms and rates, and periodic financial and operational audits may or may not be required. However, most all insurance companies have some minimum capitalization requirements before they can write any business. Yearly financial statements should be available that provide details on the company's financial viability.

Additionally, there are independent commercial rating services that report on the insurance company's relative financial strength, balance sheet, profit and loss statement, investments, financial reserves to pay for claims, claims payment history, management expertise and lines of business written. These services include A. M. Best Company and Moody's. The reports published by A. M. Best and Moody's provide another source of information on insurers' financial viability and stability.

Insurance Availability

CGL and E&O policies are widely available in the commercial insurance market, but lead-specific and other pollution liability policies are not. Further, those pollution liability policies currently available have high minimum premiums and vary in terms of the coverage provided. This coverage is often very narrowly written and may have a number of conditions and exclusions that will limit applicability to certain claim and/or suit situations.

Questions to Ask When Choosing Insurance

To determine what types of insurance are appropriate for residential renovation, remodeling and painting projects and whether a particular insurer is financially viable and stable, individuals and firms engaged in this work should consult with their insurance agent or broker, professional risk manager and/or attorney. Questions that should be asked and answered include the following:

1. Is CGL insurance adequate for the types of claims exposures my work will create?
2. Does my work specifically include providing professional services for which E&O insurance is intended?
3. Does my existing insurance cover "bodily injury" or "property damage" caused by exposure to lead?
4. Will I be working in properties that might contain lead-based paint and result in my work generating lead contamination and exposure?
5. Is my exposure to lead-specific or pollution-related claims so small as to eliminate the need for special pollution liability insurance? How often will painted surfaces and components in properties where I work be tested for lead-based paint?
6. If I choose not to purchase CGL, E&O or special pollution liability insurance policies that cover lead liability claims, will it limit my ability to bid on projects or to be deemed acceptable for some residential renovation, remodeling or painting projects? If so, is that acceptable to me?
7. If I choose not to purchase CGL, E&O and/or special pollution liability insurance policies that cover lead liability, can I afford to bear the out-of-pocket cost and responsibility of handling, investigating, defending and paying for any claims or suits against me?
8. For those insurance policies that I am considering, what are the financial ratings of the insurers under consideration, as determined by independent insurance company rating services such as the A. M. Best Company and Moody's? Have any state insurance departments placed such insurers on a financial "watch" list or under supervision?
9. For those insurance policies that I am considering, are there any policy conditions or exclusions that would limit coverage of a claim or law suit?

APPENDIX 6

OSHA Respiratory Protection Standard Overview

**OCCUPATIONAL SAFETY AND HEALTH ADMINISTRATION
LEAD EXPOSURE IN CONSTRUCTION (#5 IN A SERIES OF 6)
RESPIRATORY PROTECTION**

Although engineering and work practice controls are the primary means of protecting workers, source control at construction sites is often not sufficient to control exposure, and airborne lead concentrations may be high or may vary widely.

Presently, in the construction industry, respirators must often be used to supplement engineering controls and work practices whenever these controls are technologically incapable of reducing worker exposures to lead to or below 50 $\mu\text{g}/\text{m}^3$.

To provide adequate respiratory protection, respirators must be donned before entering the work area and should not be removed until the worker has left the area, or as part of a decontamination procedure. Employers must assure that the respirator issued to the employee is properly selected and properly fitted so that it exhibits minimum facepiece leakage. Respirators must be supplied by the employer at no cost to employees. Employers must perform either qualitative or quantitative fit tests for each employee wearing negative pressure respirators. Fit testing is to be performed at the time of the initial fitting and at least semiannually thereafter.

RESPIRATOR PROGRAM: When respirators are provided, the employer must establish a respiratory protection program in accordance with the OSHA standard on respirator protection, 29 CFR 1910.134.

Minimum requirements for an acceptable respirator program for lead include the following elements:

- * Written standard operating procedures governing the selection and use of respirators;
- * Selection of respirators on the basis of hazards to which the worker is exposed;
- * Instruction and training in the proper use of respirators and their limitations;
- * Regular inspection and cleaning, maintenance and disinfection; worn or deteriorated parts must be replaced, including replacement of the filter element in an air-purifying respirator whenever an increase in breathing resistance is detected.
- * Storage in a convenient, clean, and sanitary location and protection against sunlight and physical damage;
- * Appropriate surveillance of work area conditions and degree of worker exposure or stress (physiological or psychological) must be maintained;
- * Evaluation to determine the continued effectiveness of the program;
- * Physician's determination that the employee is physically able to perform the work and wear a respirator while performing the work (respirator user's medical capacity to wear and work with a respirator should be reviewed annually);
- * Use of Mine Safety and Health Administration/National Institute for Occupational Safety and Health (MSHA/NIOSH) certified respirators;
- * Fit testing of negative-pressure respirators;
- * Breathing air used for supplied-air respirators must meet the requirements prescribed in 1910.134(d)(1); and

* Standing permission for employees to leave the work area to wash their faces and respirator face pieces whenever necessary to prevent skin irritation associated with respirator use.

RESPIRATOR SELECTION: Lead concentrations may vary substantially throughout a workshift as well as from day-to-day. The highest anticipated work concentration is to be used in the initial selection of an appropriate respirator.

Fact Sheet 92-50, "Exposure Ranges for Construction Activities," provides potential airborne exposure ranges associated with various activities commonly found in construction. These values may not be correct in every instance but can be used as guidance in making preliminary selection of respiratory types. The table, "NIOSH-recommended Respiratory Protection for Workers Exposed to Inorganic Lead," which appears here provides specific recommendations for the type of respirator to use when the actual workplace exposure reaches certain multiples of a 50 ug/m³ permissible exposure limit (PEL). When an employer finds that exposures are lower or higher by personal air monitoring, then respirator selection can be adjusted accordingly.

In addition, if exposure monitoring or experience indicates airborne exposures to contaminants other than lead, such as solvents or polyurethane coatings, these exposures must be considered when selecting respiratory protection. A reevaluation of the respiratory protection program is required when a worker demonstrates a continued increase in blood lead levels.

ABRASIVE BLASTING AND RELATED OPERATIONS: NIOSH type CE respirators are required for use by abrasive blasting operators. Currently, NIOSH certifies both continuous flow and positive pressure respirators for abrasive blasting operations. The continuous-flow respirators are recommended by NIOSH only for airborne concentrations less than or equal to 25 times the OSHA PEL of 50 ug/m³. Positive pressure respirators are recommended by NIOSH for airborne concentrations less than 2,000 times the OSHA PEL (50 ug/m³). Furthermore, manufacturer's instructions regarding quality of air, air pressure, and inside diameter and length of hoses must be strictly followed. Use of longer hoses or smaller inside diameter hoses than the manufacture's specifications, or hoses with bends or kinks may restrict the flow of air to a respirator.

This is one of a series of fact sheets highlighting U.S. Department of Labor programs. It is intended as a general description only and does not carry the force of legal opinion. This information will be made available to sensory impaired individuals upon request. Voice phone: (202) 693-8151. TDD message referral phone: 1-800-326-2577.

APPENDIX 7

OSHA Lead in Construction Standard Summary

OSHA Standard 29 CFR 1926.62
Lead Exposure In Construction; Interim Final Rule

Employee Standard Summary - 29 CFR 1926.62 Appendix B

This appendix summarizes key provisions of the interim final standard for lead in construction that you as a worker should become familiar with.

I. Permissible Exposure Limit (PEL) - Paragraph (C)

The standard sets a permissible exposure limit (PEL) of 50 micrograms of lead per cubic meter of air (50 ug/m^3), averaged over an 8-hour workday which is referred to as a time-weighted average (TWA). This is the highest level of lead in air to which you may be permissibly exposed over an 8-hour workday. However, since this is an 8-hour average, short exposures above the PEL are permitted so long as for each 8-hour work day your average exposure does not exceed this level. This interim final standard, however, takes into account the fact that your daily exposure to lead can extend beyond a typical 8-hour workday as the result of overtime or other alterations in your work schedule. To deal with this situation, the standard contains a formula which reduces your permissible exposure when you are exposed more than 8 hours. For example, if you are exposed to lead for 10 hours a day, the maximum permitted average exposure would be 40 ug/m^3 .

II. Exposure Assessment - Paragraph (D)

If lead is present in your workplace in any quantity, your employer is required to make an initial determination of whether any employee's exposure to lead exceeds the action level (30 ug/m^3 averaged over an 8-hour day). Employee exposure is that exposure which would occur if the employee were not using a respirator. This initial determination requires your employer to monitor workers' exposures unless he or she has objective data which can demonstrate conclusively that no employee will be exposed to lead in excess of the action level. Where objective data is used in lieu of actual monitoring the employer must establish and maintain an accurate record, documenting its relevancy in assessing exposure levels for current job conditions. If such objective data is available, the employer need proceed no further on employee exposure assessment until such time that conditions have changed and the determination is no longer valid.

Objective data may be compiled from various sources, e.g., insurance companies and trade associations and information from suppliers or exposure data collected from similar operations. Objective data may also comprise previously - collected sampling data including area monitoring. If it cannot be determined through using objective data that worker exposure is less than the action level, your employer must conduct monitoring or must rely on relevant previous personal sampling, if available. Where monitoring is required for the initial determination, it may be limited to a representative number of employees who are reasonably expected to have the highest exposure levels. If your employer has conducted appropriate air sampling for lead in the past 12 months, he or she may use these results, provided they are applicable to the same employee tasks and exposure conditions and meet the requirements for accuracy as specified in the standard. As with objective data, if such results are relied upon for the initial determination, your employer must establish and maintain a record as to the relevancy of such data to current job conditions.

If there have been any employee complaints of symptoms which may be attributable to exposure to lead or if there is any other information or observations which would indicate employee exposure to lead, this must also be considered as part of the initial determination.

If this initial determination shows that a reasonable possibility exists

that any employee may be exposed, without regard to respirators, over the action level, your employer must set up an air monitoring program to determine the exposure level representative of each employee exposed to lead at your workplace. In carrying out this air monitoring program, your employer is not required to monitor the exposure of every employee, but he or she must monitor a representative number of employees and job types. Enough sampling must be done to enable each employee's exposure level to be reasonably represent full shift exposure. In addition, these air samples must be taken under conditions which represent each employee's regular, daily exposure to lead. Sampling performed in the past 12 months may be used to determine exposures above the action level if such sampling was conducted during work activities essentially similar to present work conditions.

The standard lists certain tasks which may likely result in exposures to lead in excess of the PEL and, in some cases, exposures in excess of 50 times the PEL. If you are performing any of these tasks, your employer must provide you with appropriate respiratory protection, protective clothing and equipment, change areas, hand washing facilities, biological monitoring, and training until such time that an exposure assessment is conducted which demonstrates that your exposure level is below the PEL.

If you are exposed to lead and air sampling is performed, your employer is required to notify you in writing within 5 working days of the air monitoring results which represent your exposure. If the results indicate that your exposure exceeds the PEL (without regard to your use of a respirator), then your employer must also notify you of this in writing, and provide you with a description of the corrective action that has been taken or will be taken to reduce your exposure.

Your exposure must be rechecked by monitoring, at least every six months if your exposure is at or over the action level but below the PEL. Your employer may discontinue monitoring for you if 2 consecutive measurements, taken at least 7 days apart, are at or below the action level. Air monitoring must be repeated every 3 months if you are exposed over the PEL. Your employer must continue monitoring for you at this frequency until 2 consecutive measurements, taken at least 7 days apart, are below the PEL but above the action level, at which time your employer must repeat monitoring of your exposure every six months and may discontinue monitoring only after your exposure drops to or below the action level. However, whenever there is a change of equipment, process, control, or personnel or a new type of job is added at your workplace which may result in new or additional exposure to lead, your employer must perform additional monitoring.

III. Methods of Compliance - Paragraph (E)

Your employer is required to assure that no employee is exposed to lead in excess of the PEL as an 8-hour TWA. The interim final standard for lead in construction requires employers to institute engineering and work practice controls including administrative controls to the extent feasible to reduce employee exposure to lead. Where such controls are feasible but not adequate to reduce exposures below the PEL they must be used nonetheless to reduce exposures to the lowest level that can be accomplished by these means and then supplemented with appropriate respiratory protection.

Your employer is required to develop and implement a written compliance program prior to the commencement of any job where employee exposures may reach the PEL as an 8-hour TWA. The interim final standard identifies the various elements that must be included in the plan. For example, employers are required to include a description of operations in which lead is emitted, detailing other relevant information about the operation such as the type of equipment used, the type of material involved, employee job responsibilities, operating procedures and maintenance practices. In addition, your employer's compliance plan must specify the means that will be used to achieve compliance and, where engineering controls are required,

include any engineering plans or studies that have been used to select the control methods. If administrative controls involving job rotation are used to reduce employee exposure to lead, the job rotation schedule must be included in the compliance plan. The plan must also detail the type of protective clothing and equipment, including respirators, housekeeping and hygiene practices that will be used to protect you from the adverse effects of exposure to lead.

The written compliance program must be made available, upon request, to affected employees and their designated representatives, the Assistant Secretary and the Director.

Finally, the plan must be reviewed and updated at least every 6 months to assure it reflects the current status in exposure control.

IV. Respiratory Protection - Paragraph (F)

Your employer is required to provide and assure your use of respirators when your exposure to lead is not controlled below the PEL by other means. The employer must pay the cost of the respirator. Whenever you request one, your employer is also required to provide you a respirator even if your air exposure level is not above the PEL. You might desire a respirator when, for example, you have received medical advice that your lead absorption should be decreased. Or, you may intend to have children in the near future, and want to reduce the level of lead in your body to minimize adverse reproductive effects. While respirators are the least satisfactory means of controlling your exposure, they are capable of providing significant protection if properly chosen, fitted, worn, cleaned, maintained, and replaced when they stop providing adequate protection.

Your employer is required to select respirators from the types listed in Table I of the Respiratory Protection section of the standard. Any respirator chosen must be approved by the Mine Safety and Health Administration (MSHA) or the National Institute for Occupational Safety and Health (NIOSH). This respirator selection table will enable your employer to choose a type of respirator which will give you a proper amount of protection based on your airborne lead exposure. Your employer may select a type of respirator that provides greater protection than that required by the standard; that is, one recommended for a higher concentration of lead than is present in your workplace. For example, a powered air purifying respirator (PAPR) is much more protective than a typical negative pressure respirator, and may also be more comfortable to wear. A PAPR has a filter, cartridge or canister to clean the air, and a power source which continuously blows filtered air into your breathing zone. Your employer might make a PAPR available to you to ease the burden of having to wear a respirator for long periods of time. The standard provides that you can obtain a PAPR upon request.

Your employer must also start a Respiratory Protection Program. This program must include written procedures for the proper selection, use, cleaning, storage, and maintenance of respirators.

Your employer is required to select respirators from the types listed in Table I of the Respiratory Protection section of the standard (Sec. 1926.62 (f)). Any respirator chosen must be approved by the National Institute for Occupational Safety and Health (NIOSH) under the provisions of 42 CFR part 84. This respirator selection table will enable your employer to choose a type of respirator that will give you a proper amount of protection based on your airborne lead exposure. Your employer may select a type of respirator that provides greater protection than that required by the standard; that is, one recommended for a higher concentration of lead than is present in your workplace. For example, a powered air-purifying respirator (PAPR) is much more protective than a typical negative pressure respirator, and may also be more comfortable to wear. A PAPR has a filter, cartridge, or

canister to clean the air, and a power source that continuously blows filtered air into your breathing zone. Your employer might make a PAPR available to you to ease the burden of having to wear a respirator for long periods of time. The standard provides that you can obtain a PAPR upon request.

You must also receive from your employer proper training in the use of respirators. Your employer is required to teach you how to wear a respirator, to know why it is needed, and to understand its limitations.

Your employer must ensure that your respirator facepiece fits properly. Proper fit of a respirator facepiece is critical to your protection from airborne lead. Obtaining a proper fit on each employee may require your employer to make available several different types of respirator masks. To ensure that your respirator fits properly and that facepiece leakage is minimal, your employer must give you either a qualitative or quantitative fit test as specified in Appendix A of the Respiratory Protection standard located at 29 CFR 1910.134.

The standard provides that if your respirator uses filter elements, you must be given an opportunity to change the filter elements whenever an increase in breathing resistance is detected. You also must be permitted to periodically leave your work area to wash your face and respirator facepiece whenever necessary to prevent skin irritation. If you ever have difficulty in breathing during a fit test or while using a respirator, your employer must make a medical examination available to you to determine whether you can safely wear a respirator. The result of this examination may be to give you a positive pressure respirator (which reduces breathing resistance) or to provide alternative means of protection.

V. Protective Work Clothing and Equipment - Paragraph (G)

If you are exposed to lead above the PEL as an 8-hour TWA, without regard to your use of a respirator, or if you are exposed to lead compounds such as lead arsenate or lead azide which can cause skin and eye irritation, your employer must provide you with protective work clothing and equipment appropriate for the hazard. If work clothing is provided, it must be provided in a clean and dry condition at least weekly, and daily if your airborne exposure to lead is greater than 200 $\mu\text{g}/\text{m}^3$. Appropriate protective work clothing and equipment can include coveralls or similar full-body work clothing, gloves, hats, shoes or disposable shoe coverlets, and face shields or vented goggles. Your employer is required to provide all such equipment at no cost to you. In addition, your employer is responsible for providing repairs and replacement as necessary, and also is responsible for the cleaning, laundering or disposal of protective clothing and equipment.

The interim final standard requires that your employer assure that you follow good work practices when you are working in areas where your exposure to lead may exceed the PEL. With respect to protective clothing and equipment, where appropriate, the following procedures should be observed prior to beginning work:

1. Change into work clothing and shoe covers in the clean section of the designated changing areas;
2. Use work garments of appropriate protective gear, including respirators before entering the work area; and
3. Store any clothing not worn under protective clothing in the designated changing area.

Workers should follow these procedures upon leaving the work area:

1. HEPA vacuum heavily contaminated protective work clothing while it is

still being worn. At no time may lead be removed from protective clothing by any means which result in uncontrolled dispersal of lead into the air;

2. Remove shoe covers and leave them in the work area;
3. Remove protective clothing and gear in the dirty area of the designated changing area. Remove protective coveralls by carefully rolling down the garment to reduce exposure to dust.
4. Remove respirators last; and
5. Wash hands and face.

Workers should follow these procedures upon finishing work for the day (in addition to procedures described above):

1. Where applicable, place disposal coveralls and shoe covers with the abatement waste;
2. Contaminated clothing which is to be cleaned, laundered or disposed of must be placed in closed containers in the change room.
3. Clean protective gear, including respirators, according to standard procedures;
4. Wash hands and face again. If showers are available, take a shower and wash hair. If shower facilities are not available at the work site, shower immediately at home and wash hair.

VI. Housekeeping - Paragraph (H)

Your employer must establish a housekeeping program sufficient to maintain all surfaces as free as practicable of accumulations of lead dust. Vacuuming is the preferred method of meeting this requirement, and the use of compressed air to clean floors and other surfaces is generally prohibited unless removal with compressed air is done in conjunction with ventilation systems designed to contain dispersal of the lead dust. Dry or wet sweeping, shoveling, or brushing may not be used except where vacuuming or other equally effective methods have been tried and do not work. Vacuums must be used equipped with a special filter called a high-efficiency particulate air (HEPA) filter and emptied in a manner which minimizes the reentry of lead into the workplace.

VII. Hygiene Facilities and Practices - Paragraph (I)

The standard requires that hand washing facilities be provided where occupational exposure to lead occurs. In addition, change areas, showers (where feasible), and lunchrooms or eating areas are to be made available to workers exposed to lead above the PEL. Your employer must assure that except in these facilities, food and beverage is not present or consumed, tobacco products are not present or used, and cosmetics are not applied, where airborne exposures are above the PEL. Change rooms provided by your employer must be equipped with separate storage facilities for your protective clothing and equipment and street clothes to avoid cross-contamination. After showering, no required protective clothing or equipment worn during the shift may be worn home. It is important that contaminated clothing or equipment be removed in change areas and not be worn home or you will extend your exposure and expose your family since lead from your clothing can accumulate in your house, car, etc.

Lunchrooms or eating areas may not be entered with protective clothing or equipment unless surface dust has been removed by vacuuming, downdraft booth, or other cleaning method. Finally, workers exposed above the PEL must wash both their hands and faces prior to eating, drinking, smoking or

applying cosmetics.

All of the facilities and hygiene practices just discussed are essential to minimize additional sources of lead absorption from inhalation or ingestion of lead that may accumulate on you, your clothes, or your possessions. Strict compliance with these provisions can virtually eliminate several sources of lead exposure which significantly contribute to excessive lead absorption.

VIII. Medical surveillance - Paragraph (J)

The medical surveillance program is part of the standard's comprehensive approach to the prevention of lead-related disease. Its purpose is to supplement the main thrust of the standard which is aimed at minimizing airborne concentrations of lead and sources of ingestion. Only medical surveillance can determine if the other provisions of the standard have effectively protected you as an individual. Compliance with the standard's provision will protect most workers from the adverse effects of lead exposure, but may not be satisfactory to protect individual workers (1) who have high body burdens of lead acquired over past years, (2) who have additional uncontrolled sources of non-occupational lead exposure, (3) who exhibit unusual variations in lead absorption rates, or (4) who have specific non-work related medical conditions which could be aggravated by lead exposure (e.g., renal disease, anemia). In addition, control systems may fail, or hygiene and respirator programs may be inadequate. Periodic medical surveillance of individual workers will help detect those failures. Medical surveillance will also be important to protect your reproductive ability - regardless of whether you are a man or woman.

All medical surveillance required by the interim final standard must be performed by or under the supervision of a licensed physician. The employer must provide required medical surveillance without cost to employees and at a reasonable time and place. The standard's medical surveillance program has two parts -- periodic biological monitoring and medical examinations. Your employer's obligation to offer you medical surveillance is triggered by the results of the air monitoring program. Full medical surveillance must be made available to all employees who are or may be exposed to lead in excess of the action level for more than 30 days a year and whose blood lead level exceeds 40 ug/dl. Initial medical surveillance consisting of blood sampling and analysis for lead and zinc protoporphyrin must be provided to all employees exposed at any time (1 day) above the action level.

Biological monitoring under the standard must be provided at least every 2 months for the first 6 months and every 6 months thereafter until your blood lead level is below 40 ug/dl. A zinc protoporphyrin (ZPP) test is a very useful blood test which measures an adverse metabolic effect of lead on your body and is therefore an indicator of lead toxicity.

If your BLL exceeds 40 ug/dl the monitoring frequency must be increased from every 6 months to at least every 2 months and not reduced until two consecutive BLLs indicate a blood lead level below 40 ug/dl. Each time your BLL is determined to be over 40 ug/dl, your employer must notify you of this in writing within five working days of his or her receipt of the test results. The employer must also inform you that the standard requires temporary medical removal with economic protection when your BLL exceeds 50 ug/dl. (See Discussion of Medical Removal Protection - Paragraph (k).) Anytime your BLL exceeds 50 ug/dl your employer must make available to you within two weeks of receipt of these test results a second follow-up BLL test to confirm your BLL. If the two tests both exceed 50 ug/dl, and you are temporarily removed, then your employer must make successive BLL tests available to you on a monthly basis during the period of your removal.

Medical examinations beyond the initial one must be made available on an annual basis if your blood lead level exceeds 40 ug/dl at any time during

the preceding year and you are being exposed above the airborne action level of 30 ug/m³ for 30 or more days per year. The initial examination will provide information to establish a baseline to which subsequent data can be compared.

An initial medical examination to consist of blood sampling and analysis for lead and zinc protoporphyrin must also be made available (prior to assignment) for each employee being assigned for the first time to an area where the airborne concentration of lead equals or exceeds the action level at any time. In addition, a medical examination or consultation must be made available as soon as possible if you notify your employer that you are experiencing signs or symptoms commonly associated with lead poisoning or that you have difficulty breathing while wearing a respirator or during a respirator fit test. You must also be provided a medical examination or consultation if you notify your employer that you desire medical advice concerning the effects of current or past exposure to lead on your ability to procreate a healthy child.

Finally, appropriate follow-up medical examinations or consultations may also be provided for employees who have been temporarily removed from exposure under the medical removal protection provisions of the standard. (See Part IX, below.)

The standard specifies the minimum content of pre-assignment and annual medical examinations. The content of other types of medical examinations and consultations is left up to the sound discretion of the examining physician. Pre-assignment and annual medical examinations must include (1) a detailed work history and medical history; (2) a thorough physical examination, including an evaluation of your pulmonary status if you will be required to use a respirator; (3) a blood pressure measurement; and (4) a series of laboratory tests designed to check your blood chemistry and your kidney function. In addition, at any time upon your request, a laboratory evaluation of male fertility will be made (microscopic examination of a sperm sample), or a pregnancy test will be given.

The standard does not require that you participate in any of the medical procedures, tests, etc. which your employer is required to make available to you. Medical surveillance can, however, play a very important role in protecting your health. You are strongly encouraged, therefore, to participate in a meaningful fashion. The standard contains a multiple physician review mechanism which will give you a chance to have a physician of your choice directly participate in the medical surveillance program. If you are dissatisfied with an examination by a physician chosen by your employer, you can select a second physician to conduct an independent analysis. The two doctors would attempt to resolve any differences of opinion, and select a third physician to resolve any firm dispute. Generally your employer will choose the physician who conducts medical surveillance under the lead standard - unless you and your employer can agree on the choice of a physician or physicians. Some companies and unions have agreed in advance, for example, to use certain independent medical laboratories or panels of physicians. Any of these arrangements are acceptable so long as required medical surveillance is made available to workers.

The standard requires your employer to provide certain information to a physician to aid in his or her examination of you. This information includes (1) the standard and its appendices, (2) a description of your duties as they relate to occupational lead exposure, (3) your exposure level or anticipated exposure level, (4) a description of any personal protective equipment you wear, (5) prior blood lead level results, and (6) prior written medical opinions concerning you that the employer has. After a medical examination or consultation the physician must prepare a written report which must contain (1) the physician's opinion as to whether you have any medical condition which places you at increased risk of material impairment to health from exposure to lead, (2) any recommended special

protective measures to be provided to you, (3) any blood lead level determinations, and (4) any recommended limitation on your use of respirators. This last element must include a determination of whether you can wear a powered air purifying respirator (PAPR) if you are found unable to wear a negative pressure respirator.

The medical surveillance program of the interim lead standard may at some point in time serve to notify certain workers that they have acquired a disease or other adverse medical condition as a result of occupational lead exposure. If this is true, these workers might have legal rights to compensation from public agencies, their employers, firms that supply hazardous products to their employers, or other persons. Some states have laws, including worker compensation laws, that disallow a worker who learns of a job - related health impairment to sue, unless the worker sues within a short period of time after learning of the impairment. (This period of time may be a matter of months or years.) An attorney can be consulted about these possibilities. It should be stressed that OSHA is in no way trying to either encourage or discourage claims or lawsuits. However, since results of the standard's medical surveillance program can significantly affect the legal remedies of a worker who has acquired a job - related disease or impairment, it is proper for OSHA to make you aware of this.

The medical surveillance section of the standard also contains provisions dealing with chelation. Chelation is the use of certain drugs (administered in pill form or injected into the body) to reduce the amount of lead absorbed in body tissues. Experience accumulated by the medical and scientific communities has largely confirmed the effectiveness of this type of therapy for the treatment of very severe lead poisoning. On the other hand, it has also been established that there can be a long list of extremely harmful side effects associated with the use of chelating agents. The medical community has balanced the advantages and disadvantages resulting from the use of chelating agents in various circumstances and has established when the use of these agents is acceptable. The standard includes these accepted limitations due to a history of abuse of chelation therapy by some lead companies. The most widely used chelating agents are calcium disodium EDTA, (Ca Na₂ EDTA), Calcium Disodium Versenate (Versenate), and d-penicillamine (penicillamine or Cupramine).

The standard prohibits "prophylactic chelation" of any employee by any person the employer retains, supervises or controls. "Prophylactic chelation" is the routine use of chelating or similarly acting drugs to prevent elevated blood levels in workers who are occupationally exposed to lead, or the use of these drugs to routinely lower blood lead levels to predesignated concentrations believed to be "safe". It should be emphasized that where an employer takes a worker who has no symptoms of lead poisoning and has chelation carried out by a physician (either inside or outside of a hospital) solely to reduce the worker's blood lead level, that will generally be considered prophylactic chelation. The use of a hospital and a physician does not mean that prophylactic chelation is not being performed. Routine chelation to prevent increased or reduce current blood lead levels is unacceptable whatever the setting.

The standard allows the use of "therapeutic" or "diagnostic" chelation if administered under the supervision of a licensed physician in a clinical setting with thorough and appropriate medical monitoring. Therapeutic chelation responds to severe lead poisoning where there are marked symptoms. Diagnostic chelation involved giving a patient a dose of the drug then collecting all urine excreted for some period of time as an aid to the diagnosis of lead poisoning.

In cases where the examining physician determines that chelation is appropriate, you must be notified in writing of this fact before such treatment. This will inform you of a potentially harmful treatment, and allow you to obtain a second opinion.

IX. Medical Removal Protection - Paragraph (K)

Excessive lead absorption subjects you to increased risk of disease. Medical removal protection (MRP) is a means of protecting you when, for whatever reasons, other methods, such as engineering controls, work practices, and respirators, have failed to provide the protection you need. MRP involves the temporary removal of a worker from his or her regular job to a place of significantly lower exposure without any loss of earnings, seniority, or other employment rights or benefits. The purpose of this program is to cease further lead absorption and allow your body to naturally excrete lead which has previously been absorbed. Temporary medical removal can result from an elevated blood lead level, or a medical opinion. For up to 18 months, or for as long as the job the employee was removed from lasts, protection is provided as a result of either form of removal. The vast majority of removed workers, however, will return to their former jobs long before this eighteen month period expires.

You may also be removed from exposure even if your blood lead level is below 50 ug/dl if a final medical determination indicates that you temporarily need reduced lead exposure for medical reasons. If the physician who is implementing your employers medical program makes a final written opinion recommending your removal or other special protective measures, your employer must implement the physician's recommendation. If you are removed in this manner, you may only be returned when the doctor indicates that it is safe for you to do so.

The standard does not give specific instructions dealing with what an employer must do with a removed worker. Your job assignment upon removal is a matter for you, your employer and your union (if any) to work out consistent with existing procedures for job assignments. Each removal must be accomplished in a manner consistent with existing collective bargaining relationships. Your employer is given broad discretion to implement temporary removals so long as no attempt is made to override existing agreements. Similarly, a removed worker is provided no right to veto an employer's choice which satisfies the standard.

In most cases, employers will likely transfer removed employees to other jobs with sufficiently low lead exposure. Alternatively, a worker's hours may be reduced so that the time weighted average exposure is reduced, or he or she may be temporarily laid off if no other alternative is feasible.

In all of these situation, MRP benefits must be provided during the period of removal - i.e., you continue to receive the same earnings, seniority, and other rights and benefits you would have had if you had not been removed. Earnings includes more than just your base wage; it includes overtime, shift differentials, incentives, and other compensation you would have earned if you had not been removed. During the period of removal you must also be provided with appropriate follow-up medical surveillance. If you were removed because your blood lead level was too high, you must be provided with a monthly blood test. If a medical opinion caused your removal, you must be provided medical tests or examinations that the doctor believes to be appropriate. If you do not participate in this follow up medical surveillance, you may lose your eligibility for MRP benefits.

When you are medically eligible to return to your former job, your employer must return you to your "former job status." This means that you are entitled to the position, wages, benefits, etc., you would have had if you had not been removed. If you would still be in your old job if no removal had occurred that is where you go back. If not, you are returned consistent with whatever job assignment discretion your employer would have had if no removal had occurred. MRP only seeks to maintain your rights, not expand them or diminish them.

If you are removed under MRP and you are also eligible for worker compensation or other compensation for lost wages, your employer's MRP benefits obligation is reduced by the amount that you actually receive from these other sources. This is also true if you obtain other employment during the time you are laid off with MRP benefits.

The standard also covers situations where an employer voluntarily removes a worker from exposure to lead due to the effects of lead on the employee's medical condition, even though the standard does not require removal. In these situations MRP benefits must still be provided as though the standard required removal. Finally, it is important to note that in all cases where removal is required, respirators cannot be used as a substitute. Respirators may be used before removal becomes necessary, but not as an alternative to a transfer to a low exposure job, or to a lay-off with MRP benefits.

X. Employee Information and Training - Paragraph (L)

Your employer is required to provide an information and training program for all employees exposed to lead above the action level or who may suffer skin or eye irritation from lead compounds such as lead arsenate or lead azide. The program must train these employees regarding the specific hazards associated with their work environment, protective measures which can be taken, including the contents of any compliance plan in effect, the danger of lead to their bodies (including their reproductive systems), and their rights under the standard. All employees must be trained prior to initial assignment to areas where there is a possibility of exposure over the action level.

This training program must also be provided at least annually thereafter unless further exposure above the action level will not occur.

XI. Signs - Paragraph (M)

The standard requires that the following warning sign be posted in work areas where the exposure to lead exceeds the PEL:

WARNING
LEAD WORK AREA
POISON
NO SMOKING OR EATING

These signs are to be posted and maintained in a manner which assures that the legend is readily visible.

XII. Recordkeeping - Paragraph (N)

Your employer is required to keep all records of exposure monitoring for airborne lead. These records must include the name and job classification of employees measured, details of the sampling and analytical techniques, the results of this sampling, and the type of respiratory protection being worn by the person sampled. Such records are to be retained for at least 30 years. Your employer is also required to keep all records of biological monitoring and medical examination results. These records must include the names of the employees, the physician's written opinion, and a copy of the results of the examination. Medical records must be preserved and maintained for the duration of employment plus 30 years. However, if the employee's duration of employment is less than one year, the employer need not retain that employee's medical records beyond the period of employment if they are provided to the employee upon termination of employment.

Recordkeeping is also required if you are temporarily removed from your job under the medical removal protection program. This record must include your name and social security number, the date of your removal and return, how the removal was or is being accomplished, and whether or not the reason for

the removal was an elevated blood lead level. Your employer is required to keep each medical removal record only for as long as the duration of an employee's employment.

The standard requires that if you request to see or copy environmental monitoring, blood lead level monitoring, or medical removal records, they must be made available to you or to a representative that you authorize. Your union also has access to these records. Medical records other than BLL's must also be provided upon request to you, to your physician or to any other person whom you may specifically designate. Your union does not have access to your personal medical records unless you authorize their access.

XIII. Observation of Monitoring - Paragraph (O)

When air monitoring for lead is performed at your workplace as required by this standard, your employer must allow you or someone you designate to act as an observer of the monitoring. Observers are entitled to an explanation of the measurement procedure, and to record the results obtained. Since results will not normally be available at the time of the monitoring, observers are entitled to record or receive the results of the monitoring when returned by the laboratory. Your employer is required to provide the observer with any personal protective devices required to be worn by employees working in the area that is being monitored. The employer must require the observer to wear all such equipment and to comply with all other applicable safety and health procedures.

XIV. Effective Date - Paragraph (P)

The standard's effective date is June 3, 1993. Employer obligations under the standard begin as of that date with full implementation of engineering controls as soon as possible but no later than within 4 months, and all other provisions completed as soon as possible, but no later than within 2 months from the effective date.

XV. For Additional Information

A. A copy of the interim standard for lead in construction can be obtained free of charge by calling or writing the OSHA Office of Publications, room N-3101, United States Department of Labor, Washington, D.C. 20210: Telephone (202) 219-4667.

B. Additional information about the standard, its enforcement, and your employer's compliance can be obtained from the nearest OSHA Area Office listed in your telephone directory under United States Government/Department of Labor.

[57 FR 26627, May 4, 1993, as amended at 58 FR 34218, June 24, 1993; 63 FR 1152, Jan. 8, 1998]

APPENDIX 8

OSHA Substance Data Sheet For Occupational Exposure To Lead

OSHA Standard 29 CFR 1926.62
Lead Exposure In Construction; Interim Final Rule

Substance Data Sheet for Occupational Exposure to Lead
29 CFR 1926.62 Appendix A

I. SUBSTANCE IDENTIFICATION

A. "Substance": Pure lead (Pb) is a heavy metal at room temperature and pressure and is a basic chemical element. It can combine with various other substances to form numerous lead compounds.

B. "Compounds Covered by the Standard": The word "lead" when used in this interim final standard means elemental lead, all inorganic lead compounds and a class of organic lead compounds called lead soaps. This standard does not apply to other organic lead compounds.

C. "Uses": Exposure to lead occurs in several different occupations in the construction industry, including demolition or salvage of structures where lead or lead - containing materials are present; removal or encapsulation of lead - containing materials, new construction, alteration, repair, or renovation of structures that contain lead or materials containing lead; installation of products containing lead. In addition, there are construction related activities where exposure to lead may occur, including transportation, disposal, storage, or containment of lead or materials containing lead on construction sites, and maintenance operations associated with construction activities.

D. "Permissible Exposure": The permissible exposure limit (PEL) set by the standard is 50 micrograms of lead per cubic meter of air (50 ug/m^3), averaged over an 8-hour workday.

E. "Action Level": The interim final standard establishes an action level of 30 micrograms of lead per cubic meter of air (30 ug/m^3), averaged over an 8-hour workday. The action level triggers several ancillary provisions of the standard such as exposure monitoring, medical surveillance, and training.

II. HEALTH HAZARD DATA

A. "Ways in which lead enters your body". When absorbed into your body in certain doses, lead is a toxic substance. The object of the lead standard is to prevent absorption of harmful quantities of lead. The standard is intended to protect you not only from the immediate toxic effects of lead, but also from the serious toxic effects that may not become apparent until years of exposure have passed. Lead can be absorbed into your body by inhalation (breathing) and ingestion (eating). Lead (except for certain organic lead compounds not covered by the standard, such as tetraethyl lead) is not absorbed through your skin. When lead is scattered in the air as a dust, fume, or mist it can be inhaled and absorbed through your lungs and upper respiratory tract. Inhalation of airborne lead is generally the most important source of occupational lead absorption. You can also absorb lead through your digestive system if lead gets into your mouth and is swallowed. If you handle food, cigarettes, chewing tobacco, or make-up which have lead on them or handle them with hands contaminated with lead, this will contribute to ingestion. A significant portion of the lead that you inhale or ingest gets into your blood stream. Once in your blood stream, lead is circulated throughout your body and stored in various organs and body tissues. Some of this lead is quickly filtered out of your body and excreted, but some remains in the blood and other tissues. As exposure to lead continues, the amount stored in your body will increase if you are absorbing more lead than your body is excreting. Even though you may not be aware of any immediate symptoms of disease, this lead stored in your tissues can be slowly causing irreversible damage, first to individual cells, then to your organs and whole body systems.

B. "Effects of overexposure to lead" - (1) "Short term (acute) overexposure". Lead is a potent, systemic poison that serves no known useful function once absorbed by your body. Taken in large enough doses, lead can kill you in a matter of days. A condition affecting the brain called acute encephalopathy may arise which develops quickly to seizures, coma, and death from cardiorespiratory arrest. A short term dose of lead can lead to acute encephalopathy. Short term occupational exposures of this magnitude are highly unusual, but not impossible. Similar forms of encephalopathy may, however, arise from extended, chronic exposure to lower doses of lead. There is no sharp dividing line between rapidly developing acute effects of lead, and chronic effects which take longer to acquire. Lead adversely affects numerous body systems, and causes forms of health impairment and disease which arise after periods of exposure as short as days or as long as several years.

(2) "Long-term (chronic) overexposure". Chronic overexposure to lead may result in severe damage to your blood - forming, nervous, urinary and reproductive systems. Some common symptoms of chronic overexposure include loss of appetite, metallic taste in the mouth, anxiety, constipation, nausea, pallor, excessive tiredness, weakness, insomnia, headache, nervous irritability, muscle and joint pain or soreness, fine tremors, numbness, dizziness, hyperactivity and colic. In lead colic there may be severe abdominal pain. Damage to the central nervous system in general and the brain (encephalopathy) in particular is one of the most severe forms of lead poisoning. The most severe, often fatal, form of encephalopathy may be preceded by vomiting, a feeling of dullness progressing to drowsiness and stupor, poor memory, restlessness, irritability, tremor, and convulsions. It may arise suddenly with the onset of seizures, followed by coma, and death. There is a tendency for muscular weakness to develop at the same time. This weakness may progress to paralysis often observed as a characteristic "wrist drop" or "foot drop" and is a manifestation of a disease to the nervous system called peripheral neuropathy. Chronic overexposure to lead also results in kidney disease with few, if any, symptoms appearing until extensive and most likely permanent kidney damage has occurred. Routine laboratory tests reveal the presence of this kidney disease only after about two-thirds of kidney function is lost. When overt symptoms of urinary dysfunction arise, it is often too late to correct or prevent worsening conditions, and progression to kidney dialysis or death is possible. Chronic overexposure to lead impairs the reproductive systems of both men and women. Overexposure to lead may result in decreased sex drive, impotence and sterility in men. Lead can alter the structure of sperm cells raising the risk of birth defects. There is evidence of miscarriage and stillbirth in women whose husbands were exposed to lead or who were exposed to lead themselves. Lead exposure also may result in decreased fertility, and abnormal menstrual cycles in women. The course of pregnancy may be adversely affected by exposure to lead since lead crosses the placental barrier and poses risks to developing fetuses. Children born of parents either one of whom were exposed to excess lead levels are more likely to have birth defects, mental retardation, behavioral disorders or die during the first year of childhood. Overexposure to lead also disrupts the blood - forming system resulting in decreased hemoglobin (the substance in the blood that carries oxygen to the cells) and ultimately anemia. Anemia is characterized by weakness, pallor and fatigability as a result of decreased oxygen carrying capacity in the blood.

(3) "Health protection goals of the standard". Prevention of adverse health effects for most workers from exposure to lead throughout a working lifetime requires that a worker's blood lead level (BLL, also expressed as PbB) be maintained at or below forty micrograms per deciliter of whole blood (40 ug/dl). The blood lead levels of workers (both male and female workers) who intend to have children should be maintained below 30 ug/dl to minimize adverse reproductive health effects to the parents and to the developing fetus. The measurement of your blood lead level (BLL) is the most useful

indicator of the amount of lead being absorbed by your body. Blood lead levels are most often reported in units of milligrams (mg) or micrograms (ug) of lead (1 mg=1000 ug) per 100 grams (100 g), 100 milliliters (100 ml) or deciliter (dl) of blood. These three units are essentially the same. Sometime BLLs are expressed in the form of mg percent or ug percent. This is a shorthand notation for 100g, 100 ml, or dl. (References to BLL measurements in this standard are expressed in the form of ug/dl.)

BLL measurements show the amount of lead circulating in your blood stream, but do not give any information about the amount of lead stored in your various tissues. BLL measurements merely show current absorption of lead, not the effect that lead is having on your body or the effects that past lead exposure may have already caused. Past research into lead - related diseases, however, has focused heavily on associations between BLLs and various diseases. As a result, your BLL is an important indicator of the likelihood that you will gradually acquire a lead - related health impairment or disease.

Once your blood lead level climbs above 40 ug/dl, your risk of disease increases. There is a wide variability of individual response to lead, thus it is difficult to say that a particular BLL in a given person will cause a particular effect. Studies have associated fatal encephalopathy with BLLs as low as 150 ug/dl. Other studies have shown other forms of diseases in some workers with BLLs well below 80 ug/dl. Your BLL is a crucial indicator of the risks to your health, but one other factor is also extremely important. This factor is the length of time you have had elevated BLLs. The longer you have an elevated BLL, the greater the risk that large quantities of lead are being gradually stored in your organs and tissues (body burden). The greater your overall body burden, the greater the chances of substantial permanent damage. The best way to prevent all forms of lead - related impairments and diseases -- both short term and long term -- is to maintain your BLL below 40 ug/dl. The provisions of the standard are designed with this end in mind.

Your employer has prime responsibility to assure that the provisions of the standard are complied with both by the company and by individual workers. You, as a worker, however, also have a responsibility to assist your employer in complying with the standard. You can play a key role in protecting your own health by learning about the lead hazards and their control, learning what the standard requires, following the standard where it governs your own actions, and seeing that your employer complies with provisions governing his or her actions.

(4) "Reporting signs and symptoms of health problems". You should immediately notify your employer if you develop signs or symptoms associated with lead poisoning or if you desire medical advice concerning the effects of current or past exposure to lead or your ability to have a healthy child. You should also notify your employer if you have difficulty breathing during a respirator fit test or while wearing a respirator. In each of these cases, your employer must make available to you appropriate medical examinations or consultations. These must be provided at no cost to you and at a reasonable time and place. The standard contains a procedure whereby you can obtain a second opinion by a physician of your choice if your employer selected the initial physician.

[57 FR 26627, May 4, 1993, as amended at 58 FR 34218, June 24, 1993]

APPENDIX 9

Overview of EPA and State Requirements

Certification and Interim Controls

Waste

EPA AND STATE CERTIFICATION PROGRAMS AND THEIR TREATMENT OF INTERIM CONTROLS

I. EPA and State Certification. On March 1, 2000, the training and certification requirements of TSCA section 402 were in full effect in the Federal program operating in non-authorized States and Tribes. All individuals and firms performing "lead-based paint activities" as defined in 745.223 must be certified under 745.226 and must perform lead-based paint activities according to the work practice standards in 745.227.

EPA has developed regulations under TSCA sections 402/404 covering individuals and firms who are conducting lead-based paint activities in target housing and child-occupied facilities. Lead-based paint activities include inspection, risk assessment, and abatement. The requirements that individuals and firms must meet depend where they wish to work. Some States and Indian tribes are running their own programs that were authorized by EPA ("EPA-authorized programs"). In other States and Tribes that do not have an authorized program, EPA is running the program ("Federal program").

On March 1, 2000, EPA's Federal program under 40 CFR part 745 subpart L became fully affective in every State and Tribe that did not already have an EPA-approved authorized program in operation. Therefore, since March 1, 2000, anyone conducting inspections, risk assessments and/or abatements in target housing or child-occupied facilities has been subject to training, certification and work practice standard requirements either under EPA's Federal Program or an EPA-authorized State or Tribal program.

In EPA's Federal program, individuals who want to work as inspectors, risk assessors, abatement supervisors, abatement workers, and/or project designers, must be certified first. Each of the five disciplines has different education, experience and training requirements. Individuals who wish to be certified as inspectors, risk assessors, or abatement supervisors must also take a third party certification exam. Certification is granted after individuals have sent in an application indicating they have completed an accredited training course, met any other qualifications, and sent in a certification fee. Certified individuals agree to follow EPA's work practice standards. EPA's federal program also requires that firms whose employees conduct lead-based paint activities also be certified. In the EPA application, the firm agrees (1) to use only certified employees for inspection, risk assessment and abatement; (2) to use the work practice standards that EPA requires; and (3) to keep appropriate records.

Some EPA-authorized programs (State Lead Programs) may have certification requirements for different individual disciplines than EPA's Federal program and may or may not certify firms. There may also be differences in the types of activities regulated by EPA-authorized programs. For this reason, it is important for individuals and firms to understand the specific regulations that apply in the locations where they intend to work.

II. Qualification for Interim Controls. EPA, under the Federal program, does not regulate interim controls. However, EPA-authorized State and Tribal programs may regulate interim controls. Therefore, it is important for individuals and firms to review the specific regulations for the locations where they will be working.

HUD's Lead Safe Housing rule requires individuals conducting interim controls to be trained in one of the acceptable training courses listed in the rule. Among courses listed are (1) an accredited lead-based paint abatement supervisor course, or (2) an accredited lead-based paint abatement worker course. Those two courses refer to courses accredited in EPA's Federal program or an EPA authorized program.

EPA-AUTHORIZED STATES

As of January 1, 2001, the following states operate their own lead programs:

Alabama	Mississippi
Arkansas	Missouri
California	New Hampshire
Colorado	New Jersey
Connecticut	North Carolina
Delaware	Ohio
District of Columbia	Oklahoma
Georgia	Oregon
Illinois	Pennsylvania
Indiana	Puerto Rico
Iowa	Rhode Island
Kansas	Tennessee
Kentucky	Texas
Louisiana	Utah
Maine	Vermont
Maryland	Virginia
Massachusetts	West Virginia
Michigan	Wisconsin
Minnesota	

EPA LEAD PROGRAM STATES

As of January 1, 2001, the EPA operates the lead programs on behalf of the state:

Alaska, EPA Reg 10	New Mexico, EPA Reg 6
Arizona, EPA Reg 9	New York, EPA Reg 2
Florida, EPA Reg 4	North Dakota, EPA Reg 8
Guam, EPA Reg 9	South Carolina, EPA Reg 4
Hawaii, EPA Reg 9	South Dakota, EPA Reg 8
Idaho, EPA Reg 10	Virgin Islands, EPA Reg 2
Montana, EPA Reg 8	Washington, EPA Reg 10
Nebraska, EPA Reg 7	Wyoming, EPA Reg 8
Nevada, EPA Reg 9	

For more information and a list of state lead contacts, visit the web site of the National Conference of State Legislatures: www.ncsl.org/programs/ESNR/pplans-99.htm, or call 1-800-424-LEAD.

**EPA**United States
Environmental Protection AgencyOffice of Pollution Prevention
and Toxics**Lead-based Paint for Residential Contractors.
Lead-Based Paint is Household Waste.
August 2000****Agency Policy**

Aiming to further reduce lead poisoning in children, the Environmental Protection Agency (EPA) clarified that contractors can manage residential lead-based paint (LBP) waste as household waste. Allowing LBP waste to be managed this way makes it more affordable for people to reduce lead in and around their homes.

Contractor Waste

Residential contractors frequently work on residential dwellings like single family homes, apartment buildings, row houses, military barracks, or college dormitories. They routinely generate LBP waste during lead abatement, remodeling, or rehabilitation work on these residences. The waste consists mostly of building parts, such as doors, window frames, painted woodwork, and paint chips. Because the standards were unclear, contractors who needed to dispose of lead-based paint waste were uncertain about how to properly manage it.

EPA's policy statement allows contractor-generated LBP waste to be disposed of as household waste. Household waste is regular garbage or trash that is disposed of as municipal waste, and managed according to state and local requirements. Residents are already entitled to manage their own LBP waste in this manner. Extending this option to contractors simplifies abatement work and lowers its cost, which will allow more lead paint removal from more homes nationwide. Consequently, people's homes everywhere will be safer for both children and adults.

Safe Handling

EPA encourages everyone who handles lead-based paint to follow several common sense measures:

Collect paint chips, dust, dirt, and rubble in plastic trash bags for disposal. Store larger LBP building parts in containers until ready for disposal. If possible, use a covered mobile dumpster (such as a roll-off container) to store LBP debris until the job is done. Contact local solid waste authorities to determine where and how LBP debris can be disposed of.

The Toxic Substances Control Act (TSCA) contains training and certification requirements that contractors also should learn and follow. These requirements are under TSCA 402/404, and can be found on the Internet at <http://www.epa.gov/lead/leadcert.htm>. Note also that the US Department of Housing and Urban Development (HUD) established guidelines for contractors performing lead-based paint activities (see <http://www.hud.gov/lea/learules.html>).

Proposed TSCA Standards

EPA intends to pursue additional measures to promote LBP abatement activities. For example, in 1998 the Agency proposed new standards under TSCA that would replace existing Resource Conservation and Recovery Act (RCRA) hazardous waste regulations covering the disposal of LBP. This change, if adopted, would provide greater waste management flexibility and efficiency in numerous circumstances where lead-based paint is generated. Full details of the LBP proposal are available on the Internet at <http://www.epa.gov/lead>.

For More Information

For general information on lead-based paint and lead-based paint hazards, call the National Lead Information Center at 1 800 424 LEAD (5323). You may also obtain information by calling the RCRA Hotline. Callers within the Washington Metropolitan Area must dial 703-412-9810 or TDD 703-412-3323 (hearing impaired). Long-distance callers may call 1-800-424-9346 or TDD 1-800-553-7672. The RCRA Hotline operates weekdays, 9:00 a.m. to 6:00 p.m. Write to the RCRA Information Center (5305W), US EPA, Ariel Rios Building, 1200 Pennsylvania Avenue, NW, Washington, DC 20460.

July 31, 2000

MEMORANDUM

From: /s/ Elizabeth A. Cotsworth, Director
Office of Solid Waste

To: RCRA Senior Policy Advisors
EPA Regions 1 - 10

Subject: Regulatory Status of Waste Generated by Contractors and Residents from Lead-Based Paint Activities Conducted in Households

What is the purpose of this interpretation?

This memorandum clarifies the regulatory status of waste generated as a result of lead-based paint (LBP) activities (including abatement, renovation and remodeling) in homes and other residences. Since 1980, EPA has excluded "household waste" from the universe of RCRA hazardous wastes under 40 CFR 261.4(b)(1). In the 1998 temporary toxicity characteristic (TC) suspension proposal, we clarified that the household waste exclusion applies to "all LBP waste generated as a result of actions by residents of households (hereinafter referred to as "residents") to renovate, remodel or abate their homes on their own." 63 FR 70233, 70241 (Dec. 18, 1998). In this memorandum, EPA is explaining that we believe lead paint debris generated by contractors in households is also "household waste" and thus excluded from the RCRA Subtitle C hazardous waste regulations. Thus, the household exclusion applies to waste generated by either residents or contractors conducting LBP activities in residences.

What is the practical significance of classifying LBP waste as a household waste?

As a result of this clarification, contractors may dispose of hazardous-LBP wastes from residential lead paint abatements as household garbage subject to applicable State regulations. This practice will simplify many lead abatement activities and reduce their costs. In this way, the clarification in today's memorandum will facilitate additional residential abatement, renovation and remodeling, and rehabilitation activities, thus protecting children from continued exposure to lead paint in homes and making residential dwellings lead safe for children and adults.

LBP debris (such as architectural building components -- doors, window frames, painted wood work) that do not exhibit the TC for lead need not be managed as hazardous waste. However, LBP waste such as debris, paint chips, dust, and sludges generated from abatement and deleading activities that exhibit the TC for lead (that is, exceed the TC regulatory limit of 5 mg/L lead in the waste leachate), are hazardous wastes and must be managed and disposed of in accordance with the applicable RCRA subtitle C requirements (including land disposal restrictions) except when it is "household waste." Under 40 CFR 261.4(b)(1), household wastes are excluded from the hazardous waste management requirements. Today, EPA is clarifying that waste generated as part of LBP activities conducted at residences (which include single family homes, apartment buildings, public housing, and military barracks) is also household waste, that such wastes are no longer hazardous wastes and that such wastes thus are excluded from RCRA's hazardous

waste management and disposal regulations. Generators of residential LBP waste do not have to make a RCRA hazardous waste determination. This interpretation holds regardless of whether the waste exhibits the toxicity characteristic or whether the LBP activities were performed by the residents themselves or by a contractor.

Where can I dispose of my household LBP waste?

LBP waste from residences can be discarded in a municipal solid waste landfill (MSWLF) or a municipal solid waste combustor. Dumping and open burning of residential LBP waste is not allowed. Certain LBP waste (such as large quantities of concentrated lead paint waste -- paint chips, dust, or sludges) from residential deleading activities may be subject to more stringent requirements of State, local, and/or tribal authorities.

What is the basis for this interpretation?

The household waste exclusion implements Congress's intent that the hazardous waste regulations are "not to be used either to control the disposal of substances used in households or to extend control over general municipal wastes based on the presence of such substances." S. Rep. No. 94-988, 94th Cong., 2nd Sess., at 16. EPA regulations define "household waste" to include "any waste material (including garbage, trash, and sanitary wastes in septic tanks) derived from households (including single and multiple residences, hotels and motels, bunkhouses, ranger stations, crew quarters, campgrounds, picnic grounds and day-use recreation areas)." 40 CFR 261.4(b)(1). The Agency has applied two criteria to define the scope of the exclusion: (1) the waste must be generated by individuals on the premises of a household, and (2) the waste must be composed primarily of materials found in the wastes generated by consumers in their homes (49 FR 44978 and 63 FR 70241).

In 1998, EPA concluded that LBP waste resulting from renovation and remodeling efforts by residents of households met these criteria. (63 FR 70241-42, Dec. 18, 1998). In short, the Agency found that more and more residents are engaged in these activities and thus the waste can be considered to be generated by individuals in a household and of the type that consumers generate routinely in their homes. Wastes from LBP abatements performed by residents were also considered household wastes.

EPA clarifies that this interpretation also applies to contractor-generated LBP waste from renovations, remodeling and abatements in residences. Both the definition of household waste in section 261.4(b)(1) and the Agency's criteria for determining the scope of the exclusion focus on the type of waste generated and the place of generation rather than who generated the waste (e.g., a resident or a contractor). This approach is consistent with prior Agency policy.¹ Since

¹In the final rule establishing standards for the tracking and management of medical waste, EPA concluded that waste generated by health care providers (e.g., contractors) in private homes would be covered by the household waste exclusion. 54 FR 12326, 12339 (March 24, 1989). In the specific context of LBP, the Agency stated in a March 1990 "EPA Hotline Report" (RCRA Question 6) that lead paint chips and dust resulting from stripping and re-painting of residential walls by homeowner or contractors (as part of routine household maintenance) would be part of the household waste stream and not subject to RCRA Subtitle C regulations. Similarly, in a March 1995 memorandum on the "Applicability of the Household Waste Exclusion to Lead- Contaminated Soils," we found that if the source of the lead contamination was as a result of either routine residential maintenance or the weathering or chalking of lead-based paint from the residence, the hazardous waste regulations do not apply so long as the lead-contaminated soil is managed onsite or disposed offsite according to applicable solid waste regulations and/or State

contractor-generated LBP waste from residential renovations, remodeling, rehabilitation, and abatements are of the type generated by consumers in their homes, it is appropriate to conclude that such waste, whether generated by a resident or contractor, falls within the household waste exclusion. This clarification will facilitate lead abatements and deleading activities in target housing by reducing the costs of managing and disposing of LBP waste from residences.

What is the relationship of this interpretation to the on-going LBP debris rulemaking?

On December 18, 1998, EPA proposed new TSCA standards for management and disposal of LBP debris (63 FR 70190) and simultaneously proposed to suspend temporarily the applicability of the RCRA hazardous waste regulations that currently apply to LBP debris (63 FR 70233). This memorandum responds to stakeholders requests that EPA clarify whether the existing household waste exclusion applies to both homeowners and contractors conducting LBP activities in residences. While the Agency still intends to finalize aspects of the two proposals, we are making this clarification in advance of the final rule to facilitate LBP abatement in residences without unnecessary delay.

How does this interpretation affect EPA's enforcement authorities?

Under this clarification, LBP wastes generated by residents or contractors from the renovation, remodeling, rehabilitation, and/or abatement of residences are household wastes that are excluded from EPA's hazardous waste requirements in 40 CFR Parts 124, and 262 through 271. The household waste provision of 40 CFR 261.4(b)(1) only excludes such wastes from the RCRA regulatory requirements. However, it does not affect EPA's ability to reach those wastes under its statutory authorities, such as RCRA §3007 (inspection) and §7003 (imminent hazard). See 40 CFR §261.1(b).

What are the "best management practices" for handling residential LBP waste?

Although excluded from the hazardous waste regulations, EPA encourages residents and contractors managing LBP waste from households to take common sense measures to minimize the generation of lead dust, limit access to stored LBP wastes including debris, and maintain the integrity of waste packaging material during transfer of LBP waste. In particular, we continue to endorse the basic steps outlined in the 1998 proposals for the proper handling and disposal of LBP waste (63 FR 70242) as the best management practices (BMPs) including:

- ☞ Collect paint chips and dust, and dirt and rubble in plastic trash bags for disposal.
- ☞ Store larger LBP architectural debris pieces in containers until ready for disposal.
- ☞ Consider using a covered mobile dumpster (such as a roll-off container) for storage of LBP debris until the job is done.
- ☞ Contact local municipalities or county solid waste offices to determine where and how LBP debris can be disposed.

In addition, contractors working in residential dwellings are subject to either one or both of the following:

law mandated by RCRA.

- ☞ The HUD Guidance for contractors doing publically-funded rehabilitation/renovation projects in public housing. (See Guidelines for the Evaluation and Control of Lead-Based Paint Hazards in Housing. U.S. Department of Housing and Urban Development, June 1995) The HUD guidelines can be accessed via the Internet at: <http://www.hud.gov/lea/learules.html>
- ☞ TSCA 402/404 training and certification requirements. (See 40 CFR Part 745; 61 FR 45778, August 29, 1996) and the proposed TSCA onsite management standards (See 40 CFR Part 745, Subpart P; 63 FR 70227 - 70230, Dec. 18, 1998). [EPA expects to issue the final rule next year.]

The above-mentioned BMPs for households are similar to those included in the HUD Guidelines for individuals controlling LBP hazards in housing. HUD requires that contractors using HUD funding adhere to LBP hazard control guidelines. Non-adherence to these guidelines can potentially result in the loss of funding.

Does this interpretation apply in my State and/or locality?

We encourage contractors and residents to contact their state, local and/or tribal government to determine whether any restrictions apply to the disposal of residential LBP waste. This verification is necessary since, under RCRA, States, local and tribal governments can enforce regulations that are more stringent or broader in scope than the federal requirements. Thus, under such circumstances, LBP waste from households may still be regulated as a hazardous waste as a matter of State regulations.

We are distributing this memorandum to all 56 States and Territories, and Tribal Programs and various trade associations. We encourage States to arrange for implementation of the interpretation discussed in this memo in their States to facilitate residential LBP abatements making residential dwellings lead-safe. We encourage trade associations to inform their memberships about this memo and instruct them about ways to manage residential LBP waste.

Whom should I contact for more information?

If you have additional questions concerning the regulatory status of waste generated from lead-based paint activities in residences, please contact Ms. Rajani D. Joglekar of my staff at 703/308-8806 or Mr. Malcolm Woolf of the EPA General Counsel's Office at 202/564-5526.

- cc: Key RCRA Contacts, Regions 1 - 10
RCRA Regional Council Contacts, Regions 1 - 10
RCRA Enforcement Council Contacts, Regions 1 - 10
Association of State and Territorial Solid Waste Management Officials (ASTSWMO)

APPENDIX 10

Supervisory and Business Issues

Appendix 10

Supervisory and Business Issues

02/23/2001



U.S. Department of Housing
and Urban Development

10 - 1

Lesson Overview

- ◆ **Key supervisor responsibilities**
- ◆ **Benefits of performing work in a lead-safe manner**

02/23/2001



10 - 2

- In addition to understanding how to perform renovation, remodeling, and rehabilitation work in a lead safe manner, supervisors must also be aware of a number of other issues. This appendix will highlight those issues as well as the benefits of performing work in a lead safe manner.

289

02/23/2001

10-2

Key Supervisor Responsibilities

- ◆ Stay informed
- ◆ Ensure job performance
- ◆ Manage liability
- ◆ Manage works
- ◆ Maintain records

02/23/2001



U.S. Department of Housing
and Urban Development

10 - 3

- Key supervisor responsibilities are discussed in detail on the following slides.

290

Stay Informed

- ◆ State and local regulations pertaining to LBP
- ◆ OSHA requirements for worker safety
- ◆ Waste management and disposal requirements

02/23/2001



10 - 4

State and Local Regulations

- As noted earlier, states and local jurisdictions (e.g., counties and cities) may have additional requirements for working on homes with lead-based paint. Supervisors must be familiar with these additional requirements to ensure that work is performed properly. The National Council of State Legislatures (NCSL) provides periodic updates to state laws affecting lead-based paint for all states. The 1999 compilation is located at: <http://www.ncsl.org/programs/ESNR/pblaw99.htm>

OSHA

- Although this training does not specifically address worker safety issues, supervisors are responsible for ensuring that their workers are properly trained and equipped to work on lead-based paint.

Waste Management and Disposal

- As indicated earlier in Module 5 (Cleanup and Check Your Work), state regulations for waste management and disposal vary and may be more stringent than federal requirements. Supervisors must be aware of state requirements. To find out about requirements, contact your state's department of environmental protection or equivalent. To access State hazardous waste websites go to <http://www.epa.gov/epaoswer/osw/stateweb.htm>. This website will point you to specific state sites.

291

02/23/2001

10-4

Job Performance

- ◆ Skill building
- ◆ Tool kits
- ◆ Planning
- ◆ Client education

02/23/2001



U.S. Department of Housing
and Urban Development

10 - 5

Skill building

- Supervisors must ensure that their workers have the necessary skills to accomplish the tasks they are expected to perform. For working on homes with lead-based paint, workers need to know how to contain and cleanup lead dust created while working.

Tool kits

- Supervisors should ensure that their workers have access to the tools and supplies necessary to perform their jobs in a manner

Planning

- Supervisors must be able to plan work on homes with lead-based paint to be efficient in using workers with the background and skills to accomplish the job. This requires a different set of specs than other jobs. Know who is allowed in which spaces. Planning also, as we saw in Module 2 (Planning) requires practice and skill in estimating the cost of jobs and determining what tasks will need to be performed, how they will be performed, by whom, and how long it will take to accomplish.

Client education

- Using the pamphlet *Protect Your Family From Lead In Your Home* as an opportunity to explain to your clients how you will do your work and how that will benefit your client. This information will assist in educating the client about lead-based paint and help to inform their expectations of the work that you do.

Tool Kits

- ◆ Setup
- ◆ PPE
- ◆ Safe Work Practices
- ◆ Clean-Up

02/23/2001



10 - 6

Tool kit tips

- Keep kits in separate, labeled containers
- Setup kit: knives, tape, protective sheeting, cones
- Personal Protection Equipment (PPE) kit: disposable coveralls, hat, gloves, respirators, purple HEPA filters, First Aid kit, shoe covers, safety glasses, ear protection for power tools
- Safe work practices kit: HEPA vacuum, other HEPA tools, box of brushes, wet/dry sandpaper
- Clean-Up: bottle mister, wet wipes, mop heads, mops, buckets, mop wringer
- Tools can be purchased from wholesale tool suppliers, and vendors can be found by looking online and searching the Internet.

293

02/23/2001

10-6

Liability Management

◆ Four methods to limit liability

- Achieve and document clearance
- Contract modifications
- Quality control
- Insurance

◆ Failure to comply with applicable regulations could expose contractors to liability

◆ Voluntary work practices presented in this training may create a new legal standard



U.S. Department of Housing
and Urban Development

02/23/2001

10 - 7

Liability Management

To avoid legal liability the supervisor should:

- Be familiar with industry standards and any applicable laws and regulations
- Train workers to handle LBP issues
- Provide explanation and records of work in written form, including any hazards to the client
- Give written job descriptions that specify tasks, methods, results, and time frame
- Be aware of new developments
- Provide close supervision of work site

Possible claimants include: clients, residents, health or regulatory agencies, workers and other contractors, and owners of neighboring properties.

Contract Modifications

Note that the work being performed is not abatement work. Contract modifications should be protective of contractor.

Contractors have a legal duty to

- Exercise reasonable care in performing work
- Warn clients of potential hazards
- Be informed about applicable standards and requirements

Supervisors have a duty to act as any reasonable, competent supervisor given the circumstances of the situation and in accordance with industry standards. Failure to do so can be used as evidence of negligence.

294

Scope of Work for Proposal

- ◆ Lead Paint Safety Field Guide
- ◆ Model Specifications
- ◆ HUD Guidelines
- ◆ Associations

02/23/2001



10 - 8

- Proposals for working in lead-safe manner will require a scope of work different from traditional jobs. The sources listed below can provide information about the activities for working in a home with lead-based paint that are different from working on traditional jobs in homes without lead-based paint.

Lead Paint Safety Field Guide

- The Field Guide can be found in Appendix 1 of this training. It will provide information that can help you identify the key activities to be performed when working on a home with lead-based paint.

Model specifications

- The National Center for Lead-Safe Housing has documents for contractors working on homes with lead-based paint. Information on how to obtain these model specifications is available on the internet at http://www.lead safehousing.org/html/lead_specs.html
- The National Institute of Building Sciences has Operations and Maintenance Guidelines. See www.nibs.org.

HUD Guidelines

- These guidelines, formally known as Guidelines for the Development and Control of Lead-Based Paint Hazards in Housing, are available on the internet at <http://www.hud.gov/lea/leadwnlo.html>

Associations

- Home construction and similar trade or professional associations can provide assistance, especially if you are a member.

295

02/23/2001

10-8

Insurance

◆ General liability insurance

- Certain state and local laws may require it
- Most policies contain a pollution exclusion clause

◆ Pollution liability insurance

◆ Errors and omissions insurance

- Typically for consultants, risk assessors, inspectors

02/23/2001



10 - 9

- See Appendix 5 for a discussion of types and uses of insurance.

Commercial General Liability (CGL) Insurance

- CGL Exclusion Section F
- CGL policies are readily available at reasonable cost, but typically specifically exclude coverage of pollution-related claims.
- Should include premises and operations liability, contractual liability, independent contractor liability, and products and completed operations liability.
- Try to get the policy endorsed to modify or eliminate the "pollution exclusion"
- The policy should be written on an "occurrence" basis. Occurrence policies require that there be bodily injury or property damage caused by an accident during the policy period, including continuous or repeated exposure to harmful conditions. There are no restrictions on when a resulting claim or suit must be made or brought against the insured, as there is in a "claims-made" policy.

Errors and Omissions (E&O) Insurance

- Covers professional services rendered, such as by a certified lead-based paint inspector, or a consultant.

Pollution Liability Insurance

- Usually attached to CGL or E&O insurance as a policy rider or written as a separate insurance policy altogether.

Work Crew Management

- ◆ **Personal protection equipment**
- ◆ **Match work crew skills to job requirements**
 - Lead and non-lead work environments
- ◆ **Daily oversight**
 - Daily quality control
 - Daily checking on cleaning

02/23/2001



10 - 10

Personal Protection Equipment

- Includes respirators (such as an N-100), work suits, hats, booties, etc.
- Not only will proper use of this equipment protect workers, but it will also protect clients and worker families from exposure to lead.
- Improper use of PPE can endanger workers.
- Proper training in use of personal protection equipment is essential to ensuring that the equipment will function as designed.

Skill Matching

- This includes ensuring that workers with specific types of training or skills are assigned to tasks that make use of those skills. For example, you would not assign sole responsibility for laying poly on the floor, covering vents, windows, and doors to a worker with no previous experience in setting up a room for renovation.

Daily Oversight

- Supervisors are responsible to make sure that workers at the work sites for which they are responsible are performing work in a manner consistent with containing dust and cleaning it up. Usually this involves spending time at the work site during the day to verify that work is progressing as planned.

297

02/23/2001

10-10

Records Maintenance

◆ Pamphlet

- Record of providing *Protect Your Family From Lead In Your Home* pamphlet required under the 406(b) rule

◆ Recommend review with client the punch list of work completed

02/23/2001



U.S. Department of Housing
and Urban Development

10 - 11

Client review

- Keeping a record of client approval of work performed can assist in building client confidence in your work as a contractor and also in managing your liability. The act of obtaining client approval is an opportunity for a positive interaction with the client.
- May be useful for liability protection as proof that contractor completed job and client was satisfied.
- Sign-off not always practical: final check clearing bank is legal proof of completion.
- Cleanup to a standard of no visible dust may be included in the punch list, and punch list may be reviewed with client at end of job.

Pamphlet

A copy of this pamphlet is in Appendix 3. Guidance on the 406(b) rule for contractors, property managers, and maintenance personnel is in Appendix 4. This consists of:

- Part I (Revised June 25, 1999)
- Correction and clarification of Part I regarding timing of pamphlet delivery (Jun 25, 1999)
- Part II (October 15, 1999)
- EPA Questions and Answers on the Pre-Renovation Lead Information Rule (TSCA 406(b)) (June 1998)

298

02/23/2001

10-11

Benefits of Using LBP Safe Practices

- ◆ **Reduced liability exposure**
- ◆ **Increased employee morale**
 - Safer work sites
 - Better worker health
- ◆ **Marketing benefit**
 - Differentiation from other contractors
 - Generate positive word-of-mouth and publicity
 - Market as higher quality work
 - Provide clients with peace of mind

02/23/2001



10 - 12

Reduced Liability Exposure

- Using work practices that minimize generation of LBP, contain LBP that is generated, and clean up LBP after completing the work is a critical element in demonstrating that you have performed the work in a reasonable manner, therefore reducing potential liability.

Employee Morale

- Efforts to ensure safer work sites; by extension, better worker health can improve worker morale and productivity.

Marketing Benefit

- Relying on the work practices discussed in this training will lead to satisfied and knowledgeable customers who will be happy to tell their friends about the work you did. It also allows you to differentiate your business from other contractors. Word-of-mouth advertising and increased visibility are key elements in being able to attract new business.
- Remember: Your bid may be higher, so you should be prepared to discuss why it makes sense to hire a more knowledgeable and experienced worker to perform renovation, remodeling, and rehabilitation.



*U.S. Department of Education
Office of Educational Research and Improvement (OERI)
National Library of Education (NLE)
Educational Resources Information Center (ERIC)*



NOTICE

Reproduction Basis

- This document is covered by a signed "Reproduction Release (Blanket)" form (on file within the ERIC system), encompassing all or classes of documents from its source organization and, therefore, does not require a "Specific Document" Release form.
- This document is Federally-funded, or carries its own permission to reproduce, or is otherwise in the public domain and, therefore, may be reproduced by ERIC without a signed Reproduction Release form (either "Specific Document" or "Blanket").